

# Systems

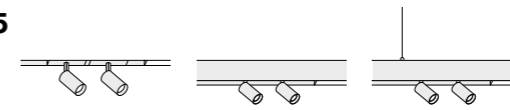

# Systems

## MOVE IT 25



694 recessed surface suspended

## MOVE IT 45

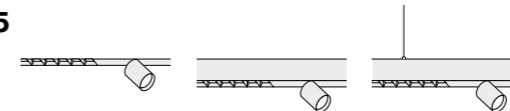

778 recessed surface suspended

## TASK

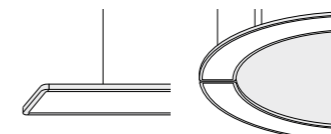

808 S suspended acoustic

## BETO



834 ceiling suspended

## SETA

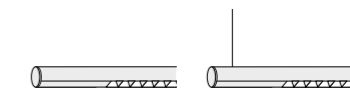

**NEW** 850 ceiling suspended

## LENO



858 recessed semi-recessed surface suspended

## MINIMAL



878 recessed

## FRAME

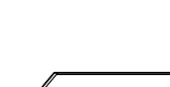

888 recessed trim

## CANYON



902 recessed offset

## MINO



908 ceiling suspended

## BASO



934 recessed surface

## TUBO



**NEW** 948 surface suspended

## LINEA



**NEW** 958 wall

# Everything on track



## MOVE IT 25 system

**EN** The sleek, elegant MOVE IT 25 system has revolutionised low-voltage track systems. The tool-free magnetic mounting of spotlights, decorative, or linear insets allows flexible, ever-new combinations. The various mounting options offer even more freedom: at two heights each, as trimless recessed and surface-mounted for wall or ceiling mounting, and suspended with a direct or direct / indirect light component. The individual profiles can be interconnected with each other, or linked via the CORNER, CURVE or NODE Connector elements. This allows for a variety of creative ceiling patterns. Square or triangular acoustic elements that can be optionally integrated additionally create balanced room acoustics.

**IT** Elegante ed essenziale, MOVE IT 25 rivoluziona il sistema dei binari elettrificati: tutte gli inserti luminosi, i faretto, i moduli lineari o decorativi, si fissano nei profili con un sistema magnetico e si spostano con facilità con combinazioni sempre nuove. Numerose anche le opzioni di montaggio: incasso senza cornice, plafone su pareti e soffitti, sospensione a due altezze, emissione solo diretta oppure diretta / indiretta. I singoli profili si collegano reciprocamente con giunti lineari, curve, angolari oppure con un NODE Connector. In questo modo si ottengono composizioni creative e personalizzate. In opzione si possono aggiungere pannelli fonoassorbenti quadrati o triangolari per migliorare l'acustica.

### Types



25 S

25

### Mountings

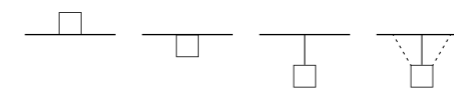
trimless  
recessed

surface

suspended

indirect  
suspended

### Configurations



linear

corner

curve

node

flextrack

### Light distributions

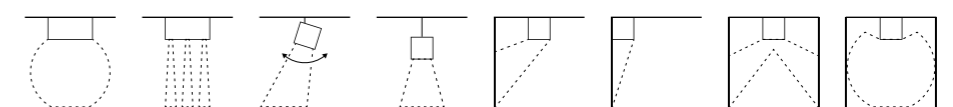

opal

spot line

spotlight

decorative

wallwasher

wall grazer

batwing

pivot

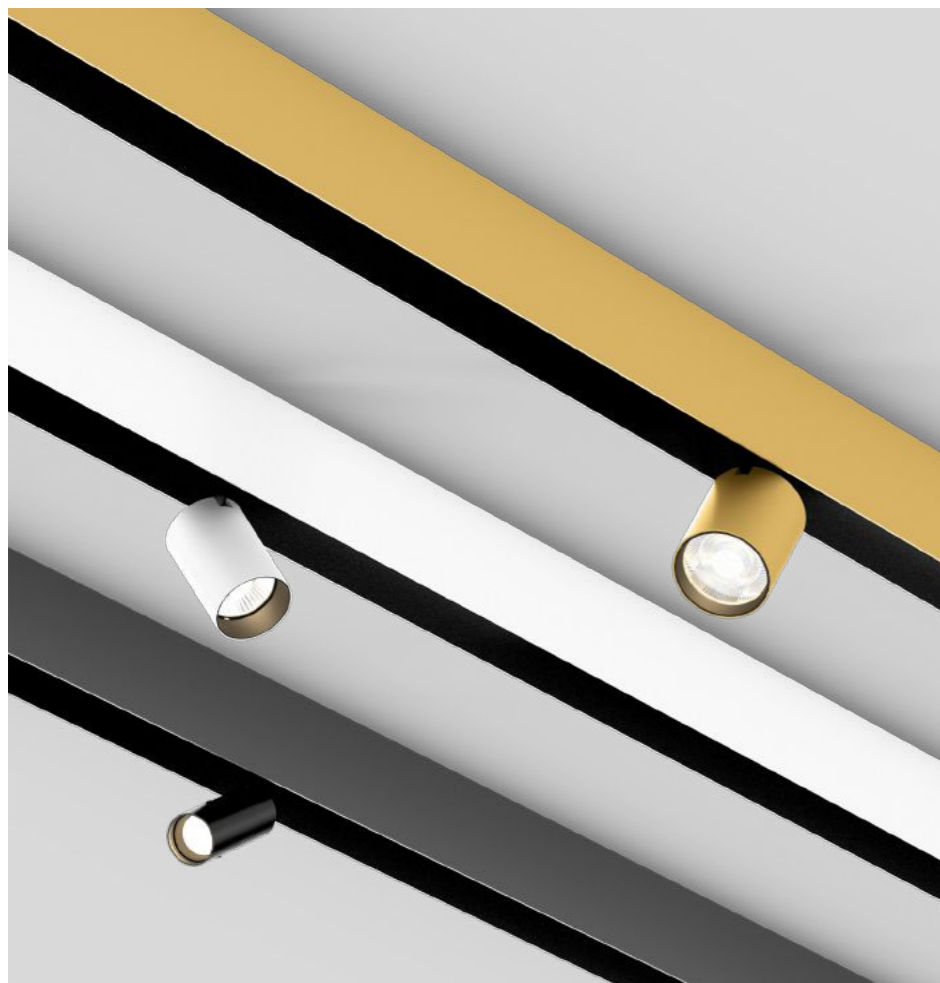

## Colour variety

EN MOVE IT profiles are available in the standard colours black, white, and gold. Further colour variations are also available, granting your project maximum design freedom. You can learn more about our colour palette at [xal.com/colours](http://xal.com/colours).

IT I profili MOVE IT sono disponibili in diversi colori standard. Oltre a questi, si possono scegliere anche altri colori speciali in modo da personalizzare il progetto. Per conoscere la gamma di colori consultate [xal.com/colours](http://xal.com/colours).



[xal.com/colours](http://xal.com/colours)

## Individual grids & room acoustics

EN The NODE Connector lets you create different ceiling patterns from up to six MOVE IT 25 profiles per node. Attractive geometric shapes are created by connecting the profiles at a 60° or 90° angle. Create seamless 90° corners with a special corner connector. Simply extend the MOVE IT Suspended System with triangular and square acoustic elements for optimised room acoustics. Curved elements and special corner connectors that are rotated 35° to the left and right provide even more design freedom.

IT Con il NODE Connector si compongono forme diversificate sul soffitto collegando fino a sei profili MOVE IT 25 per ogni snodo. Unendo i profili ad angoli di 60° o 90°, si ricavano corrispondenti forme geometriche. In aggiunta, quando si richiede il miglioramento acustico, si può integrare il sistema MOVE IT a sospensione aggiungendo pannelli fonoassorbenti triangolari e quadrati. La libertà compositiva aumenta con gli elementi ricurvi e con giunti angolari speciali che si ruotano di 35° a destra e sinistra.



## Mounting options

EN The slim, elegant MOVE IT 25 system offers a wide variety of installation options: as a trimless recessed or surface-mounted variant for wall or ceiling mounting and suspended at two depths. The direct/indirect variant provides additional homogeneous ceiling illumination.

IT MOVE IT 25 è un sistema slanciato ed elegante, con molte opzioni di montaggio: incasso senza cornice, plafone su pareti e soffitti, sospensione a due altezze. La variante a luce diretta/indiretta aggiunge una luminosità omogenea sul soffitto.

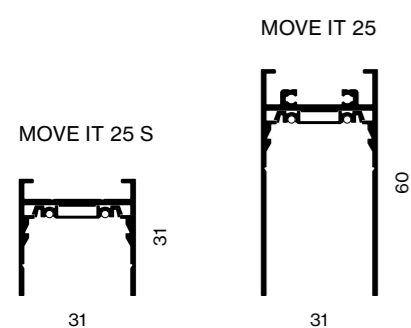
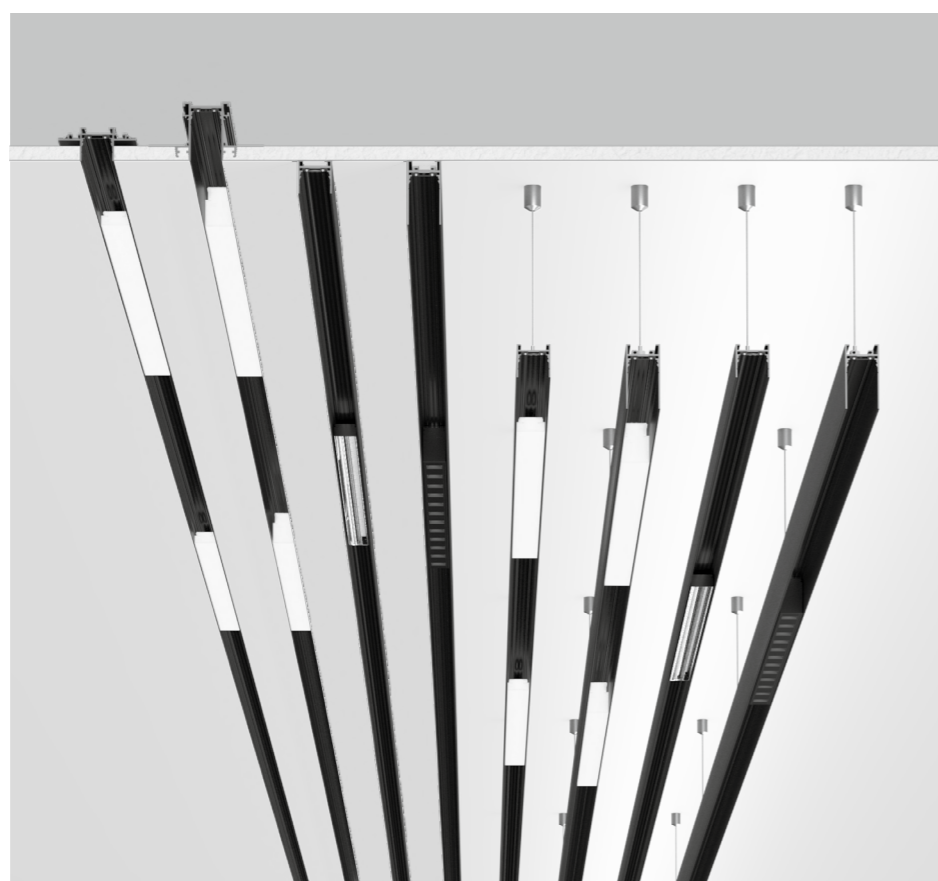

## XPECTRUM LED

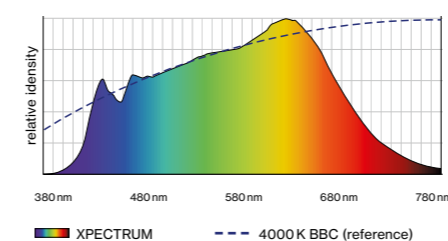

## Commercially available LED 4000 K

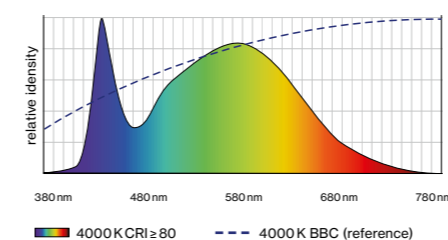

## Full-spectrum LED

EN XAL's new XPECTRUM LEDs deliver healthy, biologically effective light. The reduced blue light and increased cyan values reduce the blue light hazard for the eye to daylight-equivalent levels. The resulting non-visual, so-called melanopic light effect, improves concentration and increases sleep quality. The excellent colour rendering of IES TM 30-15  $R_i = 98$  and  $R_g = 101$  further helps visual comfort.

IT Il nuovo XPECTRUM LED di XAL assicura una luce sana con efficacia biologica. Lo spettro riduce le componenti azzurre e aumenta invece il ciano, con il risultato di una luce simile a quella diurna in cui i rischi per gli occhi dell'azzurro sono contenuti al minimo. Ne consegue un effetto non visivo, chiamato anche melanopico, che favorisce la concentrazione e migliora la qualità del sonno. Inoltre l'eccellente resa cromatica IES TM 30-15  $R_i = 98$  e  $R_g = 101$  migliora il comfort visivo.



## Optical accessories

EN Use a wide range of optical accessories to adapt spotlights for special applications. The optical light accessories can be attached or removed in one easy step and provide glare-free light at any point.

IT A disposizione tutta una serie di accessori ottici per adattare i faretto alle destinazioni specifiche. Sono accessori che si montano e smontano con un semplice gesto e che assicurano ovunque una luce priva di abbagliamento.

## Control options

EN MOVE IT Insets are available with DALI-2 and can be controlled individually. Configuration and control are simply done via DALI. As the open DALI communication standard is fully supported, all compatible luminaires can be easily integrated into the system. The Wireless-to-DALI Inset enables wireless control of DALI luminaire systems by using a communication module.

IT Gli inserti MOVE IT sono disponibili in variante DALI-2 per il controllo individuale. In questo caso la configurazione e il comando avvengono via DALI. Dal momento che viene assistito pienamente lo standard aperto di comunicazione DALI, è possibile integrare senza problemi qualsiasi apparecchio compatibile. L'elemento Wireless to DALI permette di controllare il sistema d'illuminazione senza bisogno di cavi, utilizzando un modulo di comunicazione.

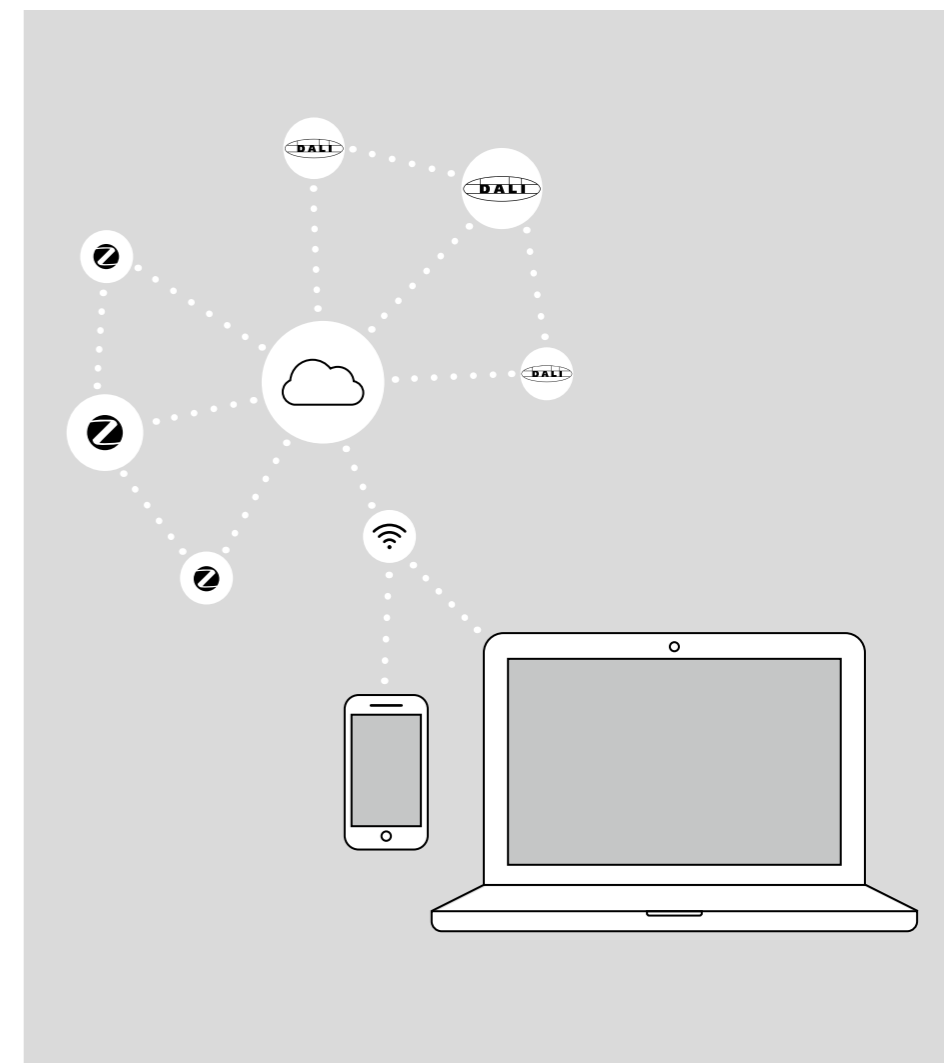

## Magnetic attachment

EN MOVE IT Insets are mounted without tools and magnetically fixed within the profile. They can, therefore, be adjusted and adapted according to the lighting requirements with just one movement.

IT Gli inserti luminosi MOVE IT si fissano all'interno dei profili con un sistema magnetico, senza bisogno di attrezzatura. Pertanto, basta un semplice gesto per spostarle e adattare alle esigenze dell'illuminazione.

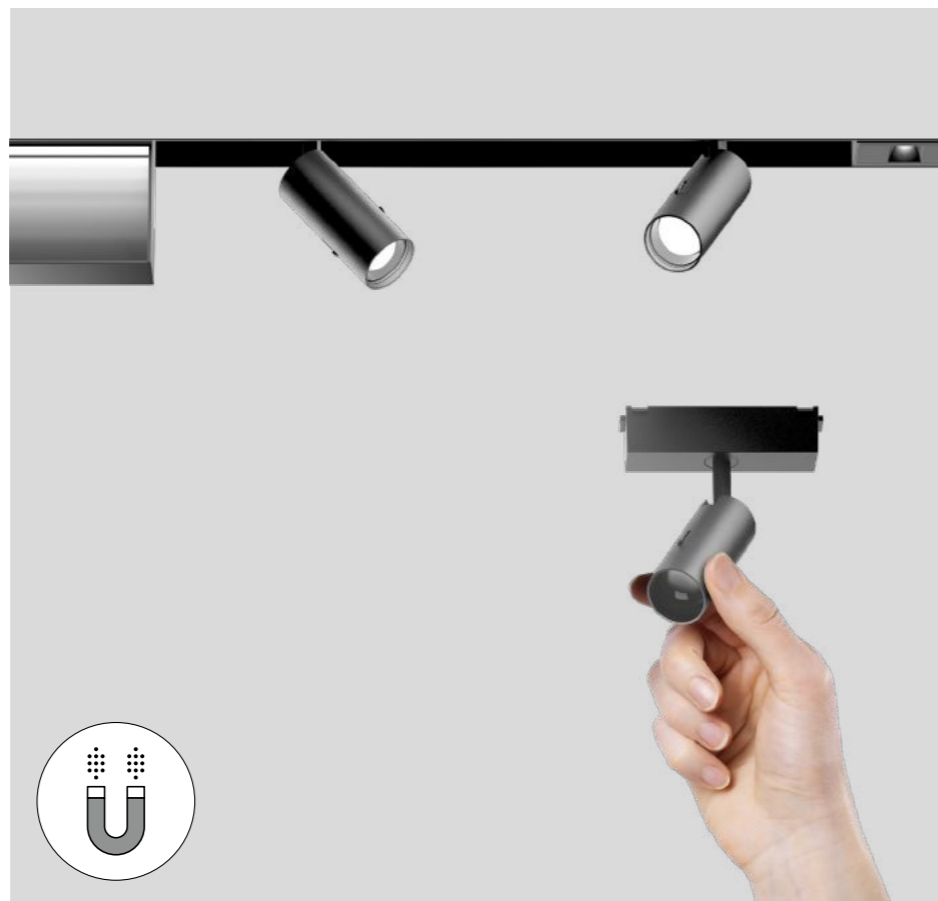

## IoT ready

EN IoT ready refers to the possibility of equipping luminaires with smart sensor technology. You receive valuable information, such as your lighting system's energy consumption or your rooms' utilisation over the day. You can set shut-off delay times and brightness values or plan time-controlled light sequences. The sensor is magnetically inserted into the track system like a spotlight and can be individually configured without restriction by existing standards.

IT IoT ready descrive la possibilità di equipaggiare gli apparecchi d'illuminazione con sensori smart. In questo modo otterrete informazioni preziose, come ad esempio il consumo energetico dell'impianto oppure il grado di utilizzo dei vostri spazi nell'arco della giornata. Inoltre potete programmare tempi di reazione e livelli di luminosità, oppure definire sequenze su base oraria. I sensori si montano nei binari elettrificati con un fissaggio magnetico, esattamente come i faretto, e si configurano in modo individuale senza limiti legati agli standard in uso.

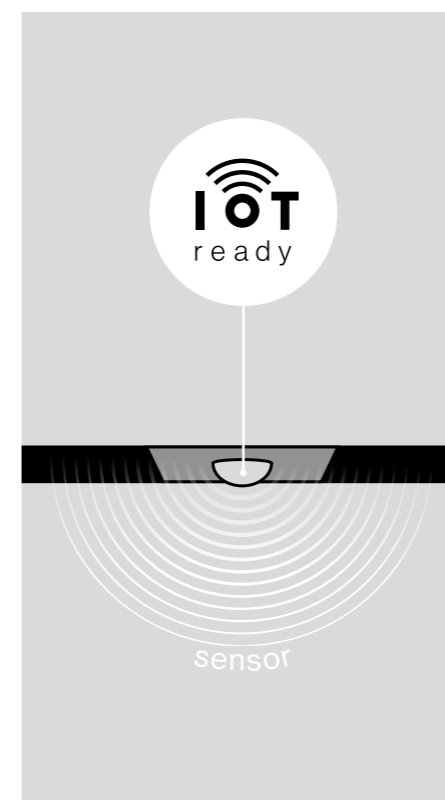

← back



## MOVE IT 25 S system

trimless / surface / suspended

Thin extruded aluminium profile with 31mm height and 28mm width groove; optionally for trimless installation in plasterboard ceilings (wall or ceiling mounting) with 12.5mm ceiling thickness; or for wall-/ceiling surface mounting or suspended mounting (cable suspension, height adjustment without tools, incl. black feed); optional with indirect light component for additional accentuation of the ceiling; for lighting systems; linear, 90° angle connectors or 90° CURVE segment; with integrated power track profile for take off of supply voltage and DALI signal; surface anodised or powder coated; insets can be installed flexibly and without tools by means of magnetic holders + locking

Profilo piatto in alluminio estruso con altezza di 31mm e larghezza giunti da 28mm; a scelta per incasso a scomparsa in controsoffitti in cartongesso (montaggio a parete o a soffitto) con spessore soffitto di 12,5mm; o per montaggio a parete/soffitto o montaggio a sospensione (cavo di sospensione, regolazione in altezza senza attrezzi, cavo di alimentazione nero incluso); in opzione con aggiunta di luce indiretta per accenti sul soffitto; per sistemi di illuminazione; lineare, giunto angolare a 90° o elemento CURVE a 90°; con binario elettrificato integrato per la riduzione della tensione di alimentazione e segnale DALI; superficie anodizzata o verniciatura a polvere; installazione flessibile e senza attrezzi degli inserti tramite supporto + attacco magnetico

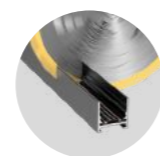

custom cut on building site

### Quickinfo

3000K  
CRI ≥ 90, 2 SDCM  
up to 117lm/W  
L80 @ 50000h  
non DIM, DALI-2

### Types

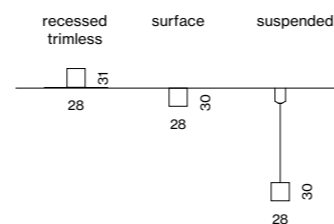

### connector

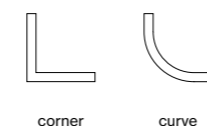

### Colours



### Order options

CONTROL	
non DIM	1
DALI-2	3

### MATERIAL COLOUR

● jet black RAL 9005

### Options on request

#### CONNECTOR

T-connector  
X-connector

#### INSTALLATION TRACK

acoustic soft ceilings

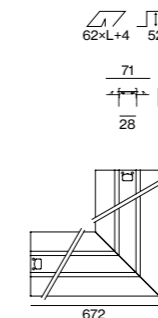

### MOVE IT 25 S trimless



#### INSTALLATION TRACK

L (mm)		ORDER CODE
617	channel	050-72120
1217	channel	050-72140
2417	channel	050-72180
3622	channel	050-72190
cust. cut	channel (non DIM)	E83131
cust. cut	channel (DALI-2)	E83141
672x645	channel corner* 90°	050-72110
661x661	channel corner* ceiling to wall 90°	050-72111

\*incl. electrical connector set

### Accessories

#### END CAPS

TYPE	ORDER CODE
end caps (pair)	050-7210008

#### BLIND COVER

L (mm)	ORDER CODE
1217	050-7004008
2417	050-7008008
3622	050-7009008
custom cut	E83000

blind cover can be shortened as desired

#### CONNECTOR SET

TYPE	ORDER CODE
linear connector (non DIM, DALI-2)	050-2031130
linear connector flexible	050-20321
mechanical linear connector (pair)	050-2011110

#### POWER FEEDER UNIT

TYPE	ORDER CODE
non DIM 2 × 2,5mm <sup>2</sup>	050-2020110
DALI-2 2 × 2,5 + 2 × 0,5mm <sup>2</sup>	050-2020130

cable length 500mm

### Electrical accessories

see page 708

← back

**Order options**

**CONTROL**

non DIM	1
DALI-2	3

**MATERIAL COLOUR**

● jet black RAL 9005	8
● traffic white 9016 / jet black 9005 P	
● gold dust 260-M / jet black 9005 G	
● special colours* p.992 X	

\*inside always in black

**MATERIAL COLOUR ACCESSORIES**

○ traffic white RAL 9016	7
● jet black RAL 9005	8

**MATERIAL COLOUR CABLE SUSPENSION**

chrome	0
black	8

**Options on request**

**CONNECTOR**

T-connector	
X-connector	



**MOVE IT 25 S surface/suspended**

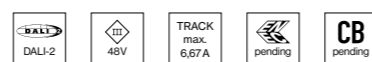

**INSTALLATION TRACK / BLIND COVER**

L (mm)		ORDER CODE
620	channel	050-73120
1220	channel	050-73140
2420	channel	050-73180
3625	channel	050-73190
cust. cut	channel (non DIM)	E83151
cust. cut	channel (DALI-2)	E83161
637x610	channel corner* 90°	050-73110
666x666	channel corner* ceiling to wall 90°	050-73111

\*incl. electrical connector set

1217	blind cover	050-7004008
2417	blind cover	050-7008008
3622	blind cover	050-7009008
cust. cut	blind cover	E83000

**CURVE CONNECTOR**

TYPE	ORDER CODE
mechanical & electrical R 300 mm	050-731303
mechanical R 300 mm	050-731311

**Accessories**

**END CAPS**

TYPE	ORDER CODE
end caps (pair)	050-731000

**CONNECTOR SET**

TYPE	ORDER CODE
mechanical linear conn. incl. 1500mm cable susp.	050-201131
mechanical linear connector surface	050-2011210
mechanical & electrical linear connector	050-2031230
mechanical & electrical corner connector flex	050-2032238

**POWER FEEDER UNIT**

TYPE	ORDER CODE
non DIM 2x2,5mm <sup>2</sup>	050-2022110
DALI-2 2x2,5 + 2x0,5mm <sup>2</sup>	050-2022130

cable length 2000 mm

**CEILING FASTENER / CABLE SUSPENSION / CANOPY**

TYPE	L (mm)	ORDER CODE
ceiling fastener	10	050-204111
cable suspension	1500	005-215211
canopy		005-231121

\*use every 1200 mm

**Electrical accessories**

see page 708

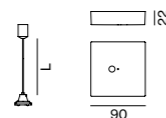
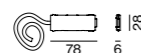
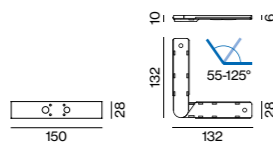
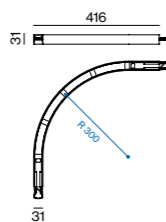
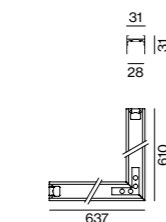

**Order options**

**COLOUR TEMPERATURE**

3000K	
-------	--

**CONTROL**

non DIM	1
DALI-2	3

**MATERIAL COLOUR**

● jet black RAL 9005	8
● traffic white 9016 / jet black 9005 P	
● gold dust 260-M / jet black 9005 G	
● special colours* p.992 X	

\*inside always in black

**MATERIAL COLOUR ACCESSORIES**

○ traffic white RAL 9016	7
● jet black RAL 9005	8

**MATERIAL COLOUR CABLE SUSPENSION**

chrome	0
black	8

**Options on request**

**COLOUR RENDERING INDEX**

CRI ≥ 98 XPECTRUM	
-------------------	--

**COLOUR TEMPERATURE**

2700K	
4000K	
tunable white 2700-6500K*	

\*DALI-2 DT8

**CONNECTOR**

T-connector	
X-connector	



**MOVE IT 25 S suspended indirect**



**INSTALLATION TRACK INDIRECT**

L (mm)	SYSTEM POWER	LUMINOUS FLUX	ORDER CODE
620	6.2W	638lm	050-74125
1220	15W	1790lm	050-74145
2420	33W	3830lm	050-74185
3625	50W	5745lm	050-74195
637x610	13W	1530lm	050-74110

corner\*

no custom cut on building side; \*incl. electrical connector set

1217	blind cover	050-7004008
2417	blind cover	050-7008008
3622	blind cover	050-7009008
cust. cut	blind cover	E83000

**Accessories**

**END CAPS**

TYPE	ORDER CODE
end caps (pair)	050-731000

**CONNECTOR SET**

TYPE	ORDER CODE
mechanical linear conn. incl. 1500mm cable susp.	050-201131
mechanical & electrical linear connector	050-2031230
mechanical & electrical corner connector flex	050-2032238

**POWER FEEDER UNIT**

TYPE	ORDER CODE
non DIM 2x2,5mm <sup>2</sup>	050-2022110
DALI-2 2x2,5 + 2x0,5mm <sup>2</sup>	050-2022130

cable length 2000 mm

**CABLE SUSPENSION / CANOPY**

TYPE	L (mm)	ORDER CODE
cable suspension	1500	005-215211
canopy		005-231121

\*use every 1200 mm

**Electrical accessories**

see page 708

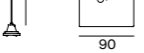
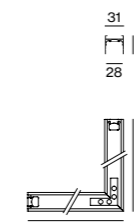

back



## MOVE IT 25 system

trimless / surface / suspended

Extruded aluminium profile with 28mm width groove; for trimless installation in plasterboard ceilings (wall or ceiling mounting) with 12.5mm ceiling thickness; or for wall-/ceiling surface mounting or suspended mounting (cable suspension, height adjustment without tools, incl. black feed); optional indirect light component for additional accentuation of the ceiling; for lighting systems; linear, 90° angle connectors or 90° CURVE segment; node connectors, up to 6 profile connection options; with power track profile for take off of supply voltage and DALI signal; surf. anod. or powder coated; insets can be installed flexibly and without tools by means of magnetic holders + locking; sound absorbing accessories available

Profilo di alluminio estruso con fuga larga 28mm; per mont. senza cornice in soffitti di cartongesso (a parete o a soffitto) con spessore 12,5mm; o per montaggio a parete/soffitto o montaggio a sospensione (cavo di sospensione, regolazione in altezza senza attrezzi, cavo di alimentazione nero incluso); in opzione aggiunta di luce indiretta per accenti sul soffitto; per sistemi di illuminazione; lineare, giunto angolare a 90° o elemento CURVE a 90°; connettori NODE, un massimo di 6 possibili modalità di attacco del profilo; con binario elettrificato per la riduzione della tensione di alimentazione e segnale DALI; sup. anod. o verniciata a polvere; installazione flessibile e senza attrezzi degli inserti tramite supporto + attacco magnetico; disponibile accessorio fonoassorbente

### Quickinfo

3000K  
CRI ≥ 90, 2 SDCM  
up to 117lm/W  
L80 @ 50 000h  
non DIM, DALI-2

### Types

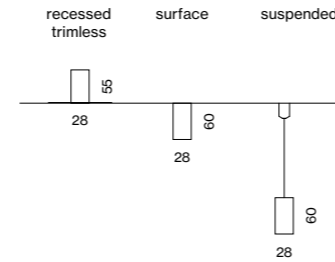

### connectors

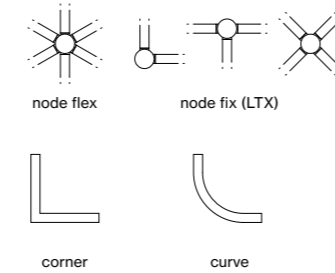

### Colours



### Order options

CONTROL	
non DIM	1
DALI-2	3

### MATERIAL COLOUR

● jet black RAL 9005

### Options on request

#### CONNECTOR

T-connector  
X-connector

#### INSTALLATION TRACK

acoustic soft ceilings

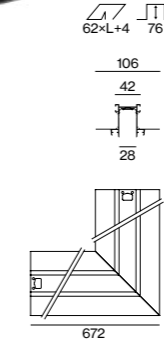

### MOVE IT 25 trimless



#### INSTALLATION TRACK

L (mm)		ORDER CODE
617	channel	050-72020
1217	channel	050-72040
2417	channel	050-72080
3622	channel	050-72090
cust. cut	channel (non DIM)	E83031
cust. cut	channel (DALI-2)	E83041
672x645	channel corner* 90°	050-72010
661x661	channel corner* ceiling to wall 90°	050-72011

\*incl. electrical connector set

### Accessories

#### END CAPS

TYPE	ORDER CODE
end caps (pair)	050-7200008

#### BLIND COVER

L (mm)	ORDER CODE
1217	050-7004008
2417	050-7008008
3622	050-7009008
custom cut	E83000

blind cover can be shortened as desired

#### CONNECTOR SET

TYPE	ORDER CODE
linear connector (non DIM, DALI-2)	050-2031130
linear connector flexible	050-20321
mechanical linear connector (pair)	050-2011110

#### POWER FEEDER UNIT

TYPE	ORDER CODE
non DIM 2 × 2,5mm <sup>2</sup>	050-2020110
DALI-2 2 × 2,5 + 2 × 0,5mm <sup>2</sup>	050-2020130

cable length 500mm

### Electrical accessories

see page 708

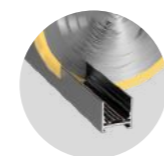

custom cut on building site



acoustic elements (p. 772)



← back

**Order options**

<b>CONTROL</b>	
non DIM	1
DALI-2	3

**MATERIAL COLOUR  
INSTALLATION TRACK**

● jet black RAL 9005	8
● traffic white 9016 / jet black 9005 P	
● gold dust 260-M / jet black 9005 G	
● special colours* p.992 X	

\*inside always in black

**MATERIAL COLOUR  
NODE CONNECTOR**

○ traffic white RAL 9016	7
● jet black RAL 9005	8
● special colours p.992 X	

**MATERIAL COLOUR  
NODE LTX / END CAP**

● jet black RAL 9005	8
● traffic white 9016 / jet black 9005 P	
● special colours p.992 X	

**MATERIAL COLOUR  
ACCESSORIES**

○ traffic white RAL 9016	7
● jet black RAL 9005	8

**MATERIAL COLOUR  
CABLE SUSPENSION**

chrome	0
black	8

**NODE CONNECTOR  
MOUNTING TYPE**

surface*	1
1500 mm cable susp. chrome	3
1500 mm cable susp. black	4

\*only for L/T/X

**Electrical accessories**

see page 708

**Acoustic elements**

see page 772



**MOVE IT 25 surface/suspended**

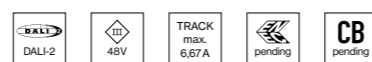

**INSTALLATION TRACK / BLIND COVER**

L (mm)		ORDER CODE
620	channel	050-73020
1220	channel	050-73040
2420	channel	050-73080
3625	channel	050-73090
cust. cut	channel (non DIM)	E83051
cust. cut	channel (DALI-2)	E83061
637x610	channel corner* 90°	050-73010
666x666	channel corner* ceiling to wall 90°	050-73011

\*incl. electrical connector set

1217	blind cover	050-7004008
2417	blind cover	050-7008008
3622	blind cover	050-7009008
cust. cut	blind cover	E83000

**CURVE CONNECTOR**

TYPE	ORDER CODE
mechanical & electrical R 300 mm	050-730303
mechanical R 300 mm	050-730311

**Accessories**

TYPE	ORDER CODE
end caps (pair)	050-730000

**FLEX NODE CONNECTOR**

TYPE	ORDER CODE
FLEX NODE surface mounted	050-203333
FLEX NODE surface mounted incl. feeder	050-202243
FLEX NODE cable suspension 1500 mm	050-20331
FLEX NODE cable susp. 1500 mm incl. feeder	050-20222
NODE end cap* incl. electrical connector	050-730010

\*order for every node connection (channel to node) 1 end cap

**FIX NODE CONNECTOR**

TYPE	ORDER CODE
L NODE incl. end cap & electrical connector	050-73054
T NODE incl. end cap & electrical connector	050-73052
X NODE incl. end cap & electrical connector	050-73053

**CONNECTOR SET**

TYPE	ORDER CODE
mechanical linear conn. incl. 1500 mm cable susp.	050-201131
mechanical linear connector surface	050-2011210
mechanical & electrical linear connector	050-2031230
mechanical & electrical corner connector flex	050-2032238

**POWER FEEDER UNIT**

TYPE	ORDER CODE
non DIM 2×2,5 mm <sup>2</sup>	050-2022110
DALI-2 2×2,5 + 2×0,5 mm <sup>2</sup>	050-2022130

cable length 2000 mm

**CEILING FASTENER / CABLE SUSPENSION / CANOPY**

TYPE	L (mm)	ORDER CODE
ceiling fastener	10	050-204111
cable susp. (use every 1200 mm)	1500	005-215211
canopy		005-231121

**Order options**

**COLOUR TEMPERATURE**

3000K

**CONTROL**

non DIM	1
DALI-2	3

**MATERIAL COLOUR  
INSTALLATION TRACK**

● jet black RAL 9005	8
● traffic white 9016 / jet black 9005 P	
● gold dust 260-M / jet black 9005 G	
● special colours* p.992 X	

\*inside always in black

**MATERIAL COLOUR  
NODE CONNECTOR**

○ traffic white RAL 9016	7
● jet black RAL 9005	8
● special colours p.992 X	

**MATERIAL COLOUR  
NODE LTX / END CAP**

● jet black RAL 9005	8
● traffic white 9016 / jet black 9005 P	
● special colours p.992 X	

**MATERIAL COLOUR  
ACCESSORIES**

○ traffic white RAL 9016	7
● jet black RAL 9005	8

**MATERIAL COLOUR  
CABLE SUSPENSION**

chrome	0
black	8

**NODE CONNECTOR  
MOUNTING TYPE**

surface*	1
1500 mm cable susp. chrome	3
1500 mm cable susp. black	4

\*only for L/T/X

**Options on request**

**COLOUR RENDERING INDEX**

CRI ≥ 98 XPECTRUM

**COLOUR TEMPERATURE**

2700K
4000K
tunable white 2700–6500 K*

\*DALI-2 DT8

**LUMINOUS FLUX** value calculated for 3000K, CRI ≥ 90, colour white/black



**MOVE IT 25 suspended indirect**



**INSTALLATION TRACK INDIRECT**

L (mm)	SYSTEM POWER	LUMINOUS FLUX	ORDER CODE
620	6.2 W	638 lm	050-74025
1220	15 W	1790 lm	050-74045
2420	33 W	3830 lm	050-74085
3625	50 W	5745 lm	050-74095
637x610	13 W	1530 lm	050-74010

\*incl. electrical connector set

1217	blind cover	050-7004008
2417	blind cover	050-7008008
3622	blind cover	050-7009008
cust. cut	blind cover	E83000

**Accessories**

TYPE	ORDER CODE
end caps (pair)	050-730000

**FLEX NODE CONNECTOR**

TYPE	ORDER CODE
FLEX NODE cable suspension 1500 mm	050-20331
FLEX NODE cable susp. 1500 mm incl. feeder	050-20222
FLEX NODE end cap* incl. electrical connector	050-730010

\*order for every node connection (channel to node) 1 end cap

**FIX NODE CONNECTOR**

TYPE	ORDER CODE
L NODE incl. end cap & electrical connector	050-73054
T NODE incl. end cap & electrical connector	050-73052
X NODE incl. end cap & electrical connector	050-73053

**CONNECTOR SET**

TYPE	ORDER CODE
mechanical linear conn. incl. 1500 mm cable susp.	050-201131
mechanical & electrical linear connector	050-2031230
mechanical & electrical corner connector flex	050-2032238

**POWER FEEDER UNIT**

TYPE	ORDER CODE
non DIM 2×2,5 mm <sup>2</sup>	050-2022110
DALI-2 2×2,5 + 2×0,5 mm <sup>2</sup>	050-2022130

cable length 2000 mm

**CABLE SUSPENSION / CANOPY**

TYPE	L (mm)	ORDER CODE
cable suspension*	1500	005-215211
canopy		005-231121

\*use every 1200 mm

**Electrical accessories**

see page 708

**Acoustic elements**

see page 772

← back

**Order options**

**CONTROL** ▾

non DIM	1
DALI-2	3

**MATERIAL COLOUR** ▣

○ traffic white RAL 9016	7
● jet black RAL 9005	8

**Electrical accessories**

**POWER SUPPLY INTRACK** supply 220-240 V AC, 48 V, 50-60 Hz

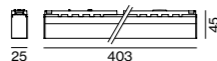

TYPE	EFFICIENCY	MOUNTING	L-W-H (mm)	ORDER CODE
100W <input type="checkbox"/> PC II $\eta$ 92%		intrack	403-26-46	050-2071038
150W <input type="checkbox"/> PC II $\eta$ 92%		intrack	403-26-46	050-2071138

ENEC approved, incl. feeder cable 2000mm; DALI-2 SELV device integrated

**POWER SUPPLY SURFACE** supply 220-240 V AC, 48 V, 50-60 Hz

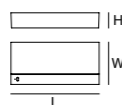

TYPE	EFFICIENCY	MOUNTING	L-W-H (mm)	ORDER CODE
60W <input type="checkbox"/> PC II $\eta$ 88%		surface	305-144-54	050-20551
100W <input type="checkbox"/> PC II $\eta$ 92%		surface	455-104-40	050-20554
150W <input type="checkbox"/> PC II $\eta$ 92%		surface	455-104-40	050-20552
250W <input type="checkbox"/> PC II $\eta$ 93%		surface	455-104-40	050-20555
320W <input type="checkbox"/> PC I $\eta$ 94%		surface	305-144-54	050-20553

ENEC approved, incl. feeder cable 2000mm; DALI-2 SELV device integrated

**POWER SUPPLY EXTERNAL** supply 220-240 V AC, 48 V, 50-60 Hz

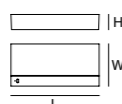

TYPE	EFFICIENCY	MOUNTING	L-W-H (mm)	ORDER CODE
60W <input type="checkbox"/> PC II $\eta$ 88%		external	163-43-32	002-62133
100W <input type="checkbox"/> PC II $\eta$ 92%		external	350-30-18	002-62134
150W <input type="checkbox"/> PC II $\eta$ 92%		external	350-30-18	002-62135
250W <input type="checkbox"/> PC II $\eta$ 93%		external	400-40-22	002-62139
320W <input type="checkbox"/> PC I $\eta$ 94%		external	252-90-44	002-60320

ENEC approved, incl. feeder cable 2000mm

**DIN RAIL POWER SUPPLY BASIC 48 V**

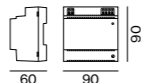

220-240 V | 50-60 Hz |  PC II | MTBF @ 55° ambient temperature

TYPE	EFFICIENCY / MTBF	W-H-D (mm)	ORDER CODE
96W $\eta$ 89% / > 300.000h		90-90-60	005-6520010

**DIN RAIL POWER SUPPLY PRO 48 V**

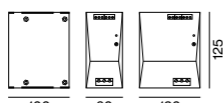

220-240 V | 50-60 Hz |  PC I | MTBF @ 55° ambient temperature  
cascadable max. 5 devices (240 W) or 3 devices (480 W)

TYPE	EFFICIENCY / MTBF	W-H-D (mm)	ORDER CODE
240W $\eta$ 92% / > 400.000h		60-125-100	005-6220110
480W $\eta$ 93% / > 350.000h		120-125-100	005-6220210

**DALI-2 SELV DEVICE**

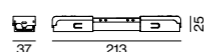

TYPE	L-W-H (mm)	ORDER CODE
control unit	213-37-25	050-2061130

necessary to create DALI-2 SELV signal; DALI power supply integrated

**DALI SENSOR**



TYPE	L-W-H (mm)	ORDER CODE
ESSENTIAL sensor (brightness & presence)	125-28-45	050-2063178

**WIRELESS TO DALI-2 CONTROL DEVICE**



TYPE	L-W-H (mm)	ORDER CODE
Zigbee 3.0	111-25-45	050-2065130
Casambi	111-25-45	050-2065230

DALI-2 SELV device required

**WIRELESS TO DALI-2 REPEATER**



TYPE	L-W-H (mm)	ORDER CODE
Zigbee 3.0	111-25-45	050-2066130
Casambi	111-25-45	050-2066230

**MIDDLE FEED**

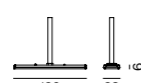

TYPE	ORDER CODE
non DIM 2x2,5mm <sup>2</sup>	050-2038110
DALI-2 2x2,5 + 2x0,5mm <sup>2</sup>	050-2038130

cable length 2000mm

**Blique by Nobis**  
Stockholm, SE –  
by Wingårdhs

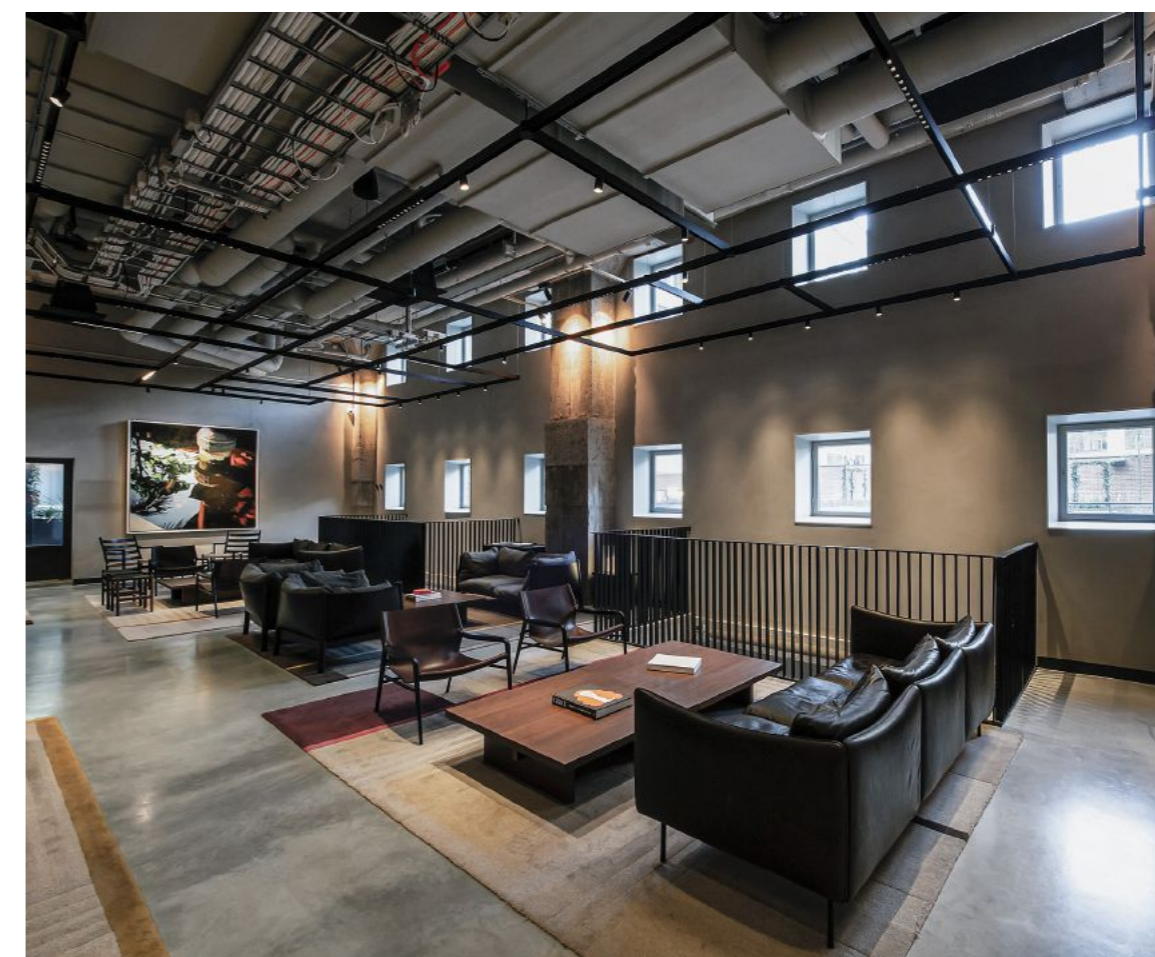
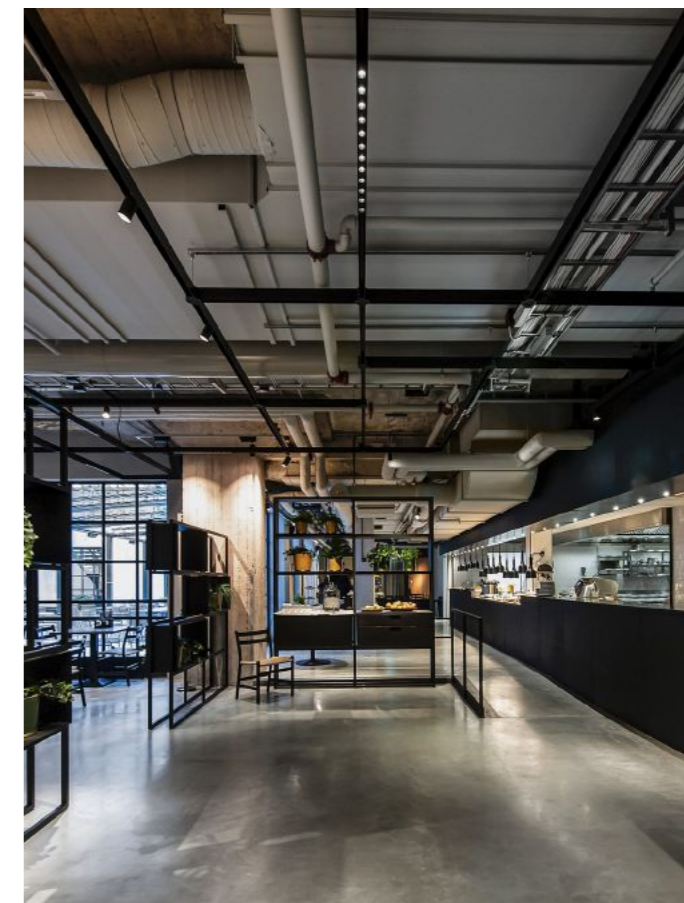

← back



**JUST**  
spotlight inset 25/25 S

**Quickinfo**

2700K, 3000K, 4000K, TW, CWD  
CRI ≥ 90, 2 SDCM  
non DIM, DALI-2

L95 @ 50 000h  
JUST 32 focus up to 47lm/W

L80 @ 50 000h  
JUST 45 up to 72lm/W

L90 @ 50 000h  
JUST 55 up to 75lm/W

**Types**

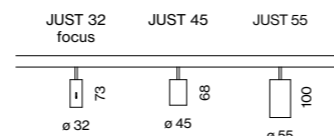

**Colours**



**Light distributions**

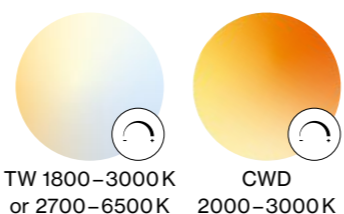
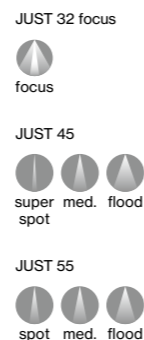

**Order options**

**COLOUR TEMPERATURE**

2700K	4
3000K	5
4000K	6
colour warm dim. 2000-3000K*	
tunable white 1800-3000K**	
tunable white 2700-6500K**	

\*DALI-2 \*\*DALI-2 DT8

**CONTROL**

non DIM	1
DALI-2	3

**MATERIAL COLOUR**

○ traffic white RAL 9016	7
● jet black RAL 9005	8
● special colours p. 992	X

**BEAM ANGLE JUST 45**

medium 23°	M
flood 44°	F

**BEAM ANGLE JUST 55**

spot 16°	S
medium 28°	M
flood 37°	F

**Options on request**

**OPTICAL ACCESSORIES**  
elliptical sculpture foil  
snoot  
colour filter (red, blue, green, etc.)  
only for JUST 32 focus

**INSET POWER** in watts is the current consumption excluding any ballast  
**LUMINOUS FLUX** value calculated for 3000K, CRI ≥ 90, colour white, lens flood  
2700K -5%, 4000K +5%

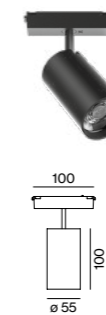
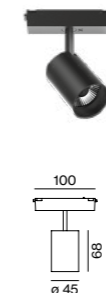
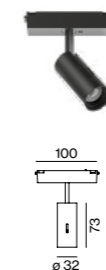

**JUST 32 focus 17-43°**



**SPOTLIGHT**

INSET POWER	LUMINOUS FLUX	ORDER CODE
8.3W	393lm	050-01111

**JUST 45**



**SPOTLIGHT**

INSET POWER	LUMINOUS FLUX	ORDER CODE
6.1W super spot 8°	297lm	050-01313
11W	788lm	050-01311
12W CWD 2000-3000K	430lm	050-0131E3
11W TW 1800-3000K	555lm	050-0131L3
11W TW 2700-6500K	683lm	050-0131D3

**JUST 55**



**SPOTLIGHT**

INSET POWER	LUMINOUS FLUX	ORDER CODE
15.9W	1300lm	050-01433
30W	2090lm	050-01423

**Optical accessories**

**HONEYCOMB LOUVER**

TYPE	Ø-H (mm)	ORDER CODE
JUST 32 focus	30·4	007-1965168
JUST 45	42·3	007-1965188
JUST 55	50·3	007-1965598



**Hotel & Restaurant Mühlthof**  
Neufelden, AT –  
by AllesWirdGut Architekten



**Private Residence** Århus, DK –  
by Friis Moltke Architects  
with lighting design by anker & co



**Petersen Tegl** Copenhagen, DK –  
by Annette Petersen & Peter Zinck  
with lighting design by anker & co



**Office of ENTASIS Architects**  
Copenhagen, DK –  
by Christian Cold including lighting  
design by Christian Cold / anker & co



← back



**Quickinfo**

2700 K, 3000 K, TW  
 CRI ≥ 90, 3 SDCM  
 up to 146 lm/W  
 L90 @ 50 000 h  
 non DIM, DALI-2

**Types**

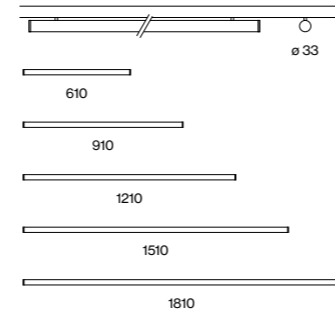

**Colour**



**Light distribution**



**Order options**

**COLOUR TEMPERATURE**

2700 K	4
3000 K	5
tunable white 1800–4000 K*	L

\*DALI-2 DT8

**CONTROL**

non DIM	1
DALI-2	3

**MATERIAL COLOUR**

● jet black RAL 9005
----------------------

**Options on request**

**COLOUR RENDERING INDEX**

CRI ≥ 98 XPECTRUM
-------------------

**COLOUR TEMPERATURE**

4000 K
--------

**MATERIAL COLOUR**

○ traffic white RAL 9016
--------------------------

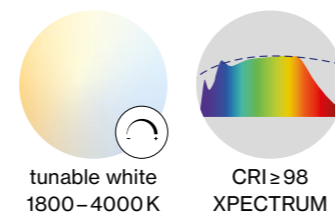

LUMINOUS FLUX value calculated for CRI ≥ 90, colour black

**LIGHT INSET 25 S**

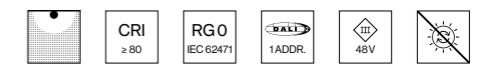
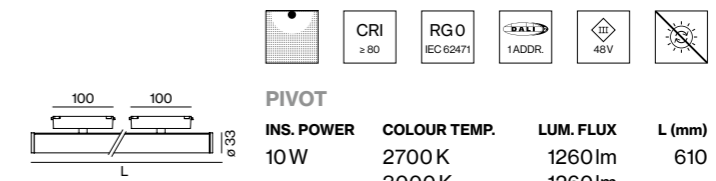

**PIVOT**

INS. POWER	COLOUR TEMP.	LUM. FLUX	L (mm)	ORDER CODE
10 W	2700 K	1260 lm	610	0 5 0 - 1 3 1 2 :: 8 0
	3000 K	1260 lm		
13 W	2700 K	1900 lm	910	0 5 0 - 1 3 1 3 :: 8 0
	3000 K	1890 lm		
17 W	2700 K	2530 lm	1210	0 5 0 - 1 3 1 4 :: 8 0
	3000 K	2530 lm		
22 W	2700 K	3160 lm	1510	0 5 0 - 1 3 1 5 :: 8 0
	3000 K	3160 lm		
26 W	2700 K	3790 lm	1810	0 5 0 - 1 3 1 6 :: 8 0
	3000 K	3790 lm		

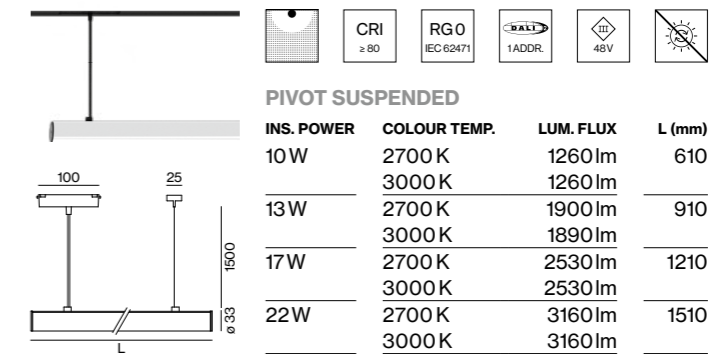

**PIVOT SUSPENDED**

INS. POWER	COLOUR TEMP.	LUM. FLUX	L (mm)	ORDER CODE
10 W	2700 K	1260 lm	610	0 5 0 - 0 3 2 2 :: 8 0
	3000 K	1260 lm		
13 W	2700 K	1900 lm	910	0 5 0 - 0 3 2 3 :: 8 0
	3000 K	1890 lm		
17 W	2700 K	2530 lm	1210	0 5 0 - 0 3 2 4 :: 8 0
	3000 K	2530 lm		
22 W	2700 K	3160 lm	1510	0 5 0 - 0 3 2 5 :: 8 0
	3000 K	3160 lm		

**LIGHT INSET 25**

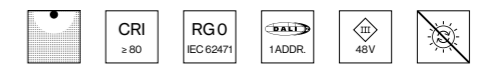
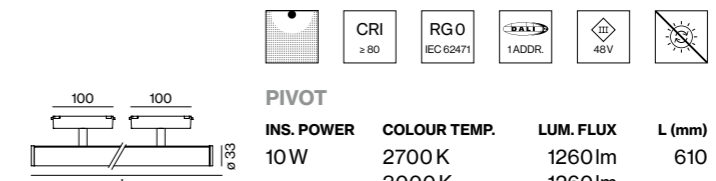

**PIVOT**

INS. POWER	COLOUR TEMP.	LUM. FLUX	L (mm)	ORDER CODE
10 W	2700 K	1260 lm	610	0 5 0 - 0 3 1 2 :: 8 0
	3000 K	1260 lm		
13 W	2700 K	1900 lm	910	0 5 0 - 0 3 1 3 :: 8 0
	3000 K	1890 lm		
17 W	2700 K	2530 lm	1210	0 5 0 - 0 3 1 4 :: 8 0
	3000 K	2530 lm		
22 W	2700 K	3160 lm	1510	0 5 0 - 0 3 1 5 :: 8 0
	3000 K	3160 lm		
26 W	2700 K	3790 lm	1810	0 5 0 - 0 3 1 6 :: 8 0
	3000 K	3790 lm		

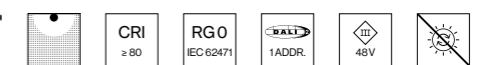
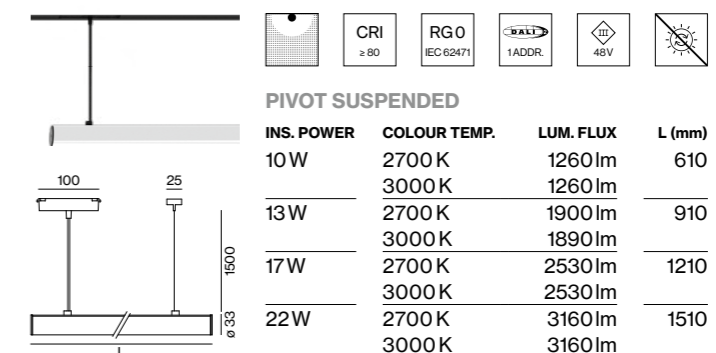

**PIVOT SUSPENDED**

INS. POWER	COLOUR TEMP.	LUM. FLUX	L (mm)	ORDER CODE
10 W	2700 K	1260 lm	610	0 5 0 - 0 3 2 2 :: 8 0
	3000 K	1260 lm		
13 W	2700 K	1900 lm	910	0 5 0 - 0 3 2 3 :: 8 0
	3000 K	1890 lm		
17 W	2700 K	2530 lm	1210	0 5 0 - 0 3 2 4 :: 8 0
	3000 K	2530 lm		
22 W	2700 K	3160 lm	1510	0 5 0 - 0 3 2 5 :: 8 0
	3000 K	3160 lm		



**PIVOT**  
 graphic light inset 25/25 S





**Autodesk** Krakow, PL –  
by The Design Group with  
lighting design by Plus Lighting





**Büroausbau in Soho**  
London, UK – by Design Haus  
Liberty / DHL with lighting design  
by Alkestie Skarlatou, lightinspace



**The Raum** Bolzano, IT –  
by bergundtal gmbh.



Design Fair Marbella, ES –  
by Welcome Design



**Quickinfo**

non DIM, DALI-2

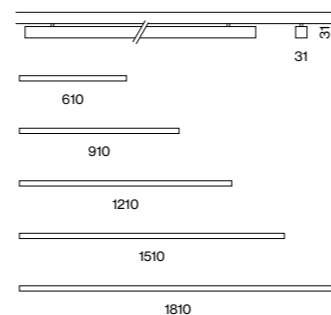
**Types****Colours****Order options**

CONTROL	
non DIM	1
DALI-2	3

**MATERIAL COLOUR**

● jet black RAL 9005	8
● traffic white 9016 / jet black 9005 P	
● gold dust 260-M / jet black 9005 G	
● special colours* ● p. 992	X

\*inside always in black

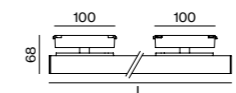
**MOVE IT 25 S****FLEXTRACK**

L (mm)	ORDER CODE
610	050-45120
910	050-45130
1210	050-45140
1510	050-45150
1810	050-45160

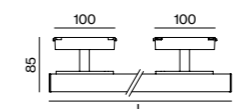
**MOVE IT 25****FLEXTRACK**

L (mm)	ORDER CODE
610	050-45020
910	050-45030
1210	050-45040
1510	050-45050
1810	050-45060

**FLEXTRACK**

system extension 25/25S

EN Thin extruded aluminium profile with 31mm height and 28mm width groove; with integrated power track profile for take off of supply voltage and DALI signal; surface anodised or powder coated; for installation in two MOVE IT 25 or 25 S profiles; profile can be installed and moved without tools by means of magnetic holders + locking; mount 360° rotatable and freely slidable on one end; light insets can be installed flexibly and without tools by means of magnetic holders+locking

IT Profilo piatto in alluminio estruso con altezza di 31mm e larghezza giunti da 28mm; con binario elettrificato integrato per la riduzione della tensione di alimentazione e segnale DALI; superficie anodizzata o verniciatura a polvere; per inserimento in due profili MOVE IT 25 o MOVE IT 25 S; profilo con installazione e posizionamento tramite supporto+attacco magnetico senza bisogno di attrezzi; supporto girevole 360° e posizionabile a un'estremità secondo le esigenze; installazione flessibile e senza attrezzi degli inserti luce tramite supporto+attacco magnetico

**Jewelery + Optical Store**  
Ludwigsburg, DE –  
by Ippolito Fleitz Group –  
Identity Architects



← back

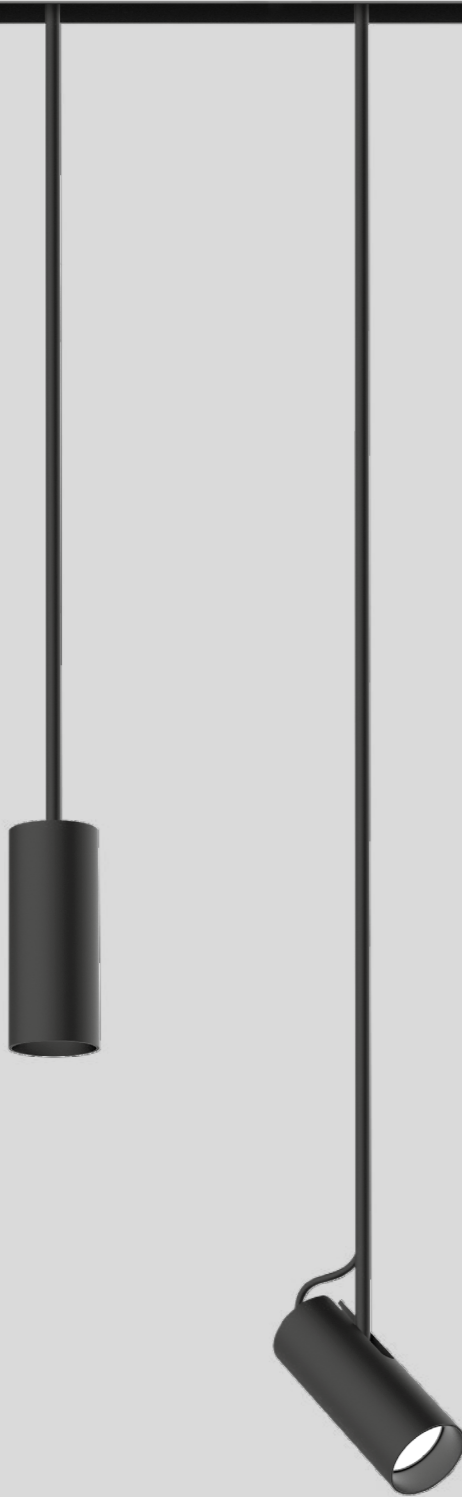

**Quickinfo**

2700 K, 3000 K, 4000 K, TW  
 CRI ≥ 90, 3 SDCM  
 up to 84 lm/W  
 L90 @ 50 000 h  
 non DIM, DALI-2

**Types**

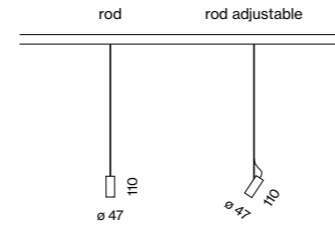

**Colours**

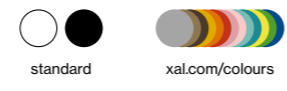

**Light distributions**



**Order options**

**CABLE SUSPENSION**

1500 mm	5
2000 mm with hook*	6

\*one ring included

**COLOUR TEMPERATURE**

2700 K	4
3000 K	5
4000 K	6
tunable white 2200–4000 K*	

\*DALI-2 DT8

**CONTROL**

non DIM	1
DALI-2	3

**MATERIAL COLOUR**

○ traffic white RAL 9016	7
● jet black RAL 9005	8
special colours  p.992	X

**ACCESSORY COLOUR**

○ traffic white RAL 9016	7
● jet black RAL 9005	8

**BEAM ANGLE**

medium 25°	M
flood 44°	F

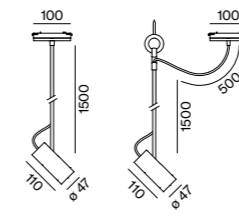
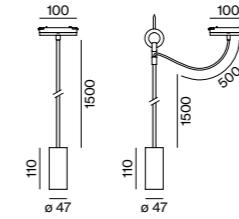

**ARY rod**



**DOWNLIGHT**

INSET POWER	COLOUR TEMP.	LUMINOUS FLUX	ORDER CODE
14 W	2700 K	1050 lm	0 5 0 - 0 3 2 1
	3000 K	1100 lm	
	4000 K	1180 lm	
5.4 W TW	2200–4000 K	284 lm	0 5 0 - 0 3 2 1 D 3

**ARY rod adjustable**



**SPOTLIGHT**

INSET POWER	COLOUR TEMP.	LUMINOUS FLUX	ORDER CODE
14 W	2700 K	1050 lm	0 5 0 - 0 3 3 1
	3000 K	1100 lm	
	4000 K	1180 lm	
5.4 W TW	2200–4000 K	284 lm	0 5 0 - 0 3 3 1 D 3

**Mounting accessories**

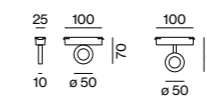

**RING track mounted**

TYPE	Ø-H (mm)	ORDER CODE
MOVE IT 25 S	50-70	0 5 0 - 1 5 1 0 1 1
MOVE IT 25	50-91	0 5 0 - 0 5 1 0 1 1



**RING ceiling mounted**

TYPE	Ø-H (mm)	ORDER CODE
MOVE IT 25S/25	50-88	0 5 0 - 0 5 1 0 2 1

reddot winner 2020

DESIGN AWARD 2020

**ARY rod**  
 decorative inset 25/25 S

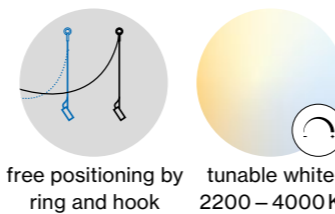

LUMINOUS FLUX value calculated for CRI ≥ 90, colour white, lens flood

← back



 red dot winner 2020

 DESIGN AWARD 2020

**ARY cable**  
decorative inset 25/25 S

**Quickinfo**

2700 K, 3000 K, 4000 K, TW  
CRI ≥ 90, 3 SDCM  
up to 84 lm/W  
L90 @ 50 000 h  
non DIM, DALI-2

**Types**

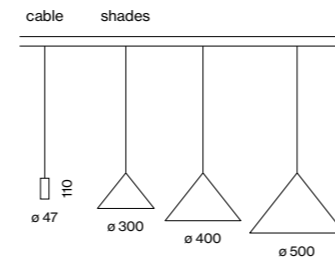

**Colours**

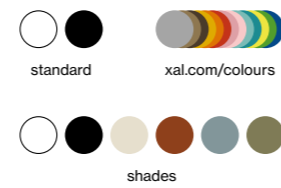

**Light distributions**

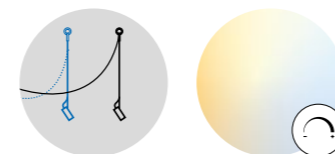

free positioning by ring and hook    tunable white 2200 – 4000 K

**Order options**

**CABLE SUSPENSION**

1500 mm	5
2000 mm with hook*	6

\*one ring included

**COLOUR TEMPERATURE**

2700 K	4
3000 K	5
4000 K	6
tunable white 2200–4000 K*	

\*DALI-2 DT8

**CONTROL**

non DIM	1
DALI-2	3

**MATERIAL COLOUR**

○ traffic white RAL 9016	7
● jet black RAL 9005	8
● special colours ☉ p. 992	X

**ACCESSORY COLOUR**

○ traffic white RAL 9016	7
● jet black RAL 9005	8

**BEAM ANGLE**

medium 25°	M
flood 44°	F

**SHADE COLOUR**

● velvet beige RAL 085 80 10	C
● madeira brown RAL 050 40 40	T
● kingfisher grey RAL 230 60 10	L
● woodpecker olive RAL 1050 20	G
○ signal white RAL 9003	W
● signal black RAL 9004	B

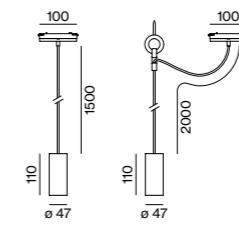

**ARY cable**



**DOWNLIGHT**

INSET POWER	COLOUR TEMP.	LUMINOUS FLUX	ORDER CODE
14 W	2700 K	1050 lm	0 5 0 - 0 5 1 1 1
	3000 K	1100 lm	
	4000 K	1180 lm	
5.4 W TW	2200–4000 K	284 lm	0 5 0 - 0 5 1 1 D 3

**Mounting accessories**

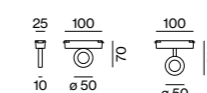

**RING track mounted**

TYPE	Ø-H (mm)	ORDER CODE
MOVE IT 25 S	50-70	0 5 0 - 1 5 1 0 1 1
MOVE IT 25	50-91	0 5 0 - 0 5 1 0 1 1



**RING ceiling mounted**

TYPE	Ø-H (mm)	ORDER CODE
MOVE IT 25S/25	50-88	0 5 0 - 0 5 1 0 2 1

**Optical accessories**

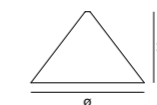

**SHADE**

TYPE	Ø-H (mm)	ORDER CODE
cone 300	300-188	0 4 9 - 5 9 3 3 1 1
cone 400	400-253	0 4 9 - 5 9 3 4 1 1
cone 500	500-318	0 4 9 - 5 9 3 5 1 1

only available for ARY cable

LUMINOUS FLUX value calculated for CRI ≥ 90, colour white, lens flood





**Noma 2.0**  
Copenhagen, DK –  
by BIG with interior design  
by Studio David Thulstrup



**Gwerder Fidel Energietechnik AG**  
Ibach, CH – by FORM  
Innenarchitektur GmbH



← back

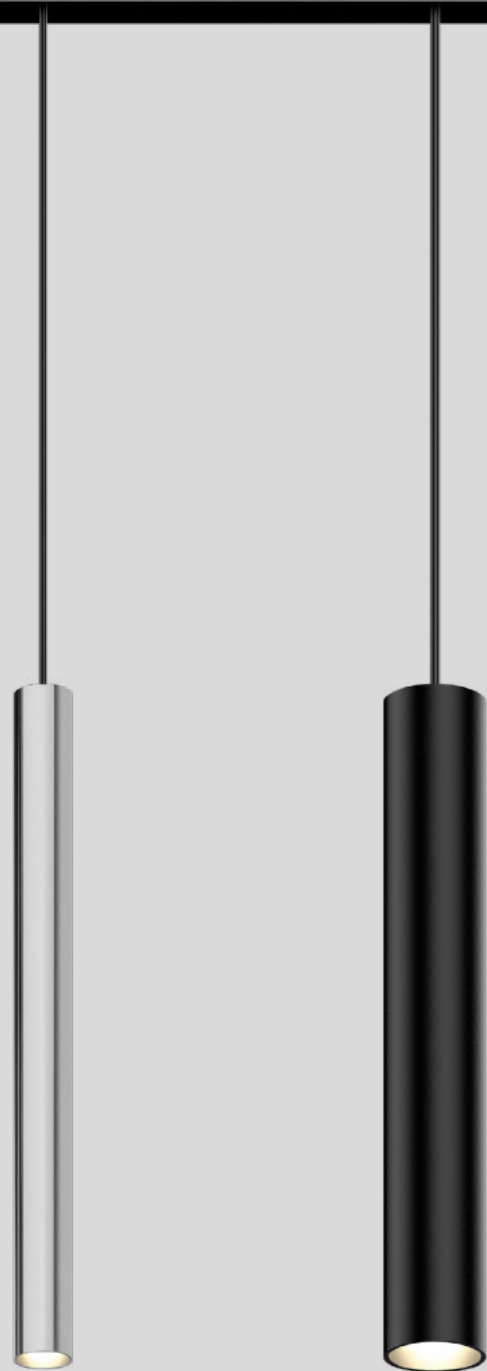

**Quickinfo**

2700K, 3000K, TW  
 CRI ≥ 90, 3 SDCM  
 up to 75 lm/W  
 L80 @ 50 000 h  
 non DIM, DALI-2

**Types**

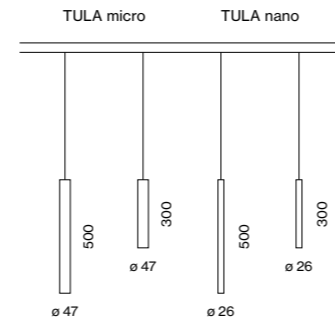

**Colours**



**Light distributions**



**Order options**

**HOUSING HEIGHT**

300 mm	0
500 mm	1

**CABLE SUSPENSION**

1500 mm	7
2000 mm with hook*	6

\*one ring included

**COLOUR TEMPERATURE**

2700K	4
3000K	5
tunable white 2200 – 4000K*	

\*DALI-2 DT8

**CONTROL**

non DIM	1
DALI-2	3

**MATERIAL COLOUR**

chrome	4
traffic white RAL 9016	7
jet black RAL 9005	8
special colours p. 992	X

**ACCESSORY COLOUR**

traffic white RAL 9016	7
jet black RAL 9005	8

**BEAM ANGLE**

medium 25°	M
flood 44°	F

**Options on request**

**COLOUR TEMPERATURE**

4000K	
-------	--

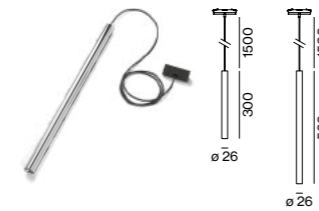

**TULA nano suspended**

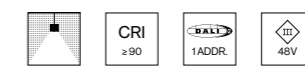

**DOWNLIGHT**

INSET POWER	COLOUR TEMP.	LUMINOUS FLUX	ORDER CODE
11W	2700K	642lm	050-L 8 1 1 :: ▣ ▣ ▲
	3000K	688lm	

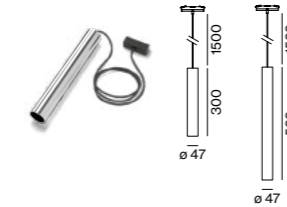

**TULA micro suspended**

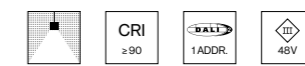

**DOWNLIGHT**

INSET POWER	COLOUR TEMP.	LUMINOUS FLUX	ORDER CODE
14W	2700K	998lm	050-L 8 1 5 :: ▣ ▣ ▲
	3000K	1048lm	
5.4W	2200 – 4000K	254lm	050-L 8 1 5 D 3 ▣ ▲

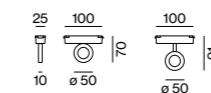

**Mounting accessories**

**RING track mounted**

TYPE	Ø-H (mm)	ORDER CODE
MOVE IT 25 S	50-70	050-151011 ▣
MOVE IT 25	50-91	050-051011 ▣



**RING ceiling mounted**

TYPE	Ø-H (mm)	ORDER CODE
MOVE IT 25S/25	50-88	050-051021 ▣

**TULA**  
 decorative inset 25/25S

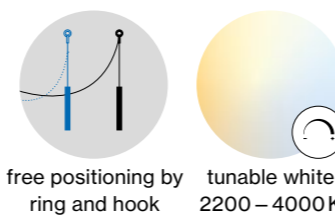

**LUMINOUS FLUX** value calculated for  
 CRI ≥ 90, colour white, lens flood

**Mape kitchen & interior** Putte, BE**Private Residence** Århus, DK –  
by Friis Moltke Architects with  
lighting design by anker & co



**Private Residence** Linz, AT –  
by ARKD, architekturbüro arkade  
zt gmbh including lighting design



back

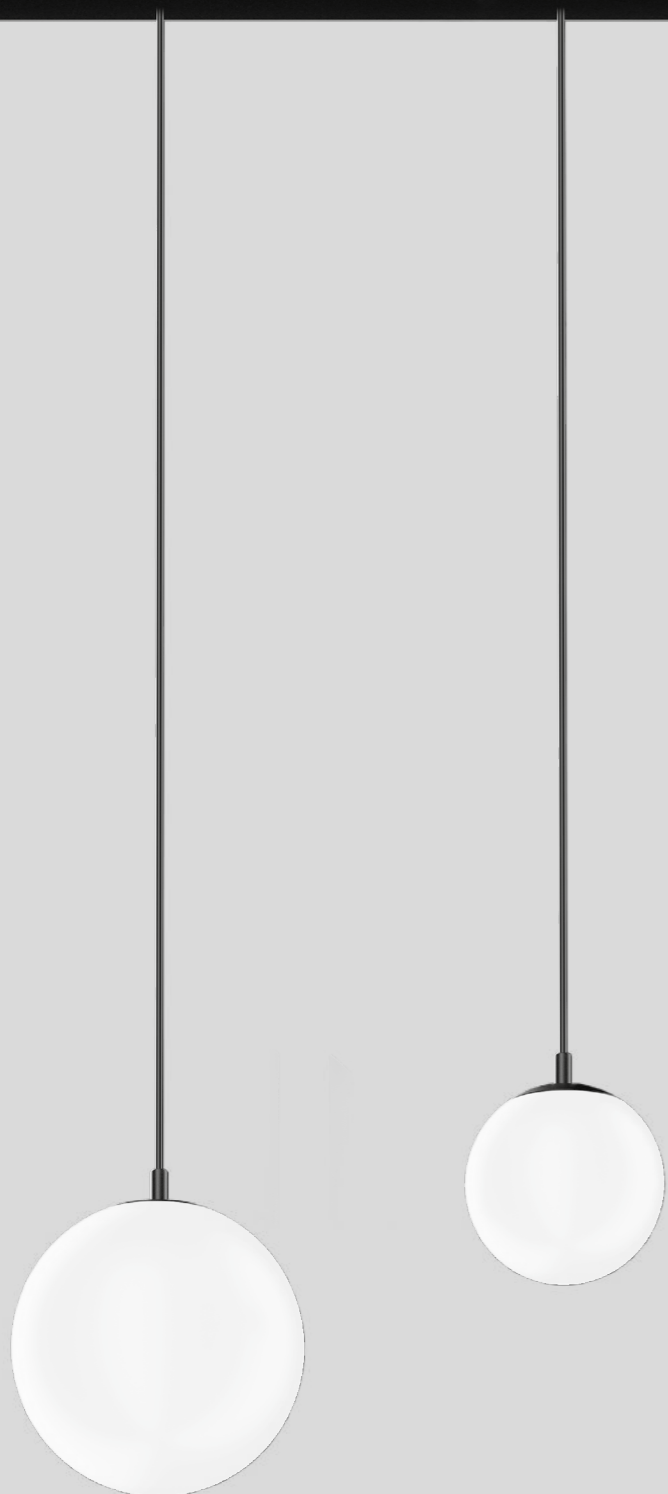

### Quickinfo

2700 K, 3000 K  
 CRI ≥ 90, 3 SDCM  
 up to 55 lm/W  
 L80 @ 50 000 h  
 non DIM, DALI-2  
 IP 40

### Types

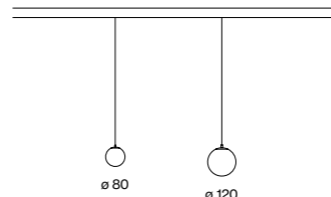

### Colours



### Light distribution



### Order options

CABLE SUSPENSION	
1500 mm	5
2000 mm with hook*	6

\*one ring included

COLOUR TEMPERATURE	
2700 K	4
3000 K	5

CONTROL	
non DIM	1
DALI-2	3

MATERIAL COLOUR	
○ pure white RAL 9010	7
● jet black RAL 9005	8
● special colours p. 992	X

ACCESSORY COLOUR	
○ pure white RAL 9010	7
● jet black RAL 9005	8

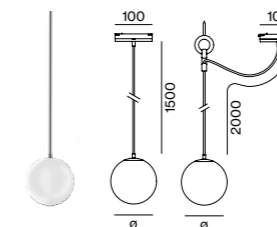

### PAL suspended



### DOWNLIGHT

INS. POWER	COLOUR TEMP.	LUM. FLUX	Ø (mm)	ORDER CODE
9.1W	2700 K	472lm	80	050-1 1 1 1
	3000 K	498lm		
9.1W	2700 K	472lm	120	050-1 1 3 1
	3000 K	498lm		

### Mounting accessories

#### RING track mounted

TYPE	Ø-H (mm)	ORDER CODE
MOVE IT 25 S	50-70	050-151011
MOVE IT 25	50-91	050-051011

#### RING ceiling mounted

TYPE	Ø-H (mm)	ORDER CODE
MOVE IT 25S/25	50-88	050-051021

# PAL

decorative inset 25/25S

**INSET POWER** in watts is the current consumption excluding any ballast  
**LUMINOUS FLUX** value calculated for CRI ≥ 90, colour white, glass

**Restaurant**  
Visualisation



← back



**Quickinfo**

2700 K  
 CRI ≥ 95, 3 SDCM  
 up to 97lm/W  
 L90 @ 50 000h  
 non DIM, DALI-2

**Types**

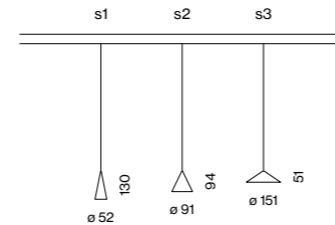

**Colours**



**Order options**

**CABLE SUSPENSION**

3000mm	5
3000mm with hook	6

**COLOUR TEMPERATURE**

2700K	
-------	--

**CONTROL**

non DIM	1
DALI-2	3

**MATERIAL COLOUR**

○ traffic white RAL 9016	7
● jet black RAL 9005	8

**ACCESSORY COLOUR**

○ pure white RAL 9010	7
● jet black RAL 9005	8

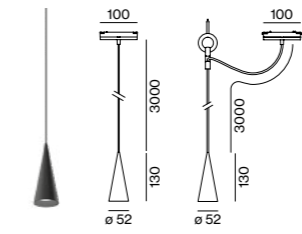

**w201 Extra small pendant s1**



**DOWNLIGHT**

<b>INSET POWER</b>	<b>COLOUR TEMP.</b>	<b>LUMINOUS FLUX</b>	<b>ORDER CODE</b>
6W	2700K	445lm	050-04814

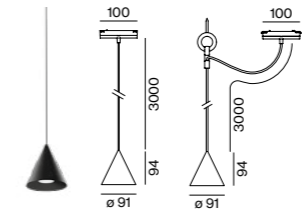

**w201 Extra small pendant s2**



**DOWNLIGHT**

<b>INSET POWER</b>	<b>COLOUR TEMP.</b>	<b>LUMINOUS FLUX</b>	<b>ORDER CODE</b>
6W	2700K	509lm	050-04824

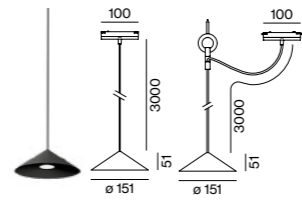

**w201 Extra small pendant s3**



**DOWNLIGHT**

<b>INSET POWER</b>	<b>COLOUR TEMP.</b>	<b>LUMINOUS FLUX</b>	<b>ORDER CODE</b>
6W	2700K	579lm	050-04834

**Mounting accessories**

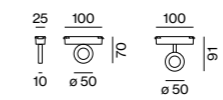

**RING track mounted**

<b>TYPE</b>	<b>Ø-H (mm)</b>	<b>ORDER CODE</b>
MOVE IT 25 S	50-70	050-151011
MOVE IT 25	50-91	050-051011



**RING ceiling mounted**

<b>TYPE</b>	<b>Ø-H (mm)</b>	<b>ORDER CODE</b>
MOVE IT 25S/25	50-88	050-051021

**wästberg**  
**w201 Extra small pendant**

Design by Claesson Koivisto Rune

**INSET POWER** in watts is the current consumption excluding any ballast  
**LUMINOUS FLUX** value calculated for CRI ≥ 95, colour white



← back

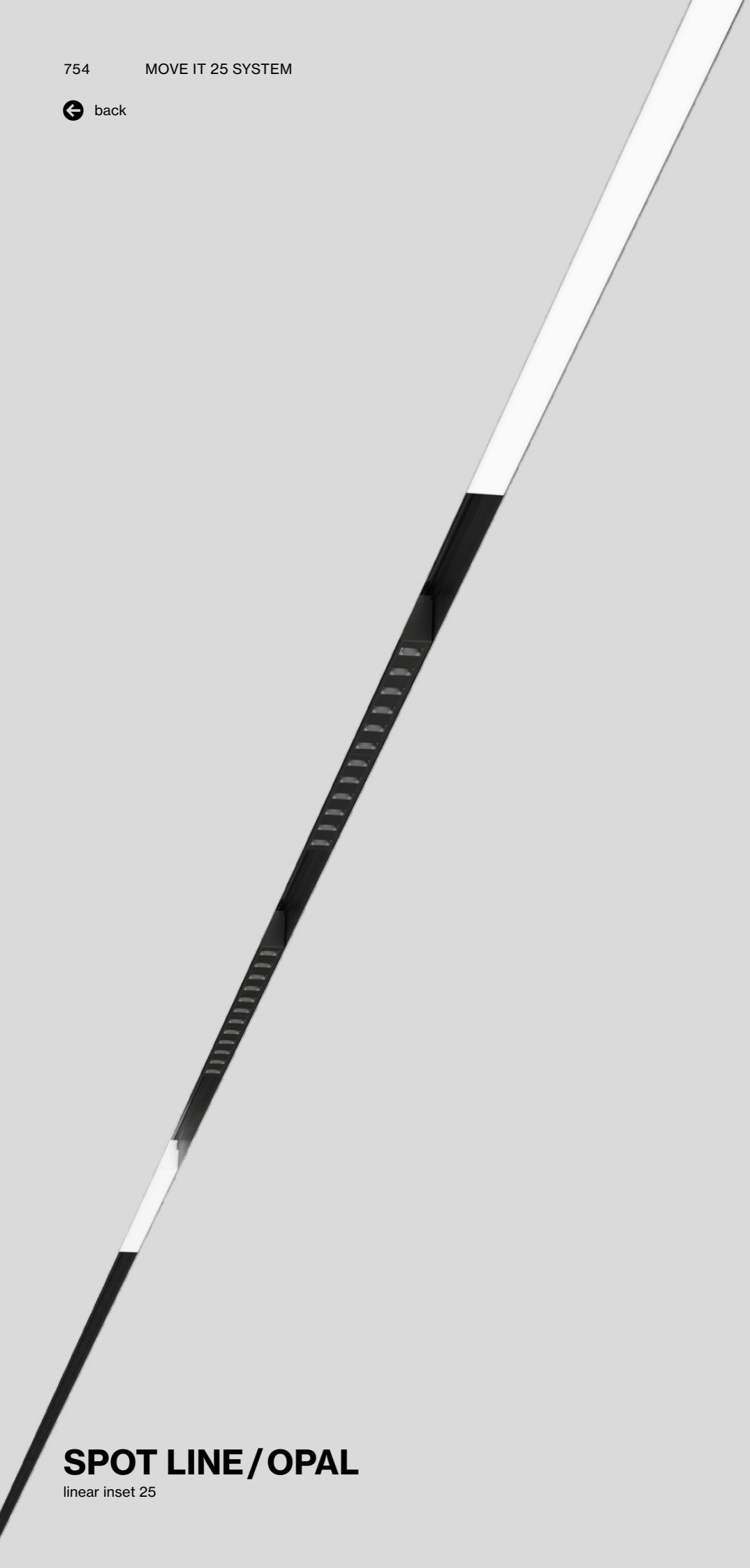

# SPOT LINE / OPAL

linear inset 25

## Quickinfo

2700K, 3000K, TW (opal)  
 CRI ≥ 90, 3 SDCM  
 SPOT LINE up to 80 lm/W  
 OPAL up to 109 lm/W  
 L80 @ 50 000 h  
 non DIM, DALI-2

## Types

MOVE IT 25

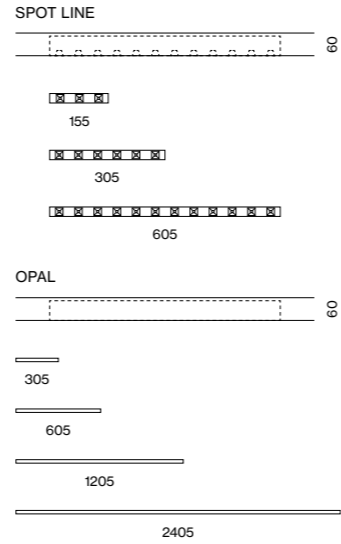

## Light distributions

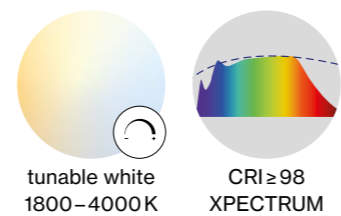
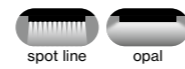

## Order options

COLOUR TEMPERATURE	
2700K	4
3000K	5
tunable white 1800-4000K*	L

\*only available for opal high performance inset | DALI-2 DT8

CONTROL	
non DIM	1
DALI-2	3

## MATERIAL COLOUR

● jet black RAL 9005

## Options on request

COLOUR RENDERING INDEX  
 CRI ≥ 98 XPECTRUM

COLOUR TEMPERATURE  
 4000K

## Light distribution

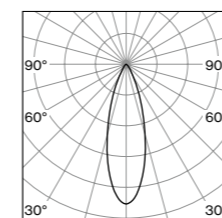

spot line

**INSET POWER** in watts is the current consumption excluding any ballast  
**LUMINOUS FLUX** value calculated for CRI ≥ 90, colour black

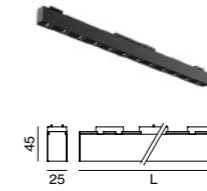

## LIGHT INSET 25



### SPOT LINE

INS. POWER	COLOUR TEMP.	LUM. FLUX	L (mm)	ORDER CODE
3 × 1.4 W	2700K	309lm	155	050-0220 :: 8 M
	3000K	336lm		
6 × 1.4 W	2700K	618lm	305	050-0221 :: 8 M
	3000K	672lm		
12 × 1.4 W	2700K	1240lm	605	050-0222 :: 8 M
	3000K	1340lm		

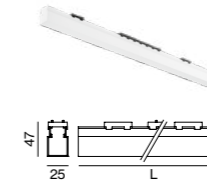

### OPAL HIGH PERFORMANCE

INS. POWER	COLOUR TEMP.	LUM. FLUX	L (mm)	ORDER CODE
5 W	2700K	445lm	305	050-0211 :: 8 H
	3000K	477lm		
10 W	2700K	890lm	605	050-0212 :: 8 H
	3000K	954lm		
17 W	2700K	1780lm	1205	050-0214 :: 8 H
	3000K	1910lm		
35 W	2700K	3560lm	2405	050-0218 :: 8 H
	3000K	3820lm		

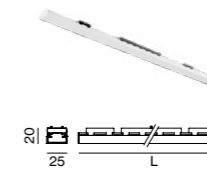

## LIGHT INSET 25 S



### OPAL HIGH PERFORMANCE

INS. POWER	COLOUR TEMP.	LUM. FLUX	L (mm)	ORDER CODE
5 W	2700K	397lm	305	050-1211 :: 8 H
	3000K	426lm		
10 W	2700K	795lm	605	050-1212 :: 8 H
	3000K	851lm		
17 W	2700K	1590lm	1205	050-1214 :: 8 H
	3000K	1700lm		
35 W	2700K	3180lm	2405	050-1218 :: 8 H
	3000K	3410lm		

canyon solution for MOVE IT 25



**Private Residence** Sofia, BG –  
by Modify studio, Arch Kamelia  
Georgieva



**ReFuture Clinic** Kiev, UA –  
by YODEZEEN Architects with lighting  
design by Svetlana Osadcha

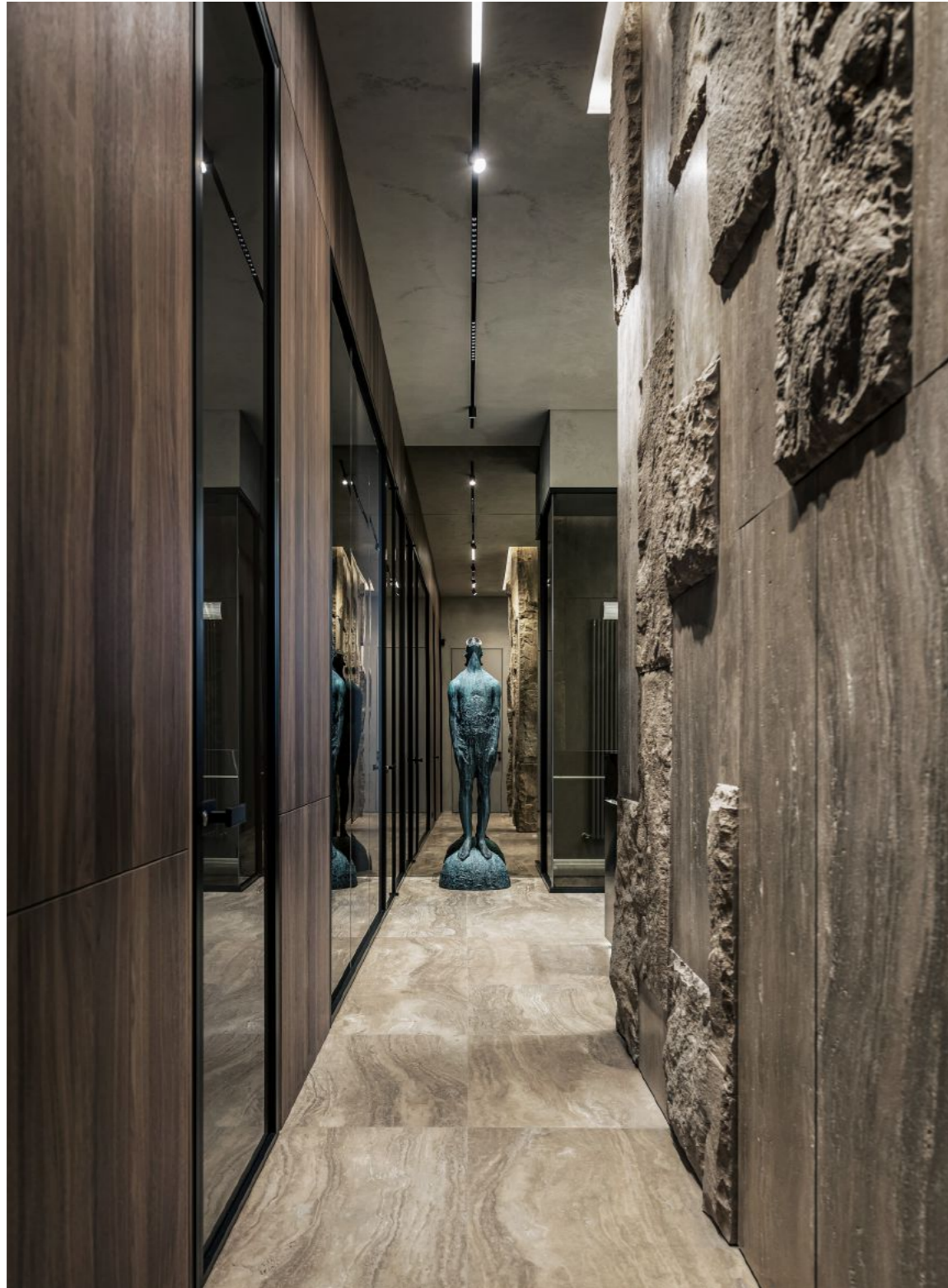

**Deansgate Square** Manchester, UK –  
by Lister & Lister with lighting design  
by Troup, Bywaters & Anders Lighting

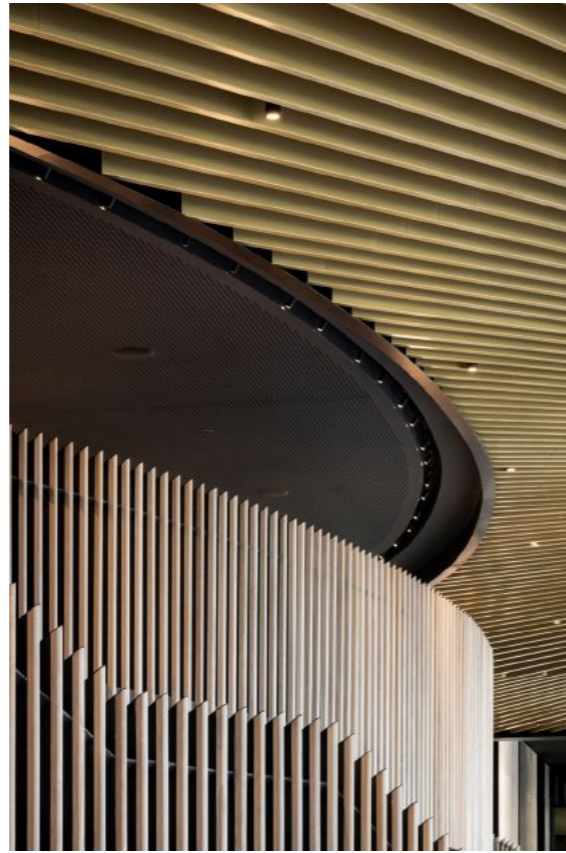

**Aertssen Group**  
Beveren, BE –  
by Mertens Architecten



← back



# WALLWASHER

linear inset 25/25 S

## Quickinfo

2700 K, 3000 K  
 CRI ≥ 90, 3 SDCM  
 WALLWASHER up to 81lm/W  
 WW flush up to 77lm/W  
 L80 @ 50 000 h  
 non DIM, DALI-2

## Types

MOVE IT 25

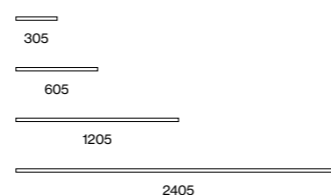
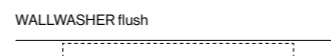
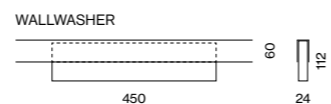

MOVE IT 25 S

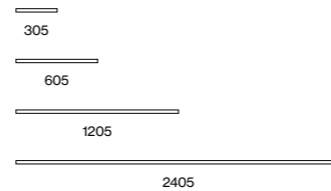

## Light distribution

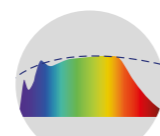

CRI ≥ 98  
 XPECTRUM

## Order options

COLOUR TEMPERATURE	
2700K	4
3000K	5

CONTROL	
non DIM	1
DALI-2	3

## MATERIAL COLOUR

● jet black RAL 9005

## Options on request

COLOUR RENDERING INDEX  
 CRI ≥ 98 XPECTRUM

COLOUR TEMPERATURE  
 4000K

## Light distributions

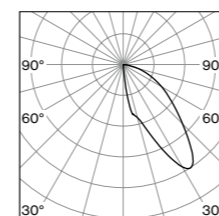

wallwasher

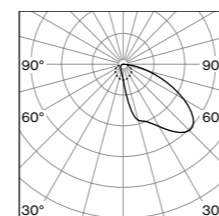

wallwasher flush

**INSET POWER** in watts is the current consumption excluding any ballast  
**LUMINOUS FLUX** value calculated for CRI ≥ 90, colour black



## LIGHT INSET 25

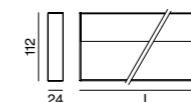

### WALLWASHER

INS. POWER	COLOUR TEMP.	LUM. FLUX	L (mm)	ORDER CODE
13 W	2700 K	983 lm	450	0 50-0 2 3 2 :: 3 8 A
	3000 K	1050 lm		

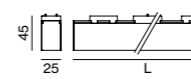
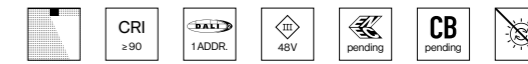

### WALLWASHER FLUSH

INS. POWER	COLOUR TEMP.	LUM. FLUX	L (mm)	ORDER CODE
5 W	2700 K	329 lm	305	0 50-0 2 1 1 :: 8 A
	3000 K	367 lm		
11 W	2700 K	658 lm	605	0 50-0 2 1 2 :: 8 A
	3000 K	735 lm		
19 W	2700 K	1320 lm	1205	0 50-0 2 1 4 :: 8 A
	3000 K	1470 lm		
38 W	2700 K	2630 lm	2405	0 50-0 2 1 8 :: 8 A
	3000 K	2940 lm		

## Optical accessories

### ANTI-GLARE GRID

TYPE	L-W (mm)	ORDER CODE
WALLWASHER FLUSH	303-25	0 50-0 2 3 0 9 1 8

cluster solution to create anti-glare grid for all lengths



## LIGHT INSET 25 S

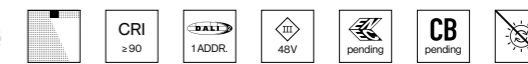

### WALLWASHER FLUSH

INS. POWER	COLOUR TEMP.	LUM. FLUX	L (mm)	ORDER CODE
5 W	2700 K	329 lm	305	0 50-1 2 1 1 :: 8 A
	3000 K	367 lm		
11 W	2700 K	658 lm	605	0 50-1 2 1 2 :: 8 A
	3000 K	735 lm		
19 W	2700 K	1320 lm	1205	0 50-1 2 1 4 :: 8 A
	3000 K	1470 lm		
38 W	2700 K	2630 lm	2405	0 50-1 2 1 8 :: 8 A
	3000 K	2940 lm		

**Jewelery + Optical Store**

Ludwigsburg, DE –

by Ippolito FleitzGroup – Identity Architects



← back

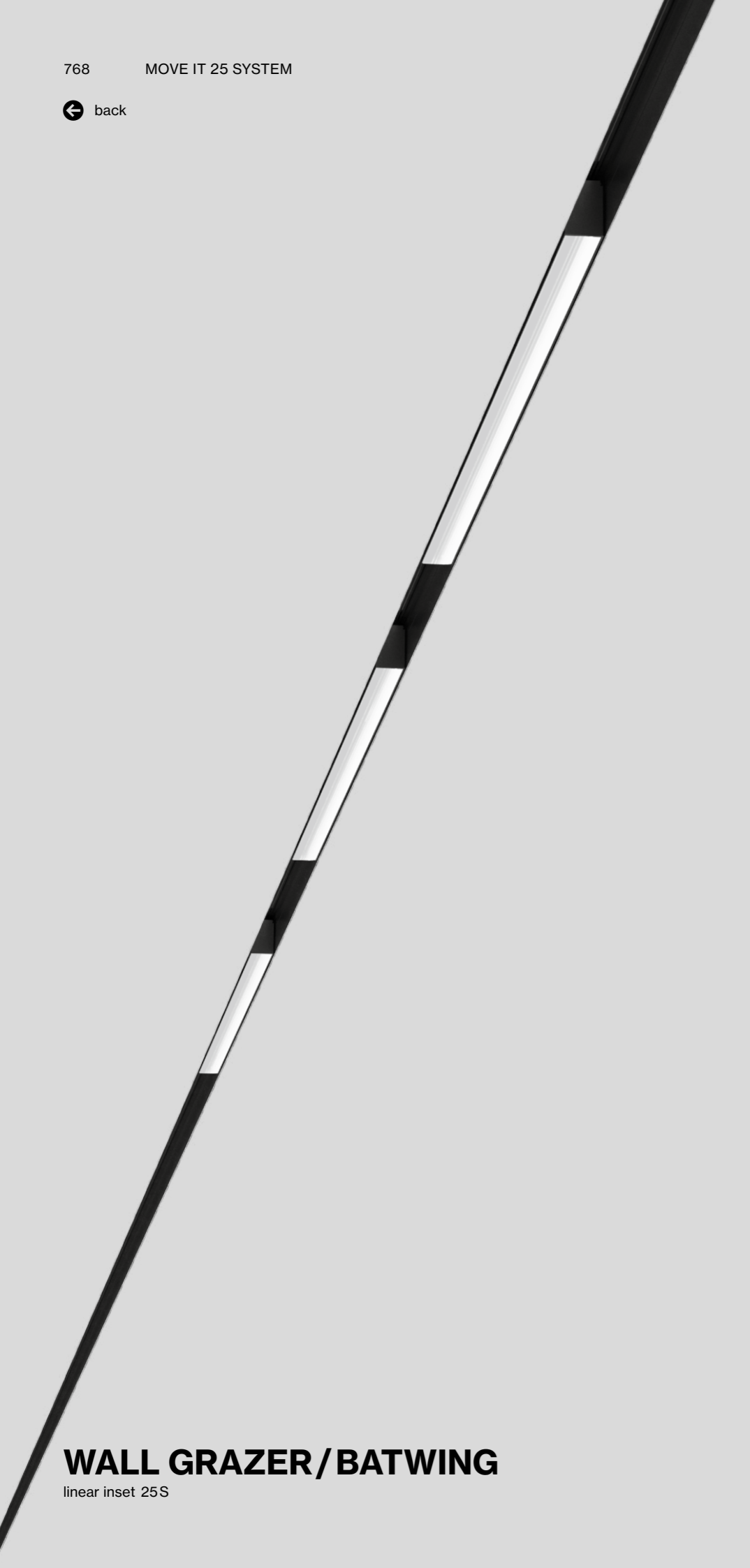

# WALL GRAZER/BATWING

linear inset 25S

## Quickinfo

2700 K, 3000 K  
 CRI ≥ 90, 3 SDCM  
 WALL GRAZER up to 127lm/W  
 BATWING up to 124lm/W  
 L80 @ 50 000h  
 non DIM, DALI-2

## Types

MOVE IT 25 S

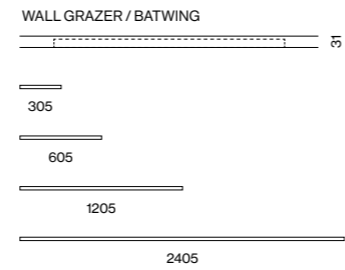

## Light distributions

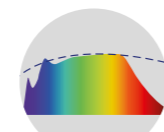

CRI ≥ 98  
 XPECTRUM

## Order options

COLOUR TEMPERATURE	
2700 K	4
3000 K	5

CONTROL	
non DIM	1
DALI-2	3

MATERIAL COLOUR	
● jet black RAL 9005	

## Options on request

COLOUR RENDERING INDEX	
CRI ≥ 98 XPECTRUM	

COLOUR TEMPERATURE	
4000 K	

## Light distributions

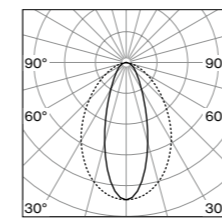

wall grazer

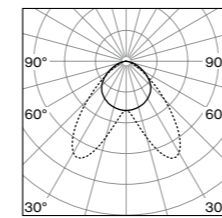

batwing

**INSET POWER** in watts is the current consumption excluding any ballast  
**LUMINOUS FLUX** value calculated for CRI ≥ 90, colour black

## LIGHT INSET 25 S

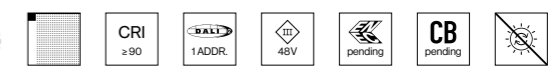
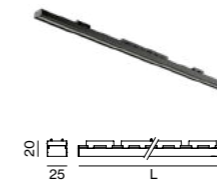

WALL GRAZER					
INS. POWER	COLOUR TEMP.	LUM. FLUX	L (mm)	ORDER CODE	
5 W	2700 K	518 lm	305	0 5 0 - 1 2 1 1 :: ⇨ 8 S	
	3000 K	555 lm			
10 W	2700 K	1040 lm	605	0 5 0 - 1 2 1 2 :: ⇨ 8 S	
	3000 K	1110 lm			
17 W	2700 K	2070 lm	1205	0 5 0 - 1 2 1 4 :: ⇨ 8 S	
	3000 K	2220 lm			
35 W	2700 K	4150 lm	2405	0 5 0 - 1 2 1 8 :: ⇨ 8 S	
	3000 K	4440 lm			

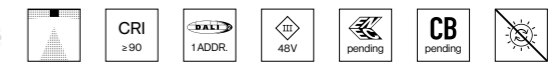
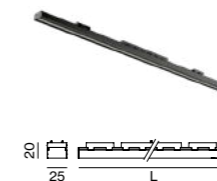

BATWING					
INS. POWER	COLOUR TEMP.	LUM. FLUX	L (mm)	ORDER CODE	
5 W	2700 K	506 lm	305	0 5 0 - 1 2 1 1 :: ⇨ 8 B	
	3000 K	542 lm			
10 W	2700 K	1010 lm	605	0 5 0 - 1 2 1 2 :: ⇨ 8 B	
	3000 K	1080 lm			
17 W	2700 K	2020 lm	1205	0 5 0 - 1 2 1 4 :: ⇨ 8 B	
	3000 K	2170 lm			
35 W	2700 K	4040 lm	2405	0 5 0 - 1 2 1 8 :: ⇨ 8 B	
	3000 K	4330 lm			



**Dental Practice Coornaert -  
Tandartscentrum Atlas**  
Kortrijk, BE – by Maison Jane

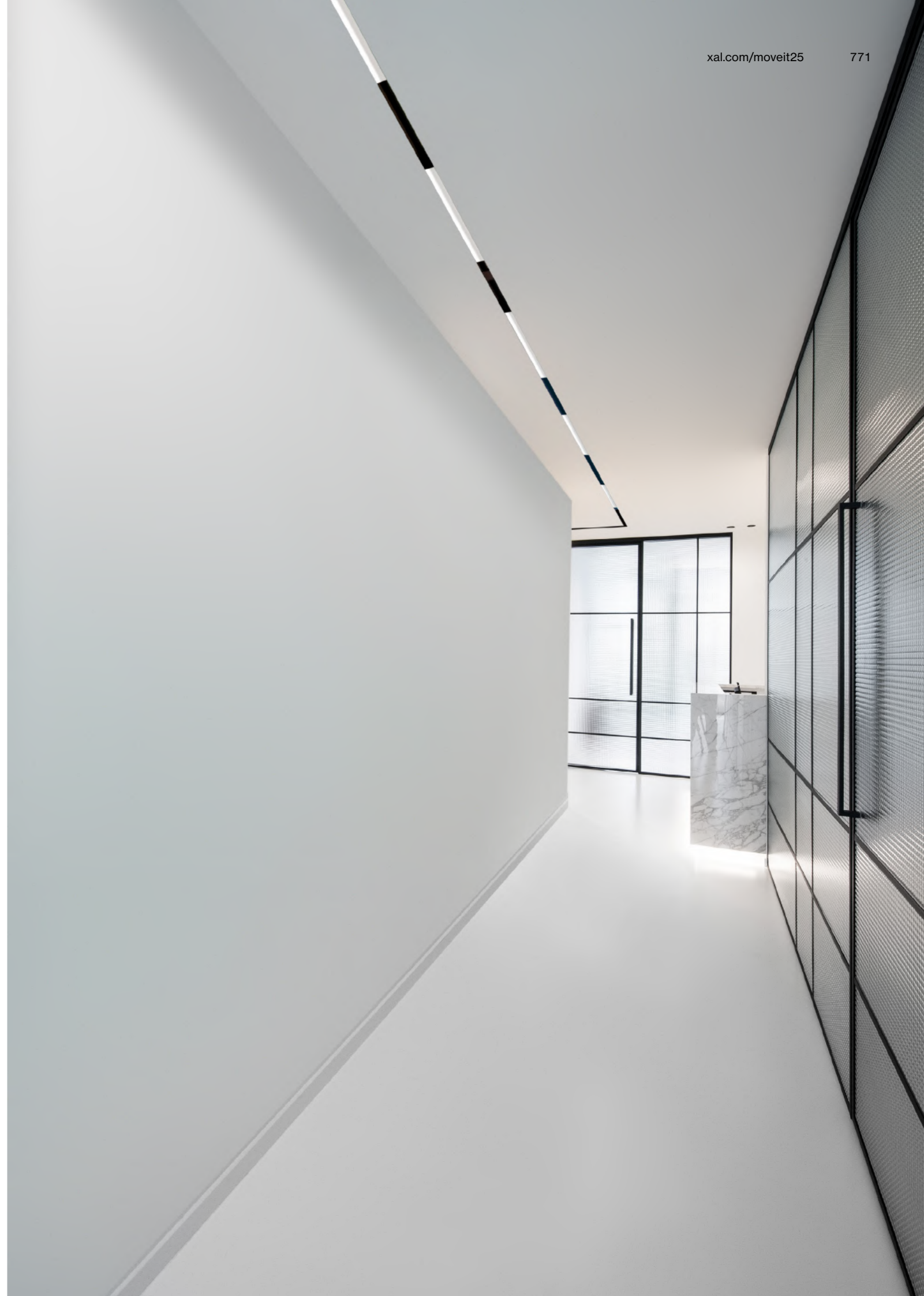

← back

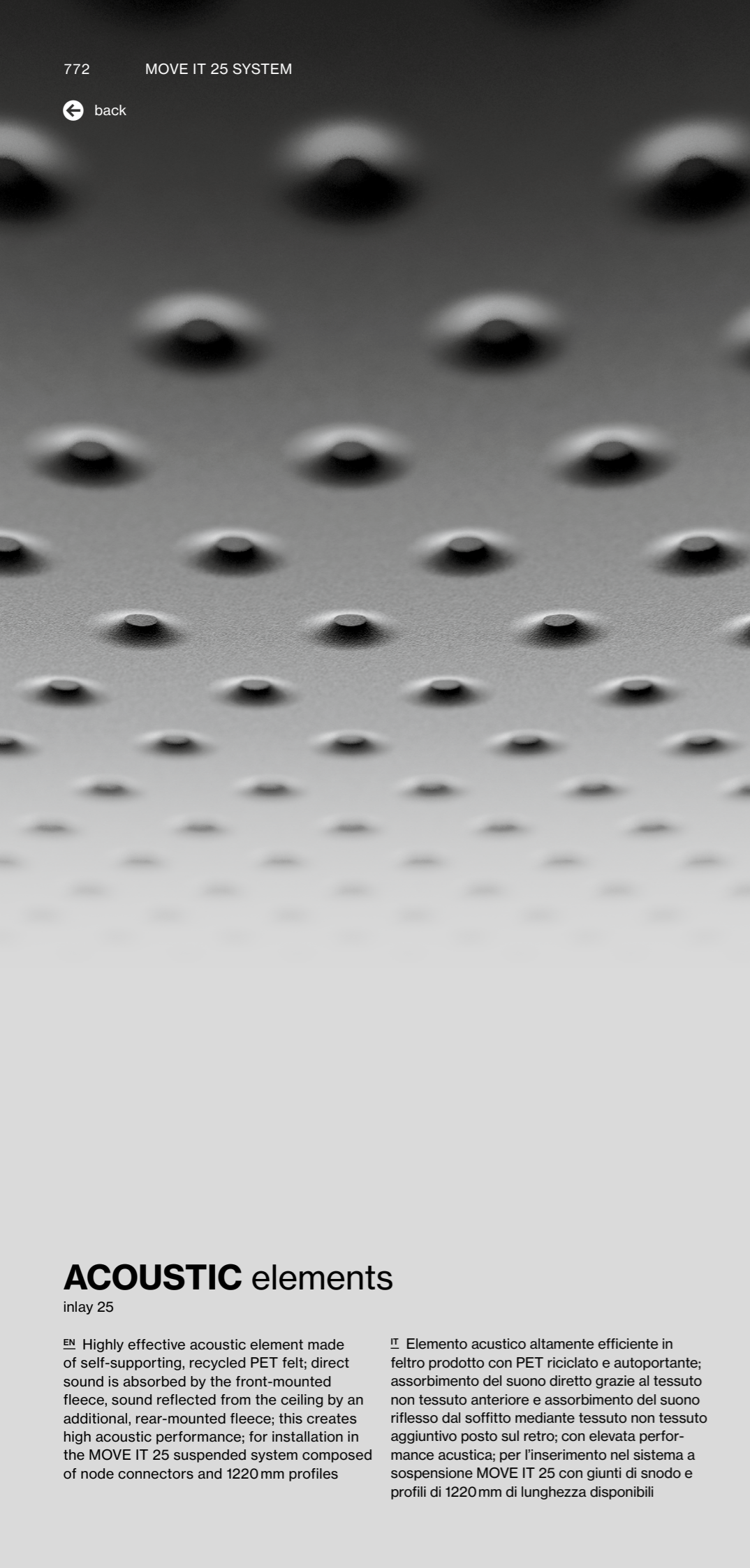

**Quickinfo**

PET felt  
 ♻️ from recycled material  
 up to absorption class A

**Types**

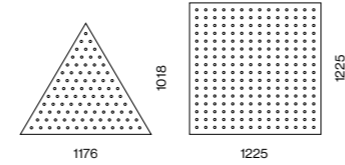

**Colours**



**Order options**

**MATERIAL COLOUR**   
 ○ white W  
 ● black L

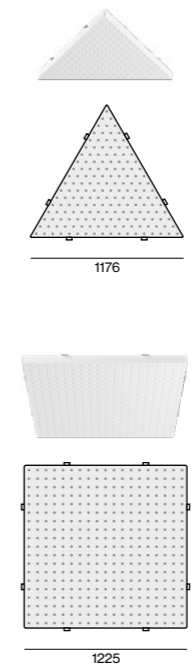

**MOVE IT 25 suspended**

**MOVE IT ACOUSTIC TRIANGLE**

TYPE	L-W-H (mm)	ORDER CODE
1200 inlay MOVE IT system*	1176-1018-57	050-230122

\*NODE connector + track 1220mm

**MOVE IT ACOUSTIC SQUARE**

TYPE	L-W-H (mm)	ORDER CODE
1200 inlay MOVE IT system*	1225-1225-57	050-230222

\*NODE connector + track 1220mm

**ACOUSTIC EXAMPLES**

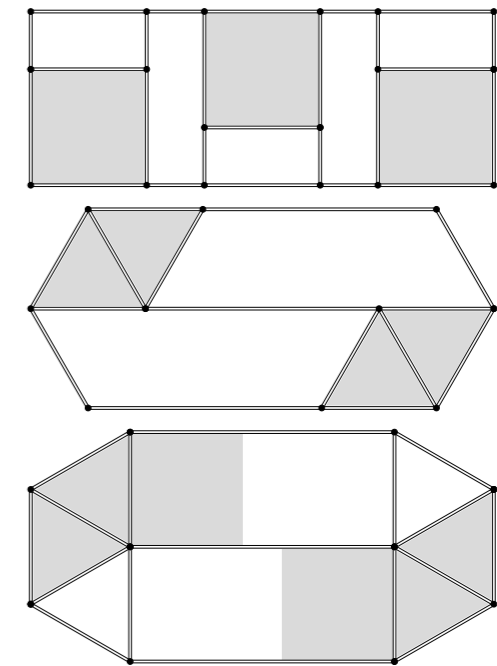

**ACOUSTIC elements**

inlay 25

EN Highly effective acoustic element made of self-supporting, recycled PET felt; direct sound is absorbed by the front-mounted fleece, sound reflected from the ceiling by an additional, rear-mounted fleece; this creates high acoustic performance; for installation in the MOVE IT 25 suspended system composed of node connectors and 1220 mm profiles

IT Elemento acustico altamente efficiente in feltro prodotto con PET riciclato e autoportante; assorbimento del suono diretto grazie al tessuto non tessuto anteriore e assorbimento del suono riflesso dal soffitto mediante tessuto non tessuto aggiuntivo posto sul retro; con elevata performance acustica; per l'inserimento nel sistema a sospensione MOVE IT 25 con giunti di snodo e profili di 1220mm di lunghezza disponibili

has-to-be gmbH  
Radstadt, AT



**FlexOffice, Messeturm Basel**  
Basel, CH



# Office on track

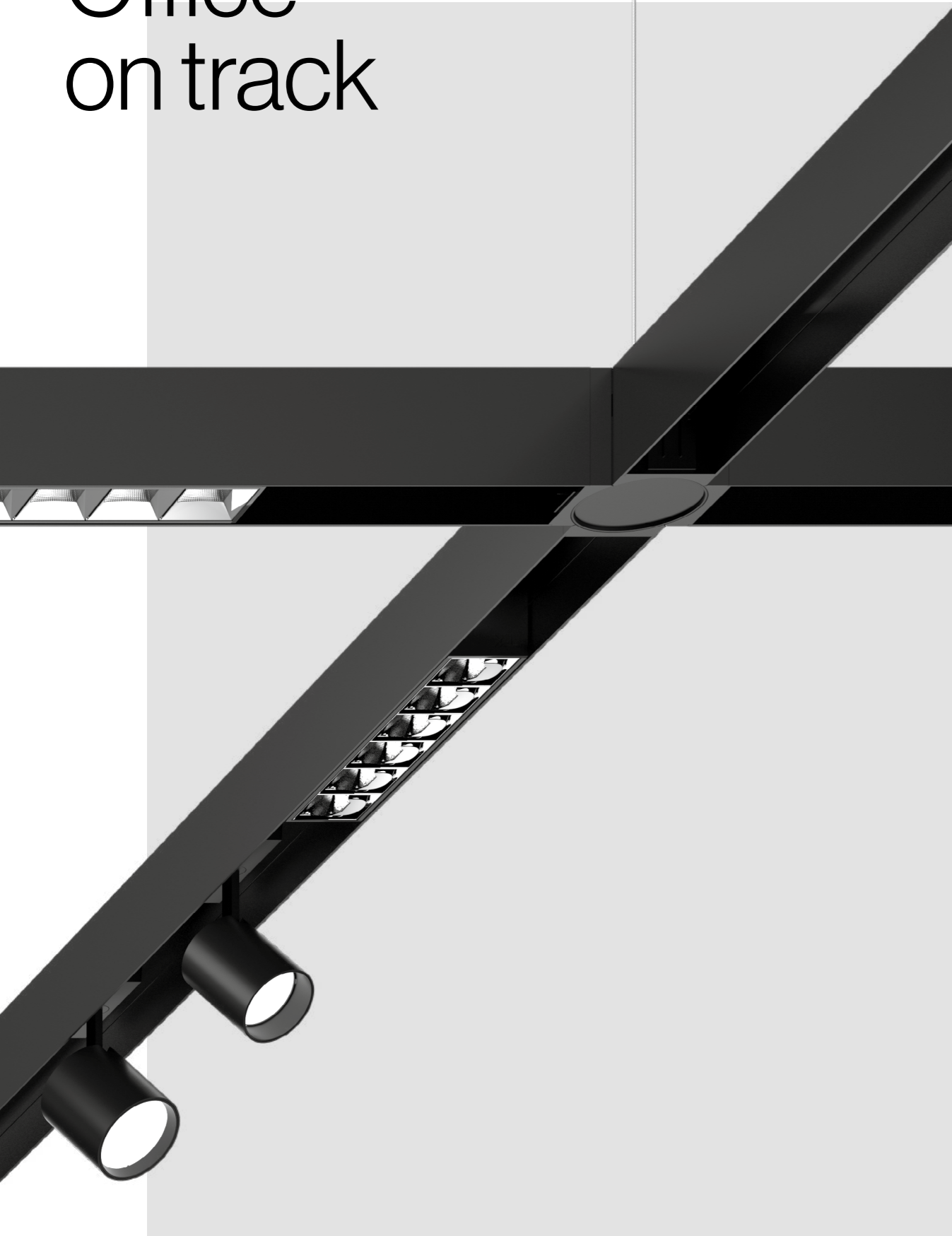

## MOVE IT 45 system

**EN** MOVE IT 45 offers glare-free office lighting with the flexibility of a track system. It is available as a suspended version, or as a recessed or surface-mounted variant for wall or ceiling mounting. Indirect light for homogeneous ceiling illumination is available as an option. The profiles are connected using corner elements or NODE connectors. Spotlights, linear office insets, and decorative luminaires are installed in the system without tools and can be flexibly adapted to changes in the room. With just one track system and the appropriate insets, completely different areas in the office – such as workstations, meeting rooms, and corridors – can be individually illuminated and controlled. Square acoustic elements that can be optionally integrated additionally create balanced room acoustics.

**IT** Luce perfettamente schermata in ufficio e tutta la flessibilità di un sistema a binari portanti: MOVE IT 45 si monta ad incasso o plafone, su pareti e soffitti, a sospensione, volendo anche con emissione indiretta per una luminosità uniforme sul soffitto. I profili si collegano con giunti angolari oppure con un NODE Connector. Faretto, moduli lineari per illuminazione di uffici e corpi illuminanti decorativi si combinano nello stesso sistema adattandosi con flessibilità ad ogni modifica di layout. E tutti si fissano senza bisogno di attrezzi. Il risultato è un singolo sistema di binari portanti che vengono equipaggiati con gli elementi più adatti ad ogni tipo di ambiente, come uffici, sale riunioni o corridoi. È inoltre possibile aggiungere pannelli fonoassorbenti quadrati per migliorare l'acustica.

### Type



45

### Mountings

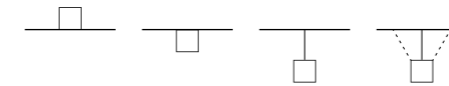
trimless  
recessed

ceiling

suspended

indirect  
suspended

### Configurations



linear

corner

node

### Light distributions

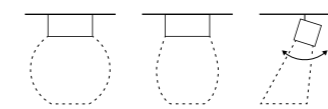

opal

reflector  
(UGR ≤ 19)

spotlight

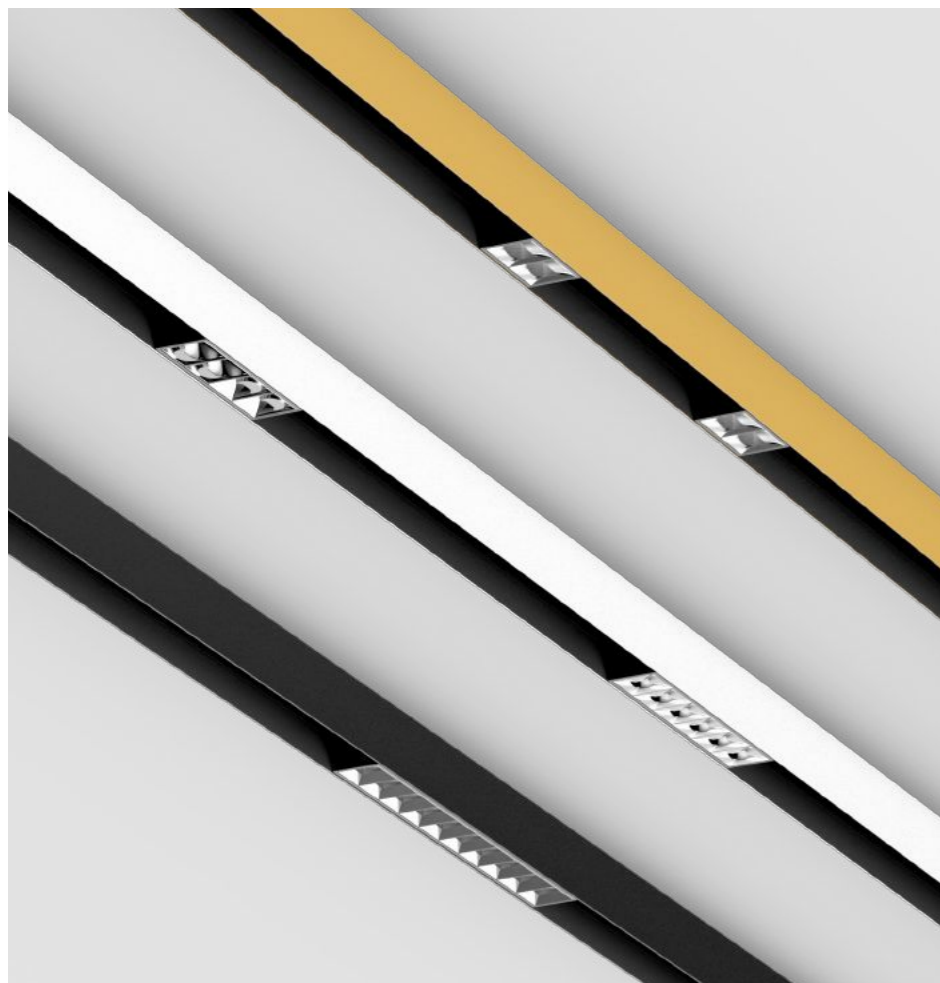

## Colour variety

EN MOVE IT profiles are available in various standard colours. Further colour variations are also available, granting your project maximum design freedom. You can learn more about our colour palette at [xal.com/colours](http://xal.com/colours).

IT I profili MOVE IT sono disponibili in diversi colori standard. Oltre a questi, si possono scegliere anche altri colori speciali in modo da personalizzare il progetto. Per conoscere la gamma di colori consultare [xal.com/colours](http://xal.com/colours).



[xal.com/colours](http://xal.com/colours)

## Individual grids & room acoustics

EN The NODE Connector lets you create different ceiling patterns from up to four MOVE IT 45 profiles per node. Create attractive geometric shapes by connecting the profiles at a 90° angle. Special corner connectors that are rotated 35° to the left and right provide even more design freedom. Simply extend the MOVE IT Suspended System with square acoustic elements for optimised room acoustics.

IT Con il NODE Connector si compongono forme diversificate sul soffitto collegando fino a quattro profili MOVE IT 45 per ogni snodo. Unendo i profili ad angoli di 90°, si ricavano corrispondenti forme geometriche. La libertà compositiva aumenta con giunti angolari speciali che si ruotano di 35° a destra e sinistra. In aggiunta, quando si richiede il miglioramento acustico, si può integrare il sistema MOVE IT a sospensione aggiungendo pannelli acustici quadrati.



## Mounting options

EN The elegant MOVE IT 45 System offers a wide variety of installation options: as a trimless recessed or surface-mounted variant for wall or ceiling mounting and suspended. The suspended direct/indirect variant provides additional homogeneous ceiling illumination.

IT MOVE IT 45 è un sistema slanciato ed elegante, con molte opzioni di montaggio: incasso senza cornice, plafone su pareti e soffitti e a sospensione. La variante a luce diretta/indiretta aggiunge una luminosità omogenea sul soffitto.

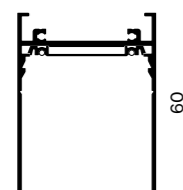

45

## XPECTRUM LED

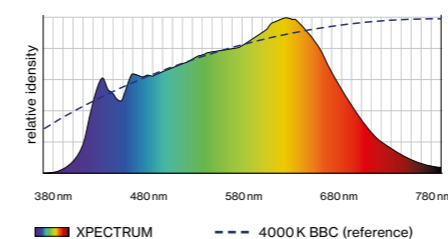

## Commercially available LED 4000K

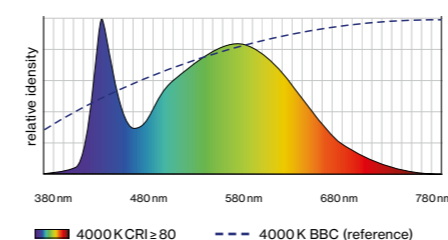

## Full-spectrum LED

EN XAL's new XPECTRUM LEDs deliver healthy, biologically effective light. The reduced blue light and increased cyan values reduce the blue light hazard for the eye to daylight-equivalent levels. The resulting non-visual, so-called melanopic light effect, improves concentration and increases sleep quality. The excellent colour rendering of IES TM 30-15  $R_i = 98$  and  $R_g = 101$  further helps visual comfort. These LEDs are available for different MOVE IT System insets and indirect insets.

IT Il nuovo XPECTRUM LED di XAL assicura una luce sana con efficacia biologica. Lo spettro riduce le componenti azzurre e aumenta invece il ciano, con il risultato di una luce simile a quella diurna in cui i rischi per gli occhi dell'azzurro sono contenuti al minimo. Ne consegue un effetto non visivo, chiamato anche melanopico, che favorisce la concentrazione e migliora la qualità del sonno. Inoltre l'eccellente resa cromatica IES TM 30-15  $R_i = 98$  e  $R_g = 101$  migliora il comfort visivo. Avete a disposizione LED di questo tipo per varie unità (inset) fra cui quelle a luce indiretta del sistema MOVE IT.

## Variety of office reflector insets

EN Office lighting faces various requirements, ranging from standards for workplace lighting ( $UGR \leq 19$ ), homogeneous basic illumination, to spot accentuation. Changing the design or use of office space also requires a flexible lighting solution. MOVE IT 45 responds to this with a wide range of lighting insets that are easily installed and replaced in the track system.

IT L'illuminazione degli uffici deve soddisfare diverse necessità: occorre una luce a norma per le postazioni di lavoro ( $UGR \leq 19$ ), una luminosità generale omogenea ma anche un'atmosfera vivacizzata da accenti luminosi. Inoltre, i frequenti cam-biamenti di layout o attività richiedono un impianto flessibile. Per questo MOVE IT 45 offre un'ampia scelta di inserti luminosi che si montano sui binari portanti e possono essere sostituiti senza complicazioni.



## Control options

EN MOVE IT Insets are available with DALI-2 and can be controlled individually. Configuration and control are simply done via DALI. As the open DALI communication standard is fully supported, all compatible luminaires can be easily integrated into the system. The Wireless-to-DALI Inset enables wireless control of DALI luminaire systems by using a communication module.

IT Gli inserti MOVE IT sono disponibili in variante DALI-2 per il controllo individuale. In questo caso la configurazione e il comando avvengono via DALI. Dal momento che viene assistito pienamente lo standard aperto di comunicazione DALI, è possibile integrare senza problemi qualsiasi apparecchio compatibile. L'elemento Wireless to DALI permette di controllare il sistema d'illuminazione senza bisogno di cavi, utilizzando un modulo di comunicazione.

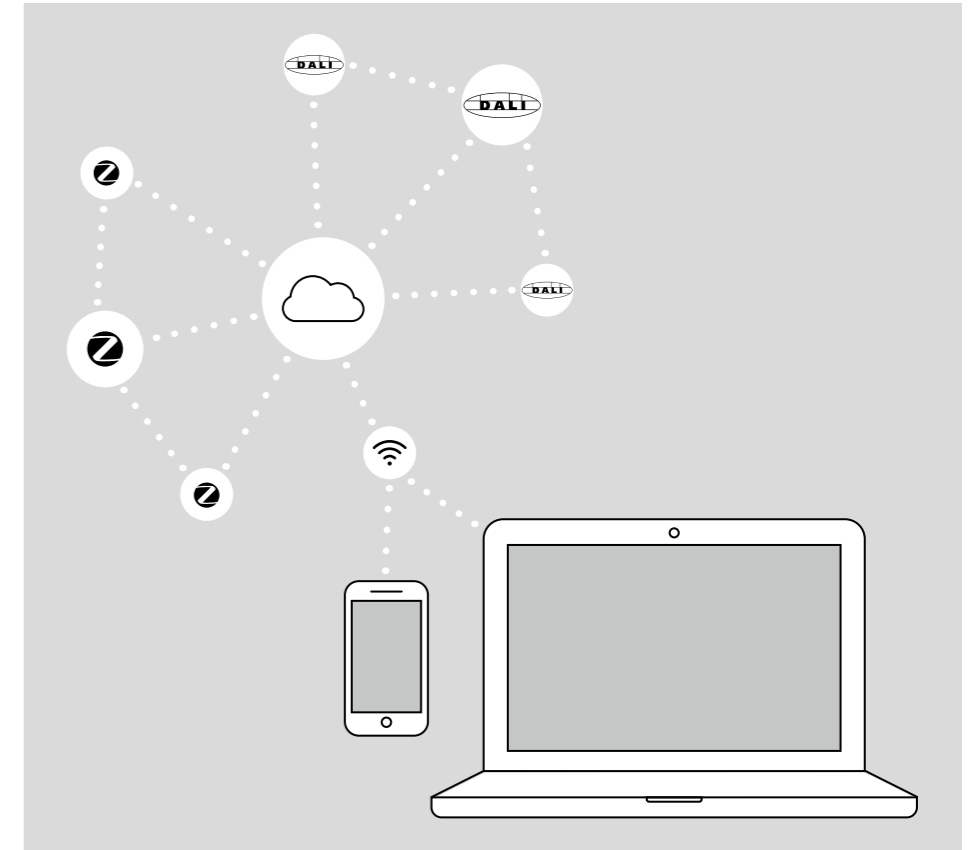

## Light optics

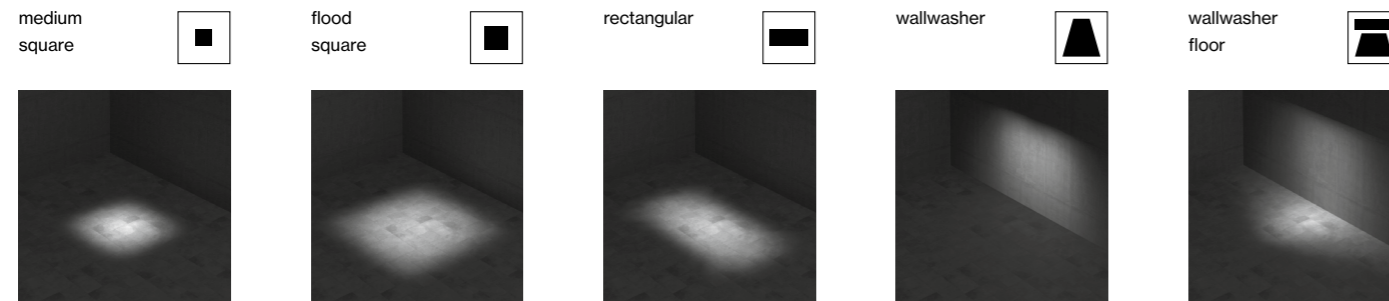

## Inset variety

### L1 Applications



### L2 Applications



### L24 OFFICE $UGR \leq 19$



### L4 Applications



### L6 Applications



### L10 OFFICE $UGR \leq 19$



### OPAL



## IoT ready

EN IoT ready refers to the possibility of equipping luminaires with smart sensor technology. You receive valuable information, such as your lighting system's energy consumption or your rooms' utilisation over the day. You can set shut-off delay times and brightness values or plan time-controlled light sequences. The sensor is magnetically inserted into the track system like a spotlight and can be individually configured without restriction by existing standards.

IT IoT ready descrive la possibilità di equipaggiare gli apparecchi d'illuminazione con sensori smart. In questo modo otterrete informazioni preziose, come ad esempio il consumo energetico dell'impianto oppure il grado di utilizzo dei vostri spazi nell'arco della giornata. Inoltre potete programmare tempi di reazione e livelli di luminosità, oppure definire sequenze su base oraria. I sensori si montano nei binari elettrificati con un fissaggio magnetico, esattamente come i farette, e si configurano in modo individuale senza limiti legati agli standard in uso.

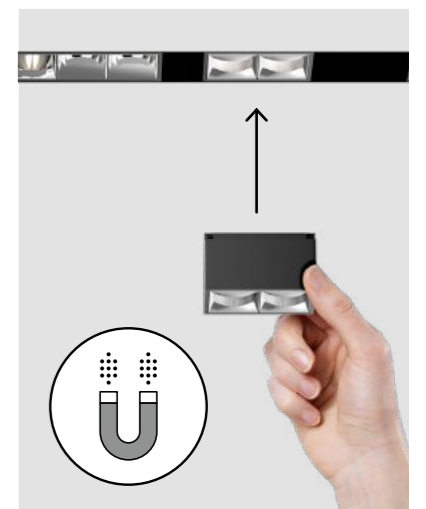
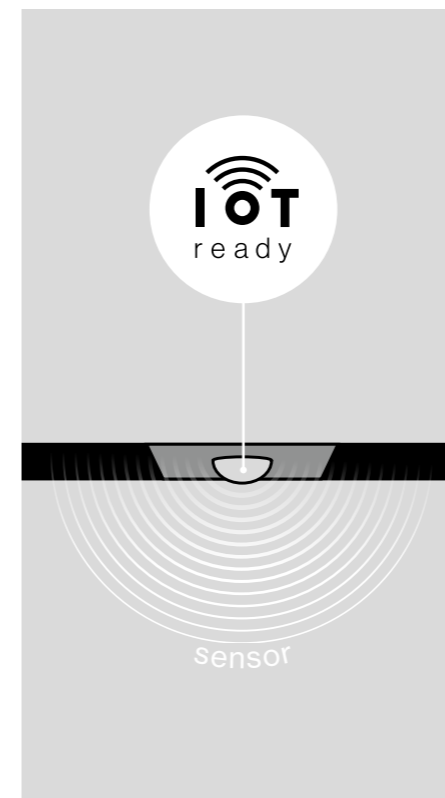

## Magnetic attachment

EN MOVE IT Insets are mounted without tools and magnetically fixed within the profile. They can, therefore, be adjusted and adapted according to the lighting requirements with just one movement.

IT Gli inserti luminosi MOVE IT si fissano all'interno dei profili con un sistema magnetico, senza bisogno di attrezzatura. Pertanto, basta un semplice gesto per spostarle e adattarle alle esigenze d'illuminazione.



## MOVE IT 45 system

trimless / surface / suspended

EN Extruded aluminium profile with 45 mm width groove; for trimless installation in plasterboard ceilings (wall or ceiling mounting) with 12.5 mm ceiling thickness; or for wall-/ceiling surface mounting or suspended mounting (cable suspension, height adjustment without tools, incl. black feed); optional with indirect light component for additional accentuation of the ceiling; for lighting systems, 90° angle connectors for flexible system design; node connectors, up to 4 profile connection options; with power track profile for take off of supply voltage and DALI signal; surf. anod. or powder coated; insets can be installed flexibly and without tools by means of magnetic holders + locking; sound absorbing accessories available

IT Profilo di alluminio estruso con fuga larga 45 mm; per mont. senza cornice in soffitti di cartongesso (a parete o a soffitto) con spessore 12,5 mm; o per montaggio a parete/soffitto o montaggio a sospensione (cavo di sospensione, regolazione in altezza senza attrezzi, cavo di alimentazione nero incluso); in opzione con aggiunta di luce indiretta per accenti sul soffitto; per sistemi di illuminazione, giunto angolare a 90° per composizioni flessibili; connettori NODE, un massimo di 4 possibili modalità di attacco del profilo; con binario elettrificato per la riduzione della tensione di alimentazione e segnale DALI; sup. anod. o verniciata a polvere; installazione flessibile e senza attrezzi degli inserti tramite supporto + attacco magnetico; disponibile accessorio fonoassorbente

### Quickinfo

3000K  
CRI ≥ 90, 2 SDCM  
up to 117 lm/W  
L80 @ 50 000 h  
non DIM, DALI-2

### Types

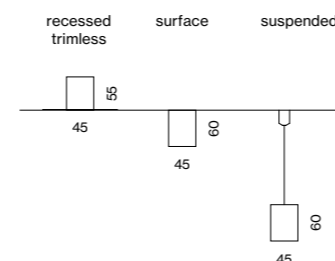

### connectors

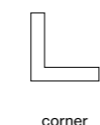
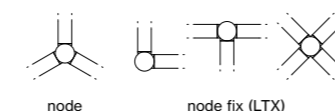

### Colours



### Order options

CONTROL	
non DIM	1
DALI-2	3

### MATERIAL COLOUR

● jet black RAL 9005

### Options on request

#### CONNECTOR

T-connector

X-connector

#### INSTALLATION TRACK

acoustic soft ceilings

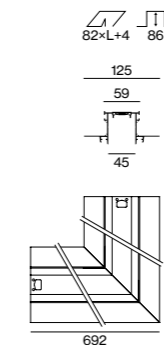

### MOVE IT 45 trimless



#### INSTALLATION TRACK

L (mm)		ORDER CODE
617	channel	050-72320-8
1217	channel	050-72340-8
2417	channel	050-72380-8
3622	channel	050-72390-8
cust. cut	channel (non DIM)	E83551-8
cust. cut	channel (DALI-2)	E83521-8
692x648	channel corner* 90°	050-72310-8
661x661	channel corner* ceiling to wall 90°	050-72311-8

\*incl. electrical connector set

### Accessories

#### END CAPS

TYPE	ORDER CODE
end caps (pair)	050-72300-8

#### BLIND COVER

L (mm)	ORDER CODE
1217	050-70340-8
2417	050-70380-8
3622	050-70390-8
custom cut	E83500-8B

blind cover can be shortened as desired

#### CONNECTOR SET

TYPE	ORDER CODE
linear connector (non DIM, DALI-2)	050-20311-30
linear connector flexible	050-20321-0
mechanical linear connector (pair)	050-20111-10

#### POWER FEEDER UNIT

TYPE	ORDER CODE
non DIM 2 × 2,5 mm <sup>2</sup>	050-20201-10
DALI-2 2 × 2,5 + 2 × 0,5 mm <sup>2</sup>	050-20201-30

cable length 500 mm

### Electrical accessories

see page 788

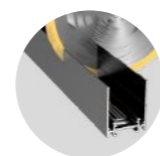

custom cut on building site



acoustic elements (p.806)



← back

**Order options**

<b>CONTROL</b>	
non DIM	1
DALI-2	3

**MATERIAL COLOUR  
INSTALLATION TRACK**

● jet black RAL 9005	8
● traffic white 9016 / jet black 9005 P	
● gold dust 260-M / jet black 9005 G	
● special colours* p.335	X

\*inside always in black

**MATERIAL COLOUR  
NODE CONNECTOR**

○ traffic white RAL 9016	7
● jet black RAL 9005	8
● special colours p.992	X

**MATERIAL COLOUR  
NODE LTX / END CAP**

● jet black RAL 9005	8
● traffic white 9016 / jet black 9005 P	
● special colours p.992	X

**MATERIAL COLOUR  
ACCESSORIES**

○ traffic white RAL 9016	7
● jet black RAL 9005	8

**NODE CONNECTOR  
MOUNTING TYPE**

surface*	1
1500 mm cable susp. chrome	3
1500 mm cable susp. black	4

\*only for L/T/X

**MATERIAL COLOUR  
CABLE SUSPENSION**

chrome	0
black	8

**Electrical accessories**

see page 788

**Acoustic elements**

see page 806



**MOVE IT 45 surface/suspended**



**INSTALLATION TRACK**

L (mm)		ORDER CODE
620	channel	050-73320
1220	channel	050-73340
2420	channel	050-73380
3625	channel	050-73390
cust. cut	channel (non DIM)	E83561
cust. cut	channel (DALI-2)	E83531
653x609	channel corner* 90°	050-73310
661x661	channel corner* ceiling to wall 90°	050-73311

\*incl. electrical connector set

**Accessories**

**END CAPS**

TYPE	ORDER CODE
end caps (pair)	050-733000

**BLIND COVER**

L (mm)	ORDER CODE
1217	050-7034008
2417	050-7038008
3622	050-7039008
custom cut	E83500 ···· 8B

blind cover can be shortened as desired

**FLEX NODE CONNECTOR**

TYPE	ORDER CODE
FLEX NODE surface mounted	050-203333
FLEX NODE surface mounted incl. feeder	050-202243
FLEX NODE cable suspension 1500mm	050-20331
FLEX NODE cable susp. 1500mm incl. feeder	050-20222
NODE end cap* incl. electrical connector	050-733010

\*order for every node connection (channel to node) 1 end cap

**FIX NODE CONNECTOR**

TYPE	ORDER CODE
L NODE incl. end cap & electrical connector	050-73354
T NODE incl. end cap & electrical connector	050-73352
X NODE incl. end cap & electrical connector	050-73353

**CONNECTOR SET**

TYPE	ORDER CODE
mechanical linear conn. incl. 1500mm cable susp.	050-201131
mechanical linear connector surface	050-2011210
mechanical & electrical linear connector	050-2031230
mechanical & electrical corner connector flex	050-2032238

**POWER FEEDER UNIT**

TYPE	ORDER CODE
non DIM 2×2,5mm <sup>2</sup>	050-2022110
DALI-2 2×2,5 + 2×0,5mm <sup>2</sup>	050-2022130

cable length 2000mm

**CEILING FASTENER / CABLE SUSPENSION / CANOPY**

TYPE	L (mm)	ORDER CODE
ceiling fastener	67	050-204121
cable suspension*	1500	005-215211
canopy		005-231121

\*use every 1200mm

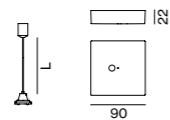
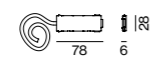
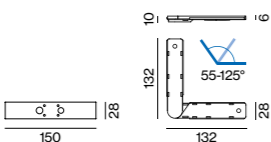
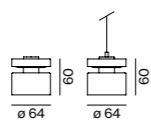
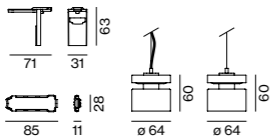
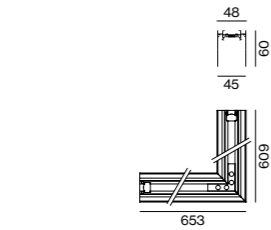

**Order options**

**COLOUR TEMPERATURE**  
3000K

<b>CONTROL</b>	
non DIM	1
DALI-2	3

**MATERIAL COLOUR  
INSTALLATION TRACK**

● jet black RAL 9005	8
● traffic white 9016 / jet black 9005 P	
● gold dust 260-M / jet black 9005 G	
● special colours* p.992	X

\*inside always in black

**MATERIAL COLOUR  
NODE CONNECTOR**

○ traffic white RAL 9016	7
● jet black RAL 9005	8
● special colours p.992	X

**MATERIAL COLOUR  
NODE LTX / END CAP**

● jet black RAL 9005	8
● traffic white 9016 / jet black 9005 P	
● special colours p.992	X

**MATERIAL COLOUR  
ACCESSORIES**

○ traffic white RAL 9016	7
● jet black RAL 9005	8

**NODE CONNECTOR  
MOUNTING TYPE**

surface*	1
1500 mm cable susp. chrome	3
1500 mm cable susp. black	4

\*only for L/T/X

**MATERIAL COLOUR  
CABLE SUSPENSION**

chrome	0
black	8

**Options on request**

**COLOUR RENDERING INDEX**  
CRI ≥ 98 XPECTRUM

**COLOUR TEMPERATURE**  
2700K  
4000K  
tunable white 2700–6500K\*

\*DALI-2 DT8

**COLOUR TEMPERATURE**  
2700K  
4000K  
tunable white 2700–6500K\*

\*DALI-2 DT8

**LUMINOUS FLUX** value calculated for 3000K, CRI ≥ 90, colour white/black



**MOVE IT 45 suspended indirect**



**INSTALLATION TRACK INDIRECT**

L (mm)	SYSTEM POWER	LUMINOUS FLUX	ORDER CODE
620	6.2W	638lm	050-74325
1220	15W	1790lm	050-74345
2420	33W	3830lm	050-74385
3625	50W	5745lm	050-74395
653x609	13W	1420lm	050-74310
corner*			

no custom cut on building side; \*incl. electrical connector set

**Accessories**

**END CAPS**

TYPE	ORDER CODE
end caps (pair)	050-733000

**BLIND COVER**

L (mm)	ORDER CODE
1217	050-7034008
2417	050-7038008
3622	050-7039008
custom cut	E83500 ···· 8B

blind cover can be shortened as desired

**FLEX NODE CONNECTOR**

TYPE	ORDER CODE
FLEX NODE cable suspension 1500mm	050-20331
FLEX NODE cable susp. 1500mm incl. feeder	050-20222
NODE end cap* incl. electrical connector	050-733010

\*order for every node connection (channel to node) 1 end cap

**FIX NODE CONNECTOR**

TYPE	ORDER CODE
L NODE incl. end cap & electrical connector	050-73354
T NODE incl. end cap & electrical connector	050-73352
X NODE incl. end cap & electrical connector	050-73353

**CONNECTOR SET**

TYPE	ORDER CODE
mechanical linear conn. incl. 1500mm cable susp.	050-201131
mechanical & electrical linear connector	050-2031230
mechanical & electrical corner connector flex	050-2032238

**POWER FEEDER UNIT**

TYPE	ORDER CODE
non DIM 2×2,5mm <sup>2</sup>	050-2022110
DALI-2 2×2,5 + 2×0,5mm <sup>2</sup>	050-2022130

cable length 2000mm

**CABLE SUSPENSION / CANOPY**

TYPE	L (mm)	ORDER CODE
cable suspension*	1500	005-215211
canopy		005-231121

\*use every 1200mm

**Electrical accessories**

see page 788

**Acoustic elements**

see page 806

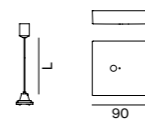
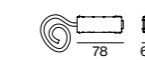
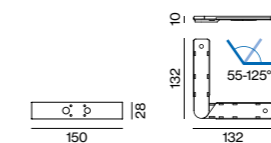
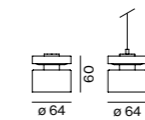
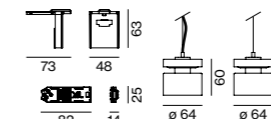
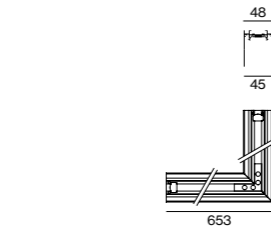

← back

**Order options**

**CONTROL**

non DIM	1
DALI-2	3

**MATERIAL COLOUR**

○ traffic white RAL 9016	7
● jet black RAL 9005	8

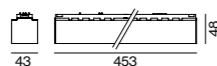

**Electrical accessories**

**POWER SUPPLY INTRACK** supply 220-240 V AC, 48 V, 50-60 Hz

TYPE	EFFICIENCY	MOUNTING	L-W-H (mm)	ORDER CODE
150W □ PC II η 92%		intrack	453-43-48	050-2071238
250W □ PC II η 93%		intrack	453-43-48	050-2071338

ENEC approved, incl. feeder cable 2000mm; DALI-2 SELV device integrated

**POWER SUPPLY SURFACE** supply 220-240 V AC, 48 V, 50-60 Hz

TYPE	EFFICIENCY	MOUNTING	L-W-H (mm)	ORDER CODE
60W □ PC II η 88%		surface	305-144-54	050-20551
100W □ PC II η 92%		surface	455-104-40	050-20554
150W □ PC II η 92%		surface	455-104-40	050-20552
250W □ PC II η 93%		surface	455-104-40	050-20555
320W ⊕ PC I η 94%		surface	305-144-54	050-20553

ENEC approved, incl. feeder cable 2000mm; DALI-2 SELV device integrated

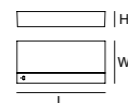

**POWER SUPPLY EXTERNAL** supply 220-240 V AC, 48 V, 50-60 Hz

TYPE	EFFICIENCY	MOUNTING	L-W-H (mm)	ORDER CODE
60W □ PC II η 88%		external	163-43-32	002-62133
100W □ PC II η 92%		external	350-30-18	002-62134
150W □ PC II η 92%		external	350-30-18	002-62135
250W □ PC II η 93%		external	400-40-22	002-62139
320W ⊕ PC I η 94%		external	252-90-44	002-60320

ENEC approved, incl. feeder cable 2000mm

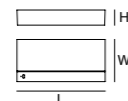

**DIN RAIL POWER SUPPLY BASIC 48V**

220-240V | 50-60Hz | □ PC II | MTBF @ 55° ambient temperature

TYPE	EFFICIENCY / MTBF	W-H-D (mm)	ORDER CODE
96W η 89% / >300.000h		90-90-60	005-6520010

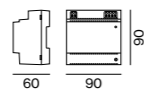

**DIN RAIL POWER SUPPLY PRO 48V**

220-240V | 50-60Hz | ⊕ PC I | MTBF @ 55° ambient temperature  
cascadable max. 5 devices (240 W) or 3 devices (480 W)

TYPE	EFFICIENCY / MTBF	W-H-D (mm)	ORDER CODE
240W η 92% / >400.000h		60-125-100	005-6220110
480W η 93% / >350.000h		120-125-100	005-6220210

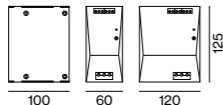

**DALI-2 SELV DEVICE**

TYPE	L-W-H (mm)	ORDER CODE
control unit	213-37-25	050-2061130

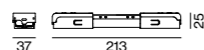

necessary to create DALI-2 SELV signal; DALI power supply integrated

**DALI-2 SENSOR**

TYPE	L-W-H (mm)	ORDER CODE
ESSENTIAL sensor (brightness & presence)	43-43-48	050-2063378
SENSE sensor (brightness, presence, temperature, sound pressure, humidity, CO <sub>2</sub> )	43-43-48	050-2063278

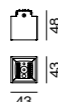

**WIRELESS TO DALI-2 CONTROL DEVICE**

TYPE	L-W-H (mm)	ORDER CODE
Zigbee 3.0	111-25-45	050-2065130
Casambi	111-25-45	050-2065230



**WIRELESS TO DALI-2 REPEATER**

TYPE	L-W-H (mm)	ORDER CODE
Zigbee 3.0	111-25-45	050-2066130
Casambi	111-25-45	050-2066230



DALI-2 SELV device required

**MIDDLE FEED**

TYPE	ORDER CODE
non DIM 2×2,5mm <sup>2</sup>	050-2038110
DALI-2 2×2,5 + 2×0,5mm <sup>2</sup>	050-2038130

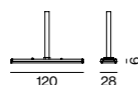

cable length 2000mm



← back



# LIGHT INSET 45

linear inset 45

## Quickinfo

3000K, 4000K, TW  
 CRI ≥ 90, 3 SDCM  
 DALI-2

L85 @ 50 000 h  
 opal / opal jut-out up to 99 lm/W  
 microprism. (≤ 19) up to 88 lm/W  
 microprism. (≤ 22) up to 78 lm/W

L80 @ 50 000 h  
 UGR ≤ 19 / 65° ≤ 1500 cd/m²  
 L1 up to 106 lm/W  
 L2 up to 97 lm/W  
 L4 up to 104 lm/W  
 L6 up to 90 lm/W

L90 @ 50 000 h  
 UGR ≤ 19 / 65° ≤ 1500 cd/m²  
 L10 office up to 102 lm/W  
 L24 office up to 120 lm/W

## Types

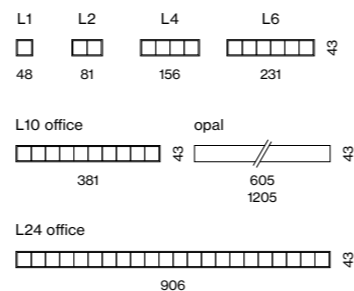

## Colour



## Light distributions

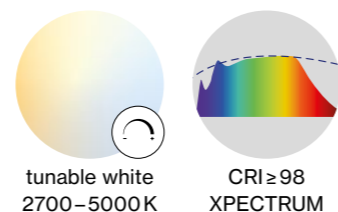

## Order options

COLOUR TEMPERATURE	
3000K	5
4000K	6
tunable white 2700–5000K*	D

\*DALI-2 DT8

## CONTROL

DALI-2

## MATERIAL COLOUR

● jet black RAL 9005

## Options on request

COLOUR RENDERING INDEX  
 CRI ≥ 98 XPECTRUM

## CONTROL

Zigbee 3.0

## LIGHT INSET 45

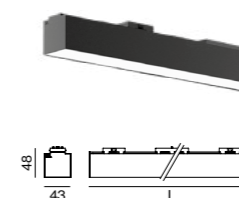

### OPAL HIGH PERFORMANCE

INSET POWER	COLOUR TEMP.	LUM. FLUX	L (mm)	ORDER CODE
12W	3000K	1120lm	605	0 5 0 - 3 2 1 2 :: 38H
24W	3000K	2240lm	1205	0 5 0 - 3 2 1 4 :: 38H
	4000K	1190lm		
	4000K	2380lm		

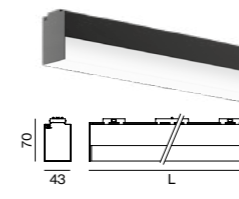

### OPAL JUT-OUT

INSET POWER	COLOUR TEMP.	LUM. FLUX	L (mm)	ORDER CODE
12W	3000K	1120lm	605	0 5 0 - 3 2 1 2 :: 38J
24W	3000K	2240lm	1205	0 5 0 - 3 2 1 4 :: 38J
	4000K	1190lm		
	4000K	2380lm		

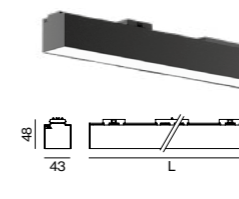

### MICROPRISMATIC UGR ≤ 19

INSET POWER	COLOUR TEMP.	LUM. FLUX	L (mm)	ORDER CODE
9.9W	3000K	704lm	605	0 5 0 - 3 2 1 2 :: 38P
17W	3000K	1410lm	1205	0 5 0 - 3 2 1 4 :: 38P
	4000K	751lm		
	4000K	1500lm		

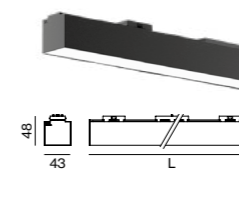

### MICROPRISMATIC UGR ≤ 22

INSET POWER	COLOUR TEMP.	LUM. FLUX	L (mm)	ORDER CODE
23W	3000K	1640lm	605	0 5 0 - 3 2 4 2 :: 38P
45W	3000K	3280lm	1205	0 5 0 - 3 2 4 4 :: 38P
	4000K	1750lm		
	4000K	3500lm		

INSET POWER in watts is the current consumption excluding any ballast  
 LUMINOUS FLUX value calculated for CRI ≥ 90, colour black

← back

**Order options**

**COLOUR TEMPERATURE**

3000K	5
4000K	6
tunable white 2700–5000K*	D

\*DALI-2 DT8

**CONTROL**  
DALI-2

**LIGHT OPTIC**

medium square (UGR≤10)	E
flood square (UGR≤19)	F

**LIGHT OPTIC COLOUR**

chrome reflector	0
black reflector*	B

\*not available for spot round, narrow medium round and wallwasher

**MATERIAL COLOUR**  
● jet black RAL 9005

**Options on request**

**LIGHT OPTIC**

spot round
narrow medium round
medium round (UGR≤19)
medium square (UGR≤10)
flood round (UGR≤19)
flood square (UGR≤19)
wide flood round
wide flood square
rectangular
wallwasher
wallwasher floor

**LIGHT OPTIC COLOUR**

gold reflector
----------------

**Planning information**

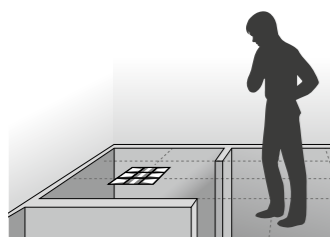

The icons of the light optics are shown in the reflected ceiling plan (RCP) view.

**INSET POWER** in watts is the current consumption excluding any ballast  
**LUMINOUS FLUX** value calculated for CRI≥90, colour black, reflector chrome

**L1 LIGHT INSET**

**FLOOR**

INSET POWER	COLOUR TEMP.	LUMINOUS FLUX	ORDER CODE
3.4 W	3000 K	up to 338 lm	0 90 - 9 L 1 :: 3 ▲ B ▣ 0 1
	4000 K	up to 361 lm	

choose one light optic ▲ from the options on the left depending on your room needs

**L2 LIGHT INSET**

**WALL**  
2 × wallwasher

INSET POWER	COLOUR TEMP.	LUMINOUS FLUX	ORDER CODE
6.9 W	3000 K	590 lm	0 90 - 9 L 2 :: 3 A B 0 0 1
	4000 K	633 lm	

**WALL FLOOR**  
2 × wallwasher floor

INSET POWER	COLOUR TEMP.	LUMINOUS FLUX	ORDER CODE
6.9 W	3000 K	620 lm	0 90 - 9 L 2 :: 3 W B ▣ 0 1
	4000 K	662 lm	

**CORRIDOR**  
2 × rectangular

INSET POWER	COLOUR TEMP.	LUMINOUS FLUX	ORDER CODE
6.9 W	3000 K	624 lm	0 90 - 9 L 2 :: 3 R B ▣ 0 1
	4000 K	667 lm	

**L4 LIGHT INSET**

**FLOOR/CORRIDOR**

INSET POWER	COLOUR TEMP.	LUMINOUS FLUX	ORDER CODE
14 W	3000 K	up to 1350 lm	0 90 - 9 L 4 :: 3 ▲ B ▣ 0 1
	4000 K	up to 1450 lm	

choose one light optic ▲ from the options on the left depending on your room needs

**WALL**  
4 × wallwasher

INSET POWER	COLOUR TEMP.	LUMINOUS FLUX	ORDER CODE
14 W	3000 K	1180 lm	0 90 - 9 L 4 :: 3 A B 0 0 1
	4000 K	1270 lm	

**WALL**  
2 × wallwasher 180° + 2 × wallwasher

INSET POWER	COLOUR TEMP.	LUMINOUS FLUX	ORDER CODE
14 W	3000 K	1180 lm	0 90 - 9 L 4 :: 3 A B 0 0 2
	4000 K	1270 lm	

**WALL FLOOR**  
4 × wallwasher floor

INSET POWER	COLOUR TEMP.	LUMINOUS FLUX	ORDER CODE
14 W	3000 K	1240 lm	0 90 - 9 L 4 :: 3 W B ▣ 0 1
	4000 K	1320 lm	

**WALL FLOOR**  
2 × wallwasher floor 180° + 2 × wallwasher floor

INSET POWER	COLOUR TEMP.	LUMINOUS FLUX	ORDER CODE
14 W	3000 K	1240 lm	0 90 - 9 L 4 :: 3 W B ▣ 0 2
	4000 K	1320 lm	

**Order options**

**COLOUR TEMPERATURE**

3000K	5
4000K	6
tunable white 2700–5000K*	D

\*DALI-2 DT8

**CONTROL**  
DALI-2

**LIGHT OPTIC COLOUR**

chrome reflector	0
black reflector*	B

\*not available for spot round, narrow medium round and wallwasher

**MATERIAL COLOUR**  
● jet black RAL 9005

**Options on request**

**COLOUR RENDERING INDEX**  
CRI ≥ 98 XPECTRUM\*  
\*only for L24 light inset

**LIGHT OPTIC**

spot round
narrow medium round
medium round (UGR≤19)
medium square (UGR≤10)
flood round (UGR≤19)
flood square (UGR≤19)
wide flood round
wide flood square
rectangular
wallwasher
wallwasher floor

**LIGHT OPTIC COLOUR**  
gold reflector

**INSET POWER** in watts is the current consumption excluding any ballast  
**LUMINOUS FLUX** value calculated for CRI≥90, colour black, reflector chrome

**L6 LIGHT INSET**

**WALL**  
6 × wallwasher

INSET POWER	COLOUR TEMP.	LUMINOUS FLUX	ORDER CODE
21 W	3000 K	1780 lm	0 90 - 9 L 6 :: 3 A B 0 0 1
	4000 K	1900 lm	

**L10 LIGHT INSET**

**OFFICE UGR≤19**  
10 × medium square

INSET POWER	COLOUR TEMP.	LUMINOUS FLUX	ORDER CODE
30 W	3000 K	2840 lm	0 50 - 3 2 1 1 :: 3 8 ▣ R
	4000 K	3060 lm	

**L24 LIGHT INSET**

**OFFICE UGR≤19**  
24 × medium square

INSET POWER	COLOUR TEMP.	LUMINOUS FLUX	ORDER CODE
21 W	3000 K	2350 lm	0 50 - 3 2 1 3 :: 3 8 R
	4000 K	2510 lm	

**SENAB**  
Stockholm, SE –  
by SENAB



**Tribünen der Trabrennbahn**  
Vienna, AT



**Press Glass Headquarters**  
Konopiska, PL – by Konior Studio,  
Tomasz Konior



**Langzauner GmbH** Ried im Innkreis, AT –  
by Architektur Mugrauer ZT GmbH with  
lighting design by planbox Interior Design GmbH

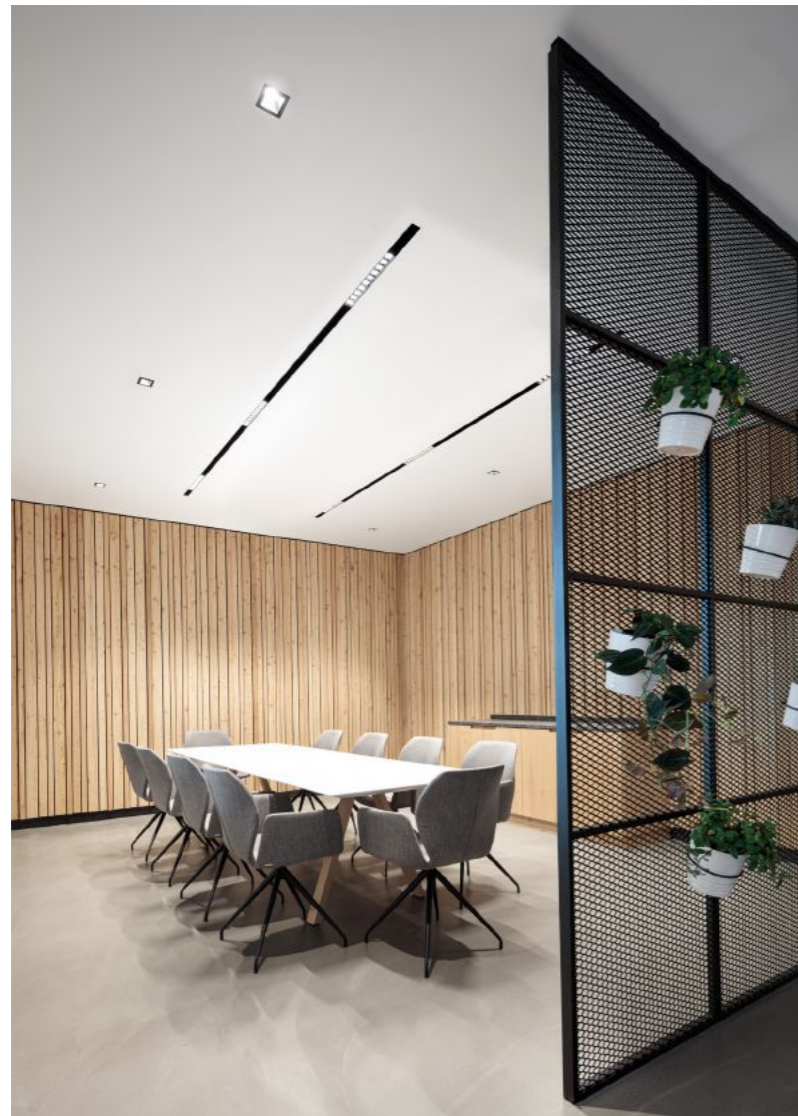



← back



# JUST 45/55

spotlight inset 45

## Quickinfo

2700K, 3000K, 4000K, CWD, TW  
CRI ≥ 90, 2 SDCM

non DIM, DALI-2

L80 @ 50 000 h  
JUST 45 up to 72lm/W

L90 @ 50 000 h  
JUST 55 up to 75lm/W

## Types

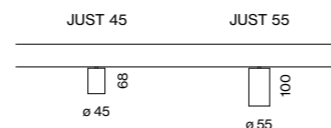

## Colours



## Light distributions

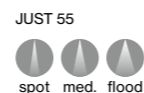
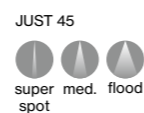

ARY rod  
p.734

ARY shade  
p.736

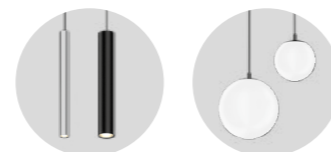

TULA  
p.742

PAL  
p.748

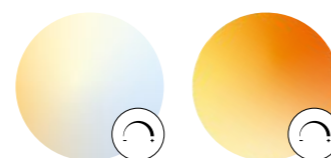

TW 1800-3000K  
or 2700-6500K

CWD  
2000-3000K

## Order options

COLOUR TEMPERATURE	
2700K	4
3000K	5
4000K	6
colour warm dim. 2000-3000K*	
tunable white 1800-3000K**	
tunable white 2700-6500K**	

\*DALI-2 \*\*DALI-2 DT8

CONTROL	
non DIM	1
DALI-2	3

MATERIAL COLOUR	
○ traffic white RAL 9016	7
● jet black RAL 9005	8
● special colours p.992	X

BEAM ANGLE JUST 45	
medium 23°	M
flood 44°	F

BEAM ANGLE JUST 55	
spot 16°	S
medium 28°	M
flood 37°	F

**INSET POWER** in watts is the current consumption excluding any ballast  
**LUMINOUS FLUX** value calculated for 3000K, CRI ≥ 90, colour white, lens flood 2700K -5%, 4000K +5%

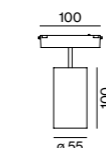
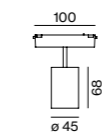

## JUST 45



### SPOTLIGHT

INSET POWER	LUMINOUS FLUX	ORDER CODE
6.1W super spot 8°	297lm	050-0131::3V
11W	788lm	050-0131::3V
12W CWD 2000-3000K	430lm	050-0131E3V
11W TW 1800-3000K	555lm	050-0131L3V
11W TW 2700-6500K	683lm	050-0131D3V

## JUST 55



### SPOTLIGHT

INSET POWER	LUMINOUS FLUX	ORDER CODE
15.9W	1300lm	050-0143::3V
30W	2090lm	050-0142::3V

## Optical accessories

### HONEYCOMB LOUVER

TYPE	Ø-H (mm)	ORDER CODE
JUST 45	42·3	007-1965188
JUST 55	50·3	007-1965598

**The Raum** Bolzano, IT –  
by bergundtal gmbh.



[←](#) back

### Quickinfo

PET felt  
 ♻️ from recycled material  
 up to absorption class A

### Type

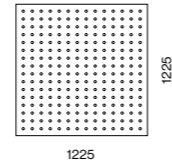

### Colours



### Order options

**MATERIAL COLOUR**  **W**  
 white  
 black **L**

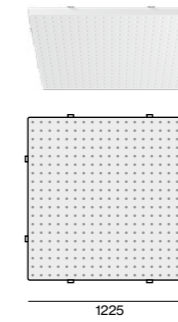

### MOVE IT 45 suspended

#### MOVE IT ACOUSTIC SQUARE

TYPE	L-W-H (mm)	ORDER CODE
1200 inlay MOVE IT system*	1225·1225·57	050-230222 <input checked="" type="checkbox"/>

\*NODE connector + track 1220mm

### ACOUSTIC EXAMPLES

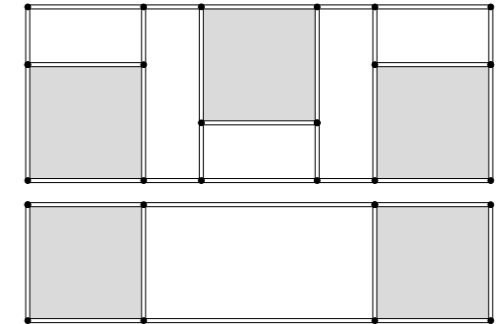

## ACOUSTIC elements

accessory 45

EN Highly effective acoustic element made of self-supporting, recycled PET felt; direct sound is absorbed by the front-mounted fleece, sound reflected from the ceiling by an additional, rear-mounted fleece; this creates high acoustic performance; for installation in the MOVE IT 45 suspended system composed of node connectors and 1220 mm profiles

IT Elemento acustico altamente efficiente in feltro prodotto con PET riciclato e autoportante; assorbimento del suono diretto grazie al tessuto non tessuto anteriore e assorbimento del suono riflesso dal soffitto mediante tessuto non tessuto aggiuntivo posto sul retro; con elevata performance acustica; per l'inserimento nel sistema a sospensione MOVE IT 45 con giunti di snodo e profili di 1220 mm di lunghezza disponibili

# Ultra-slim office series

## TASK system

**EN** In addition to impressive flexibility, the ultra-slim TASK series meets all requirements of modern office lighting. Innovative technology and highly efficient LEDs meet minimalistic design. Thanks to its microprismatic cover, TASK provides bright and glare-minimised work light. The product family with a shared sleek design is impressive: TASK can be expanded into a system via a click mechanism. The optional indirect light delivers pleasant ceiling illumination. Additional built-in sensors allow the TASK S system to adapt to motion and ambient brightness. The system can be expanded with optional acoustic elements to optimise room acoustics.

**IT** Oltre a sorprendere con la sua flessibilità, la serie di corpi illuminanti ultrasottili TASK soddisfa a pieno tutti i requisiti della moderna illuminazione per uffici. La tecnologia innovativa e l'efficienza dei LED si abbinano al design minimalista. La cover microprismatica diffonde una luce di lavoro brillante e con il minimo abbagliamento. La linea di prodotti convince in pieno per il suo design unitario e slanciato: TASK si può comporre in cluster servendosi di un meccanismo a innesto. Non manca l'opzione della luce diretta / indiretta per una piacevole luminosità sul soffitto. I modelli TASK S e la piantana integrano sensori di movimento e luminosità. Per migliorare l'acustica si possono inoltre aggiungere pannelli fonoassorbenti.

### Types

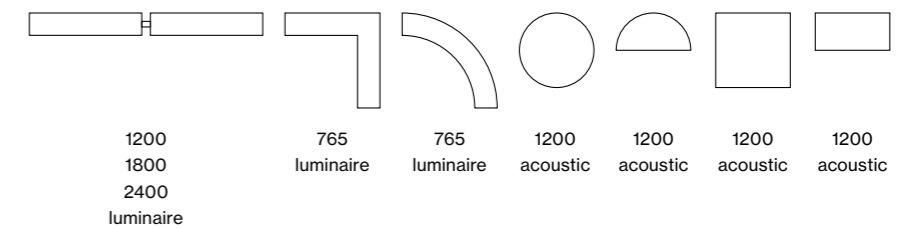

### Mounting

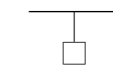

suspended

### Configurations

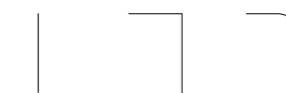

linear

corner

curve

### Light distributions

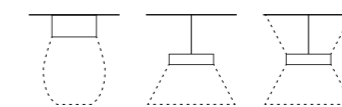

microprismatic  
(UGR ≤ 19)

direct

direct/indirect

## Ultra-slim and versatile

EN TASK combines an ultra-slim design with innovative lighting technology. These include, in particular, an LGP (Light Guiding Prism), which directs the laterally coupled light from highly efficient LEDs upwards and downwards. It creates a pleasant room atmosphere through a balanced relationship between direct and indirect light.

IT TASK combina design ultrasottile e illuminotecnica innovativa. In particolare il sistema LGP (Light Guiding Prism) guida in alto e in basso la luce degli efficientissimi LED inseriti lateralmente. Ne deriva una proporzione equilibrata di luce diretta e indiretta, a garanzia di un'atmosfera piacevole.

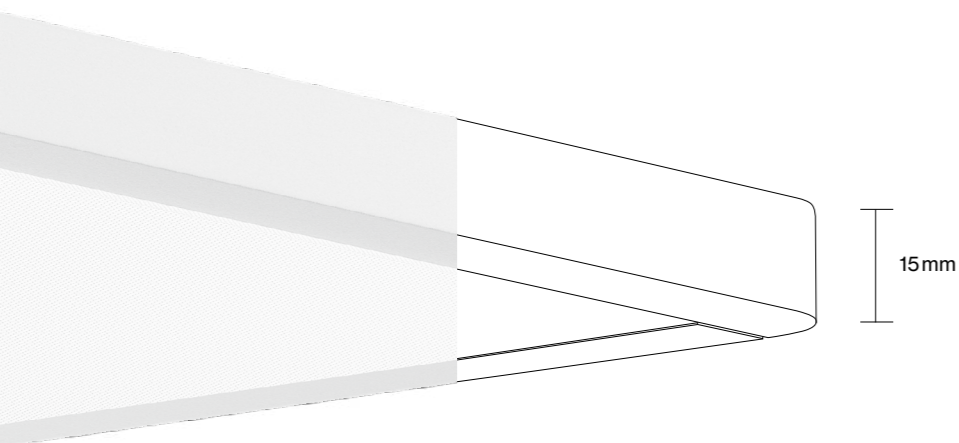

## Simple click

EN Design freedom thanks to plug-in connections. Each TASK S system luminaire can be rearranged, combined, and electrically connected with just one click and without any tools. Whether office extension or interior redesign, this lighting system can handle any change.

IT Libertà con semplici giunti: ogni apparecchio del sistema TASK S si fissa e si collega con un pratico innesto, senza bisogno di attrezzatura. Anche qualora si desideri ampliare l'ufficio o ridisegnarlo, il sistema d'illuminazione si adatta a ogni cambiamento.

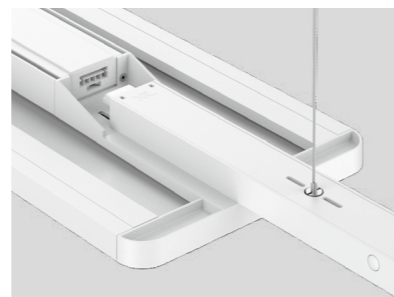

## Pleasant room acoustics

EN In addition to lighting, pleasant room acoustics have an impact on job satisfaction. Acoustic element panels in different colours and made of 60% recycled PET complement the TASK series and reduce background noise around the office. For focused, productive work.

IT Conta la luce ma non soltanto. Anche un'acustica gradevole è fondamentale per sentirsi a proprio agio mentre si lavora. La serie TASK offre pannelli acustici di diversi colori, ricavati al 60% da PET riciclato, che servono a ridurre i rimbombi in ufficio, favorendo quindi concentrazione e produttività.

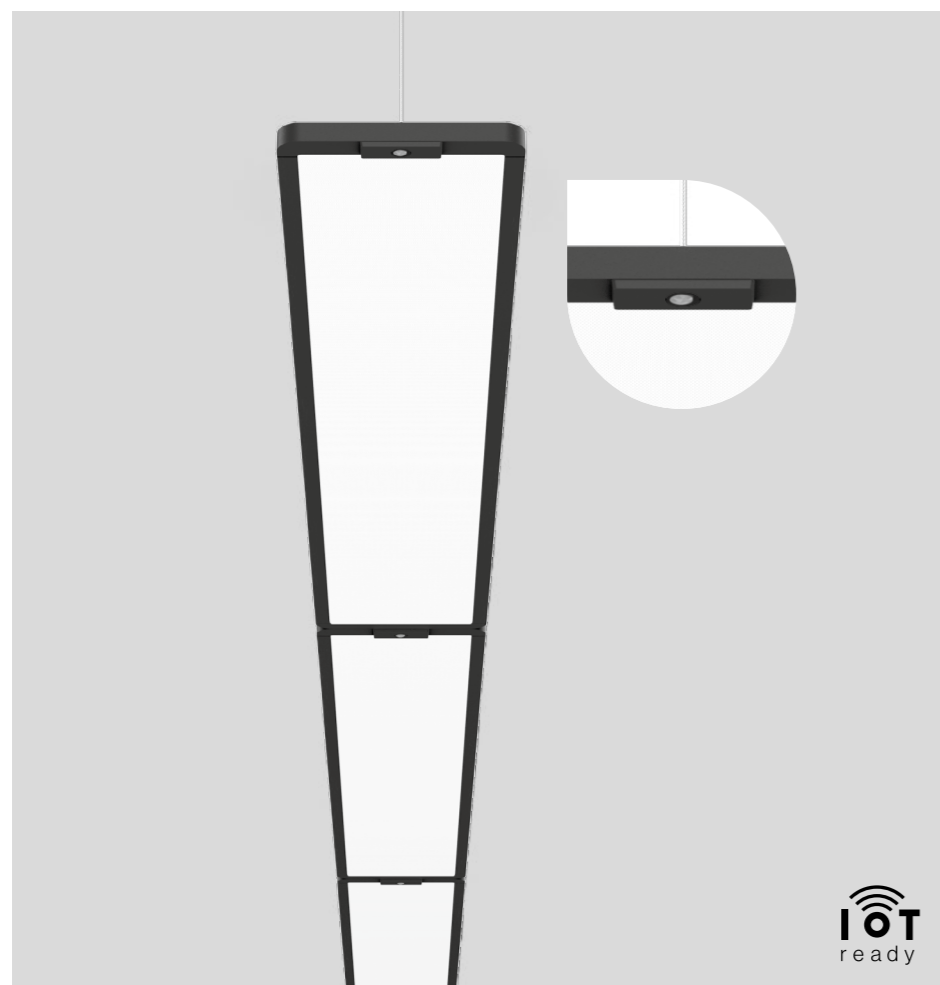

## Advanced sensor technology

EN The TASK S system luminaire adapts to daylight and room activity. Integrated motion sensors automatically dim the lighting when no one is in the room. Smart movement sensors enable the light intensity to be adjusted to the ambient brightness. This saves energy and creates a dynamic, natural lighting atmosphere.

IT Gli apparecchi TASK S in sistema si adattano alla luce del giorno e all'attività svolta. Integrano sensori di movimento che abbassano automaticamente l'illuminazione quando non è presente nessuno. Gli intelligenti sensori Daylight dosano inoltre l'intensità luminosa in funzione della luce esterna, risparmiando energia e creando uno scenario dinamicamente naturale.

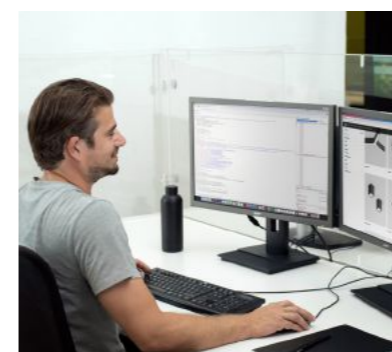

## Screen-work friendly

EN TASK guarantees standard-compliant illumination of workplaces with custom anti-glare prisms. An ideal light source for double workstations in open-plan offices and for single workstations in smaller offices – all with reduced reflections.

IT TASK possiede speciali prismi di schermatura che garantiscono un'illuminazione a norma dei posti di lavoro. Un sistema ideale per le doppie scrivanie degli open space ed anche per le singole postazioni in piccoli uffici, dove si riducono gli abbagliamenti riflessi.

## Full-spectrum LED

EN XAL's new XPECTRUM LEDs deliver healthy, biologically effective light. The reduced blue light and increased cyan values reduce the blue light hazard for the eye to daylight-equivalent levels. The resulting non-visual, so-called melanopic light effect, improves concentration and increases sleep quality. The excellent colour rendering of IES TM 30-15  $R_f=98$  and  $R_g=101$  further helps visual comfort.

IT Il nuovo XPECTRUM LED di XAL assicura una luce sana con efficacia biologica. Lo spettro riduce le componenti azzurre e aumenta invece il ciano, con il risultato di una luce simile a quella diurna in cui i rischi per gli occhi dell'azzurro sono contenuti al minimo. Ne consegue un effetto non visivo, chiamato anche melanopico, che favorisce la concentrazione e migliora la qualità del sonno. Inoltre l'eccellente resa cromatica IES TM 30-15  $R_f=98$  e  $R_g=101$  migliora il comfort visivo.

XPECTRUM LED

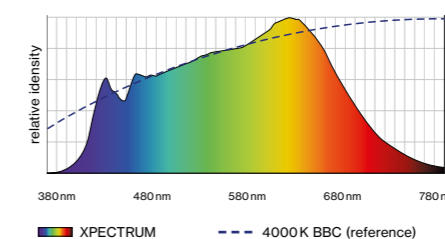

Commercially available LED 4000K

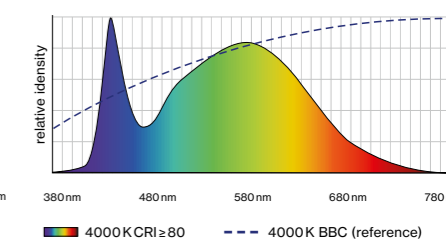

← back

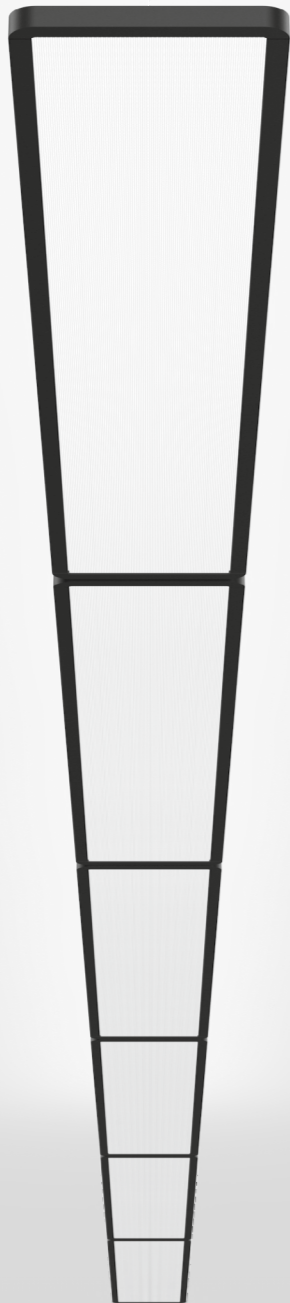

## TASK S system

suspended

EN Luminaire housing made of aluminium – rounded edges; rectangular, L-shaped or quarter circle segment design; ultra low-profile design (only 15 mm); for lighting systems; powder coated; cable suspension, tool-less height adjustment; convenient quick mounting system without tools; direct or direct/indirect light distribution by LGP body (Light Guiding Prism); side coupled light, directed downwards or up and down by laser engraving; light control via highly reflective reflector material; optional: indirect component – special PCBs for increased luminous flux (max. ceiling illumination); completely homogeneous illumination; energy-eff. LEDs – very good colour rendering; canopy for through wiring; sound absorb. accessories available

IT Corpo illuminante a sospensione di forma circolare, composto da singoli elementi in un quarto di cerchio o in una forma rettangolare; Corpo illuminante in alluminio – bordi arrotondati; forma ultrapiatta (solo 15 mm); verniciatura a polvere; cavo regolabile in altezza senza attrezzi; pratico sistema di montaggio rapido senza utensili; incl. cavo di alimentazione trasparente; distribuzione della luce diretta con sistema LGP-Body (Light Guiding Prism); luce convogliata lateralmente e direzionata in basso tramite incisione laser; percentuale indiretta con piastre a flusso luminoso potenziato e massima illuminazione del soffitto; illuminazione assolutamente omogenea; LED a risp. energ. – ottima resa cromatica; rosone per cablaggio passante; in opzione elementi acustici disponibile

### Quickinfo

3000K, 4000K, TW  
 CRI ≥ 90, 3 SDCM  
 UGR ≤ 19 / 65° ≤ 3000 cd/m²  
 up to 124 lm/W  
 L80 @ 50 000 h  
 DALI-2, DALI sensor  
 microprismatic (UGR ≤ 19)

### Types

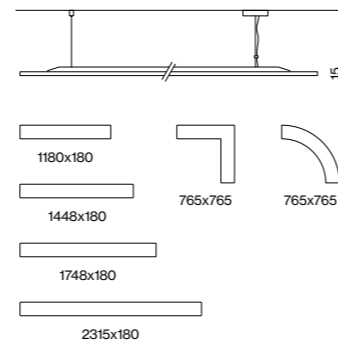

### Colours



### Light distributions

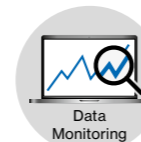
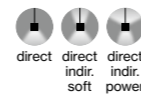

DiiA® standards  
251, 252, 253



single luminaire  
(p. 432)



acoustic  
elements (p. 456)



DIN EN 12464-1  
UGR ≤ 19



click-  
system



system  
connector

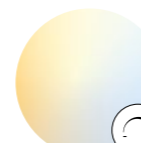

tunable white  
2700–6500 K

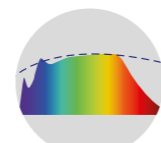

CRI ≥ 98  
XPECTRUM

### Order options

COLOUR TEMPERATURE	
3000 K	0
4000 K	1
tunable white 2700–6500 K*	

\*DALI-2 DT8; CRI ≥ 80

3000 K + TW 2700–6500 K	
4000 K + TW 2700–6500 K	
DALI-2 DT8 (separately controllable)	

CONTROL	
DALI-2	3
DALI sensor*	7

\*version with sensor: length + 9 mm

MATERIAL COLOUR	
○ pure white RAL 9010	7
● jet black RAL 9005	8

### Options on request

COLOUR RENDERING INDEX	
CRI ≥ 80	
CRI ≥ 98 XPECTRUM	

### Light distributions

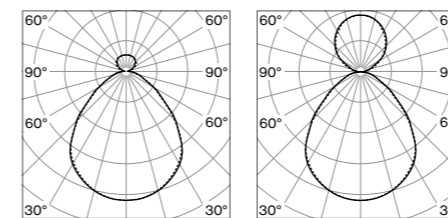

microprismatic  
direct/indirect soft

microprismatic  
direct/indirect power

LUMINOUS FLUX value calculated for  
 CRI ≥ 90, colour white, cover microprismatic

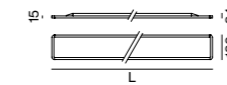

### TASK S LINEAR suspended



DIRECT					
SYS. POWER	COLOUR TEMP.	LUM. FLUX	L (mm)	ORDER CODE	
12.9 W	3000 K	1460 lm	1180	0 5 9 - 5 7 4 4 :: ◆ ◆ K	
	4000 K	1550 lm			
16.1 W	3000 K	1820 lm	1448	0 5 9 - 5 7 4 5 :: ◆ ◆ K	
	4000 K	1940 lm			
19.3 W	3000 K	2190 lm	1748	0 5 9 - 5 7 4 6 :: ◆ ◆ K	
	4000 K	2330 lm			
25.7 W	3000 K	2920 lm	2315	0 5 9 - 5 7 4 8 :: ◆ ◆ K	
	4000 K	3110 lm			



DIRECT / INDIRECT SOFT					
SYS. POWER	COLOUR TEMP.	LUM. FLUX	L (mm)	ORDER CODE	
19.5 W	3000 K	↓ 1900 / ± 327 lm	1180	0 5 9 - 5 7 5 4 :: ◆ ◆ K	
	4000 K	↓ 2020 / ± 347 lm			
24.4 W	3000 K	↓ 2380 / ± 408 lm	1448	0 5 9 - 5 7 5 5 :: ◆ ◆ K	
	4000 K	↓ 2540 / ± 435 lm			
29.2 W	3000 K	↓ 2860 / ± 490 lm	1748	0 5 9 - 5 7 5 6 :: ◆ ◆ K	
	4000 K	↓ 3040 / ± 521 lm			
39 W	3000 K	↓ 3810 / ± 653 lm	2315	0 5 9 - 5 7 5 8 :: ◆ ◆ K	
	4000 K	↓ 4050 / ± 695 lm			



DIRECT / INDIRECT POWER					
SYS. POWER	COLOUR TEMP.	LUM. FLUX	L (mm)	ORDER CODE	
42 W	3000 K	↓ 3190 / ± 1680 lm	1180	0 5 9 - 5 7 6 4 :: ◆ ◆ K	
	4000 K	↓ 3400 / ± 1790 lm			
49 W	3000 K	↓ 3190 lm	1180	0 5 9 - 5 7 D 4 0 ◆ ◆ K	
(2 × DALI)	2700–6500 K	± 2090 lm			
49 W	4000 K	↓ 3400 lm	1180	0 5 9 - 5 7 D 4 1 ◆ ◆ K	
(2 × DALI)	2700–6500 K	± 2090 lm			
62 W (2 ×)	2700–6500 K	± 6060 lm	1180	0 5 9 - 5 7 6 4 D ◆ ◆ K	

53 W	3000 K	↓ 3990 / ± 2100 lm	1448	0 5 9 - 5 7 6 5 :: ◆ ◆ K	
	4000 K	↓ 4250 / ± 2230 lm			
61 W	3000 K	↓ 3990 lm	1448	0 5 9 - 5 7 D 5 0 ◆ ◆ K	
(2 × DALI)	2700–6500 K	± 2610 lm			
61 W	4000 K	↓ 4250 lm	1448	0 5 9 - 5 7 D 5 1 ◆ ◆ K	
(2 × DALI)	2700–6500 K	± 2610 lm			
78 W (2 ×)	2700–6500 K	± 7570 lm	1448	0 5 9 - 5 7 6 5 D ◆ ◆ K	

63 W	3000 K	↓ 4790 / ± 2520 lm	1748	0 5 9 - 5 7 6 6 :: ◆ ◆ K	
	4000 K	↓ 5100 / ± 2680 lm			
71 W	3000 K	↓ 4790 lm	1748	0 5 9 - 5 7 D 6 0 ◆ ◆ K	
(2 × DALI)	2700–6500 K	± 2940 lm			
71 W	4000 K	↓ 5100 lm	1748	0 5 9 - 5 7 D 6 1 ◆ ◆ K	
(2 × DALI)	2700–6500 K	± 2940 lm			
85 W (2 ×)	2700–6500 K	± 8530 lm	1748	0 5 9 - 5 7 6 6 D ◆ ◆ K	

84 W	3000 K	↓ 6390 / ± 3360 lm	2315	0 5 9 - 5 7 6 8 :: ◆ ◆ K	
	4000 K	↓ 6800 / ± 3580 lm			
92 W	3000 K	↓ 6390 lm	2315	0 5 9 - 5 7 D 8 0 ◆ ◆ K	
(2 × DALI)	2700–6500 K	± 4180 lm			
92 W	4000 K	↓ 6800 lm	2315	0 5 9 - 5 7 D 8 1 ◆ ◆ K	
(2 × DALI)	2700–6500 K	± 4180 lm			
118 W (2 ×)	2700–6500 K	± 12120 lm	2315	0 5 9 - 5 7 6 8 D ◆ ◆ K	

### Mounting accessories

see page 814

**Order options**

**CORNER** ⚡

without power feeder	2
with power feeder	3

**COLOUR TEMPERATURE** ⚡

3000K	0
4000K	1

**CONTROL**

DALI-2	
--------	--

**MATERIAL COLOUR**

○ pure white RAL 9010	7
● jet black RAL 9005	8

**Options on request**

**COLOUR RENDERING INDEX**

CRI ≥ 80
CRI ≥ 98 XPECTRUM

**TASK S CORNER/CURVE suspended**

incl. cable suspension 1500 mm

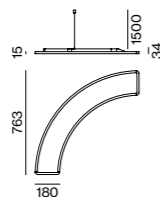
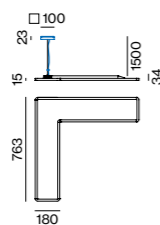

	CRI ≥ 98	UGR ≤ 19	cd/m² ≤ 3000	RG0 IEC 62471	BALD 1ADDR.	220-240V	X-PERT	X-PERT
--	----------	----------	--------------	---------------	-------------	----------	--------	--------

**DIRECT**

SYS. POWER	COLOUR TEMP.	LUM. FLUX	L (mm)	ORDER CODE
15W	3000K	1700lm	765	0 5 9 - 5 8 4 ⚡ :: 3 ⚡ K
corner	4000K	1810lm		

12.9W	3000K	1460lm	765	0 5 9 - 5 5 4 2 :: 3 ⚡ K
curve	4000K	1550lm		

	CRI ≥ 98	UGR ≤ 19	cd/m² ≤ 3000	RG0 IEC 62471	BALD 1ADDR.	220-240V	X-PERT	X-PERT
--	----------	----------	--------------	---------------	-------------	----------	--------	--------

**DIRECT / INDIRECT SOFT**

SYS. POWER	COLOUR TEMP.	LUM. FLUX	L (mm)	ORDER CODE
22.7W	3000K	↓ 2220 / ↑ 381lm	765	0 5 9 - 5 8 5 ⚡ :: 3 ⚡ K
corner	4000K	↓ 2370 / ↑ 407lm		

	CRI ≥ 98	UGR ≤ 19	RG0 IEC 62471	BALD 1ADDR.	220-240V	X-PERT	X-PERT
--	----------	----------	---------------	-------------	----------	--------	--------

**DIRECT / INDIRECT POWER**

SYS. POWER	COLOUR TEMP.	LUM. FLUX	L (mm)	ORDER CODE
49W	3000K	↓ 3680 / ↑ 1890lm	765	0 5 9 - 5 8 6 ⚡ :: 3 ⚡ K
corner	4000K	↓ 3920 / ↑ 2010lm		

42W	3000K	↓ 3150 / ↑ 1610lm	765	0 5 9 - 5 5 6 2 :: 3 ⚡ K
curve	4000K	↓ 3350 / ↑ 1720lm		

**Mounting accessories**

**LINEAR / CORNER 90° CONNECTOR** incl. cable suspension 1500 mm

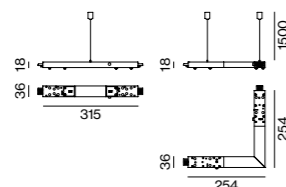

TYPE	L (mm)	ORDER CODE
linear mechanical & electrical	10	0 5 9 - 2 7 9 2 3 1 ⚡
linear mechanical	10	0 5 9 - 2 7 9 2 4 1 ⚡
corner 90° mechanical & electrical	254x254	0 5 9 - 2 7 9 2 7 1 ⚡
corner 90° mechanical	254x254	0 5 9 - 2 7 9 2 8 1 ⚡

**SYSTEM CONNECTOR** incl. cable suspension 1500 mm

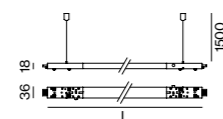

TYPE	L (mm)	ORDER CODE
mechanical & electrical	800	0 5 9 - 2 7 9 2 3 2 ⚡
mechanical & electrical	1200	0 5 9 - 2 7 9 2 3 3 ⚡
mechanical & electrical cuttable	1200	0 5 9 - 2 7 9 2 3 0 ⚡
mechanical & electrical cuttable	2400	0 5 9 - 2 7 9 2 3 4 ⚡
optional cable suspension	1500	0 5 9 - 2 7 9 2 1 2 7

**END PIECE** incl. cable suspension 1500 mm

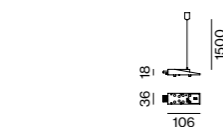

TYPE	L (mm)	ORDER CODE
end piece	1500	0 5 9 - 2 7 9 2 1 1 ⚡

**POWER FEEDER** incl. cable suspension 1500 mm and canopy / feeder cable

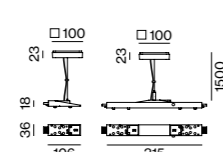

TYPE	L (mm)	ORDER CODE
power feeder 5x1.5mm²	1500	0 5 9 - 2 7 9 2 2 1 ⚡
middle power feeder 5x1.5mm²	1500	0 5 9 - 2 7 9 2 5 1 ⚡

for electrical system configuration see luminaire data sheet at xal.com

**Light distributions**

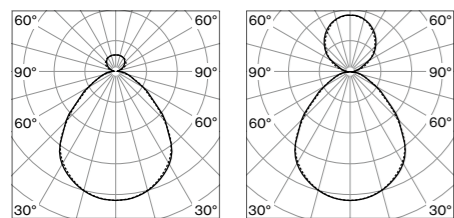

microprismatic direct/indirect soft      microprismatic direct/indirect power

**LUMINOUS FLUX** value calculated for colour white, cover microprismatic



L'Oréal Vienna, AT - by Philipp Grem

**Clariant Lodz, PL** –  
by The Design Group  
with lighting design  
by Plus Lighting





**Training center GBU Ritual**  
Moscow, RU – by Khvorostyaniy T. &  
Semionov A. with lighting design by  
KA2 Light Architecture



← back

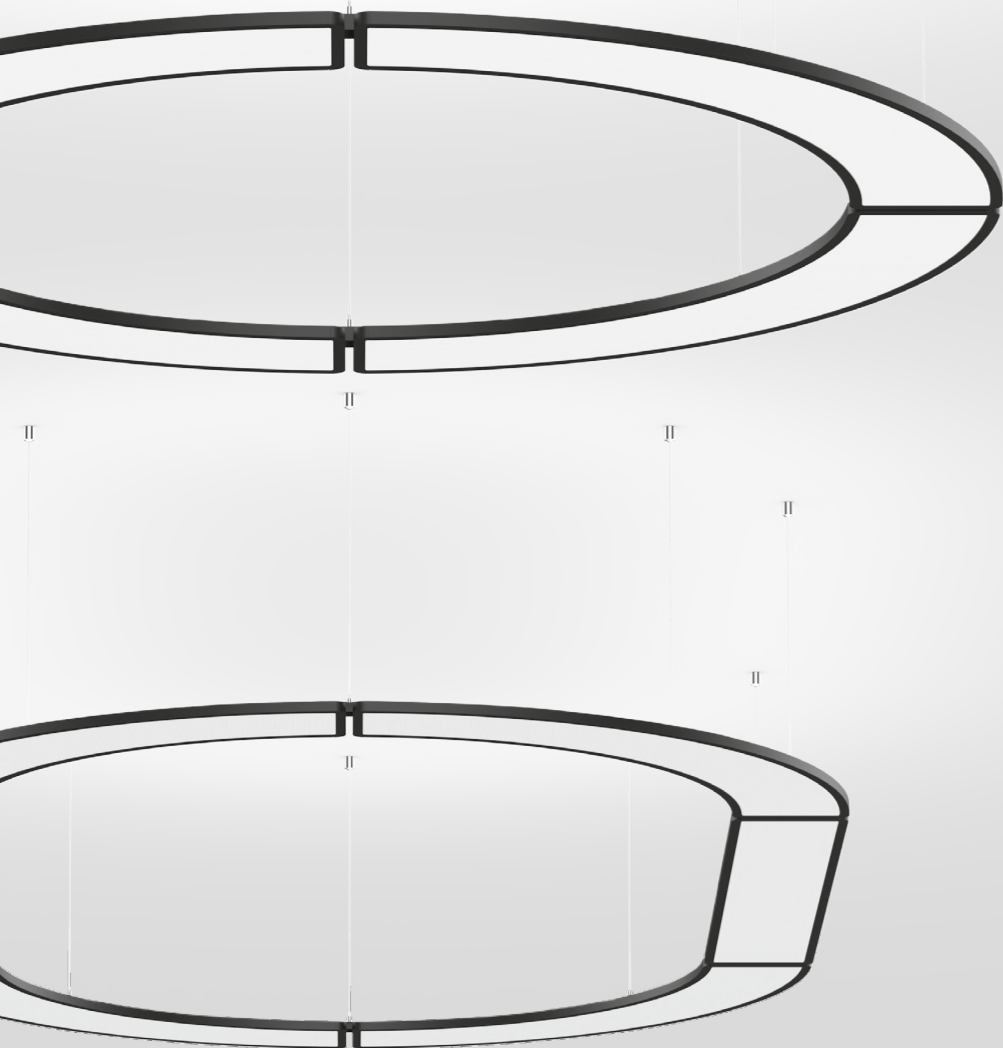

## TASK circle

suspended

Ring-shaped suspended luminaire, consisting of single elements in quarter circle or rectangular shape; Luminaire housing made of aluminium – rounded edges; ultra low-profile design (only 15 mm); surface powder coated; cable suspension, tool-less height adjustment; convenient quick mounting system without tools; incl. transparent feed; direct light distribution by LGP body (Light Guiding Prism); side coupled light directed downwards by laser engraving; indirect component with special PCBs for increased luminous flux and maximum ceiling illumination; completely homogeneous illumination; energy-eff. LEDs – very good colour rendering; canopy for through wiring; optional acoustic elements available

Corpo illuminante a sospensione di forma circolare, composto da singoli elementi in un quarto di cerchio o in una forma rettangolare; Corpo illuminante in alluminio – bordi arrotondati; forma ultrapiatta (solo 15 mm); verniciatura a polvere; cavo regolabile in altezza senza attrezzi; pratico sistema di montaggio rapido senza utensili; incl. cavo di alimentazione trasparente; distribuzione della luce diretta con sistema LGP-Body (Light Guiding Prism); luce convogliata lateralmente e direzionata in basso tramite incisione laser; percentuale indiretta con piastre a flusso luminoso potenziato e massima illuminazione del soffitto; illuminazione assolutamente omogenea; LED a risp. energ. – ottima resa cromatica; rosone per cablaggio passante; in opzione elementi acustici disponibile



### Quickinfo

4000K  
CRI ≥ 90, 3 SDCM  
UGR ≤ 19 / 65° ≤ 3000 cd/m<sup>2</sup>  
up to 117 lm/W  
L95 @ 50 000 h  
DALI-2  
microprismatic (UGR ≤ 19)

acoustic elements  
PET felt  
from recycled material  
up to absorption class A  
available as B-s1, d0

### Types

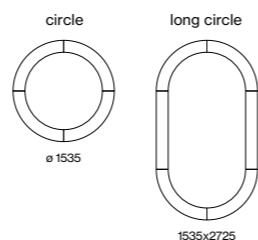

### Luminaire colours



### Acoustic colours

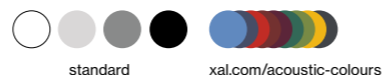

### Light distribution

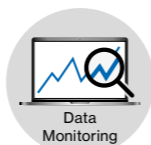

DiiA® standards  
251, 252, 253



click-system

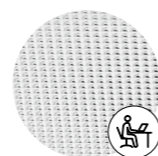

DIN EN 12464-1  
UGR ≤ 19

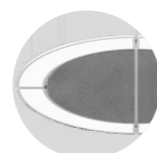

acoustic elements

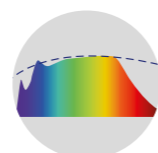

CRI ≥ 98  
XPECTRUM

### Order options

#### COLOUR TEMPERATURE

4000K

#### CONTROL

DALI-2

#### LUMINAIRE COLOUR

○ pure white RAL 9010 7  
● jet black RAL 9005 8

#### ACOUSTIC COLOUR

○ white W  
● marble grey D  
● felt grey G  
● black L  
● special colours p. 992 X

#### LIGHT OPTIC COVER

microprismatic (UGR ≤ 19)

### Options on request

#### COLOUR RENDERING INDEX

CRI ≥ 80  
CRI ≥ 98 XPECTRUM

#### FORM

for other configurations see  
TASK S suspended system

### Light distribution

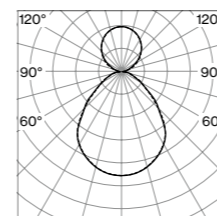

microprismatic  
direct/indirect power

LUMINOUS FLUX value calculated for  
CRI ≥ 90, colour white, cover microprismatic

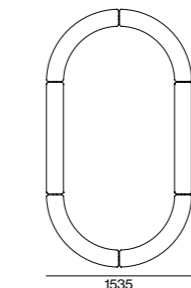
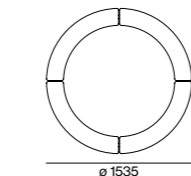
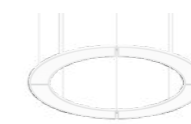

### TASK circle suspended



#### DIRECT / INDIRECT POWER

SYSTEM POWER	COLOUR TEMP.	LUMINOUS FLUX	ORDER CODE
169W	4000K	↓ 12900 / ± 6870 lm	0 5 9 - 5 2 8 1 1 3 K

### TASK long circle suspended



#### DIRECT / INDIRECT POWER

SYSTEM POWER	COLOUR TEMP.	LUMINOUS FLUX	ORDER CODE
252W	4000K	↓ 20200 / ± 10460 lm	0 5 9 - 5 2 8 2 1 3 K

### Technical data

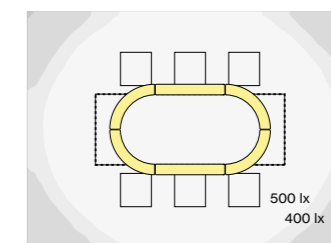

TASK long circle  
252W, 4000K, direct/indirect power

**ROOM VALUES**  
Room dimensions 5.4 × 4 × 2.8 m  
Reflection factor 0.7 | 0.5 | 0.2  
Maintenance factor 0.8  
Suspension height 2.25 m

**CALCULATION SURFACE** .....  
Surface dimensions 3.2 × 1.2 m  
Surface height 0.75 m  
Average illuminance (E<sub>m</sub>) > 500 lx  
Uniformity (U<sub>0</sub>) > 0.6

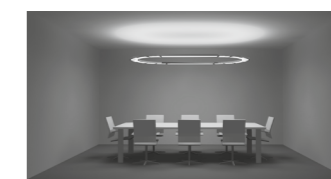

**GLARE EVALUATION**  
Table Classification X=4H | Y=8H | S=0.25H  
UGR transversal ≤ 19  
UGR axial ≤ 19

### Acoustic elements

#### TASK ACOUSTIC inlay

TYPE	L-W-H (mm)	ORDER CODE
1 TASK circle suspended	1155-1155-30	0 5 9 - 5 7 9 7 3 6 K
2 TASK long circle suspended	1155-2346-30	0 5 9 - 5 7 9 7 3 8 K

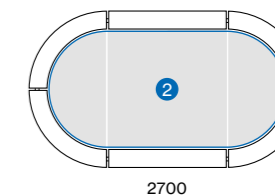
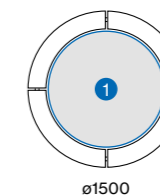



Art Invest Millenium Tower  
Vienna, AT –  
by LOVE architecture and urbanism

ART INVEST  
REAL ESTATE

**Compound Semiconductor  
Applications Catapult**  
Wales, UK – by Monteith Scott



← back

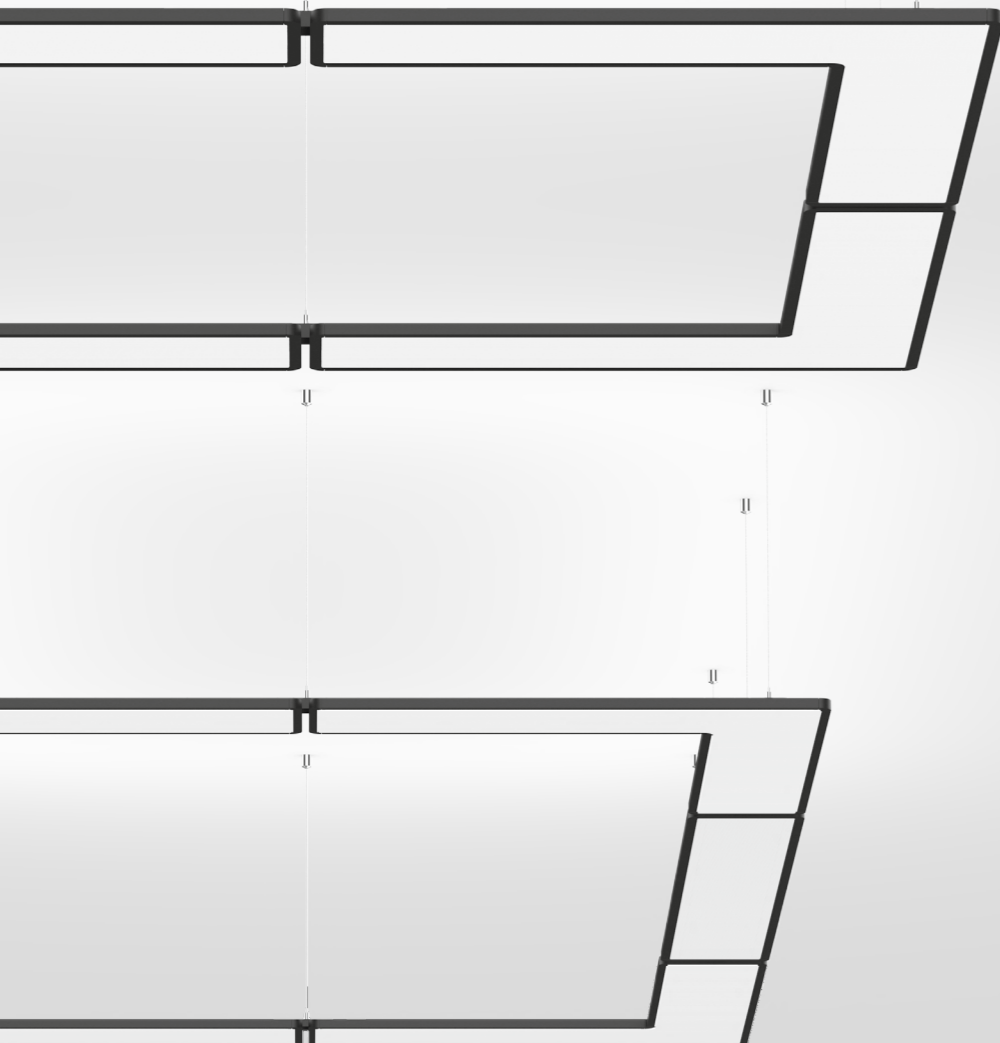

## TASK angular suspended

Rectangular suspended luminaire, consisting of single L-shaped or rectangular elements; Luminaire housing made of aluminium – rounded edges; ultra low-profile design (only 15 mm); surface powder coated; cable suspension, tool-less height adjustment; convenient quick mounting system without tools; incl. transparent feed; direct light distribution by LGP body (Light Guiding Prism); side coupled light directed downwards by laser engraving; indirect component with special PCBs for increased luminous flux and maximum ceiling illumination; completely homogeneous illumination; energy-eff. LEDs – very good colour rendering; canopy for through wiring; optional acoustic elements available

Corpo illuminante a sospensione di forma rettangolare, composto da singoli elementi a L o rettangolari; Corpo illuminante in alluminio – bordi arrotondati; forma ultrapiatta (solo 15 mm); verniciatura a polvere; cavo regolabile in altezza senza attrezzi; pratico sistema di montaggio rapido senza utensili; incl. cavo di alimentazione trasparente; distribuzione della luce diretta con sistema LGP-Body (Light Guiding Prism); luce convogliata lateralmente e direzionata in basso tramite incisione laser; percentuale indiretta con piastre a flusso luminoso potenziato e massima illuminazione del soffitto; illuminazione assolutamente omogenea; LED a risp. energ. – ottima resa cromatica; rosone per cablaggio passante; in opzione elementi acustici disponibile

### Quickinfo

4000K  
CRI ≥ 90, 3 SDCM  
up to 118lm/W  
L95 @ 50 000h  
DALI-2  
microprismatic (UGR ≤ 19)

acoustic elements  
PET felt  
from recycled material  
up to absorption class A  
available as B-s1, d0

### Types

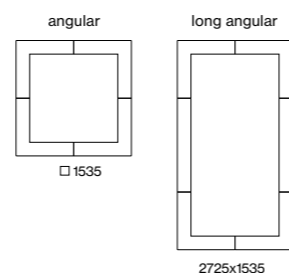

### Luminaire colours



### Acoustic colours

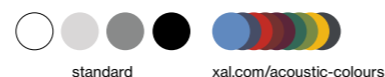

### Light distribution

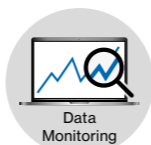

DiiA® standards  
251, 252, 253

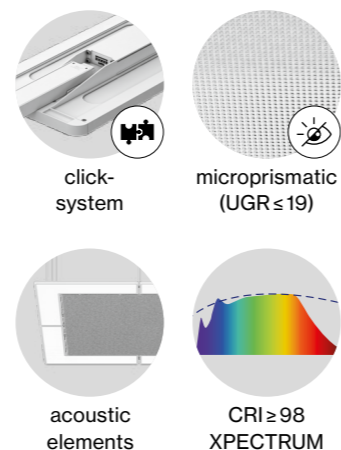

### Order options

COLOUR TEMPERATURE  
4000K

CONTROL  
DALI-2

LUMINAIRE COLOUR  
pure white RAL 9010 7  
jet black RAL 9005 8

ACOUSTIC COLOUR  
white W  
marble grey D  
felt grey G  
black L  
special colours p.992 X

LIGHT OPTIC COVER  
microprismatic (UGR ≤ 19)

### Options on request

COLOUR RENDERING INDEX  
CRI ≥ 80  
CRI ≥ 98 XPECTRUM

### FORM

for other configurations see  
TASK S suspended system

### Light distribution

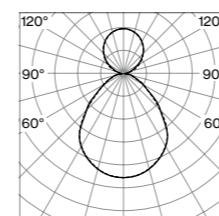

microprismatic  
direct/indirect power

LUMINOUS FLUX value calculated for  
CRI ≥ 90, colour white, cover microprismatic

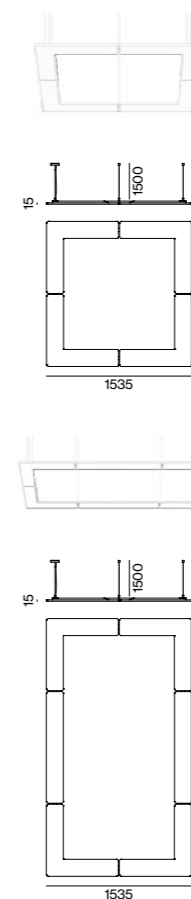

### TASK angular suspended



#### DIRECT / INDIRECT POWER

SYSTEM POWER	COLOUR TEMP.	LUMINOUS FLUX	ORDER CODE
197W	4000K	↓ 15200/± 8050 lm	0 5 9 - 5 2 8 3 1 3 K

### TASK long angular suspended



#### DIRECT / INDIRECT POWER

SYSTEM POWER	COLOUR TEMP.	LUMINOUS FLUX	ORDER CODE
280W	4000K	↓ 22480/± 11620 lm	0 5 9 - 5 2 8 4 1 3 K

### Technical data

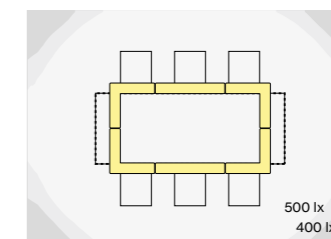

TASK long angular, 280W, 4000K,  
direct/indirect power

ROOM VALUES

Room dimensions	5.4 × 4 × 2.8m
Reflection factor	0.7   0.5   0.2
Maintenance factor	0.8
Suspension height	2.25m

CALCULATION SURFACE

Surface dimensions	3.2 × 1.2m
Surface height	0.75m
Average illuminance (E <sub>m</sub> )	> 500 lx
Uniformity (U <sub>0</sub> )	> 0.6

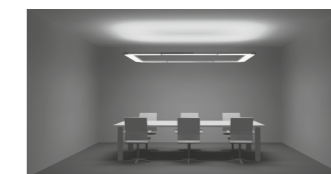

GLARE EVALUATION

Table Classification X=4H   Y=8H   S=0.25H	
UGR transversal	≤ 19
UGR axial	≤ 19

### Acoustic elements

#### TASK ACOUSTIC inlay

TYPE	L-W-H (mm)	ORDER CODE
1 TASK angular suspended	1155-1155-30	0 5 9 - 5 7 9 7 1 6 K
2 TASK long angular suspended	1155-2346-30	0 5 9 - 5 7 9 7 1 8 K

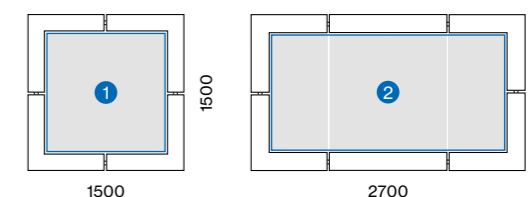

**L'Oréal**  
Vienna, AT –  
by Philipp Grem



**Community Windpower**  
Cheshire, UK



**Training center GBU Ritual**  
Moscow, RU – by Khvorostyaniy T. &  
Semionov A. with lighting design by  
KA2 Light Architecture

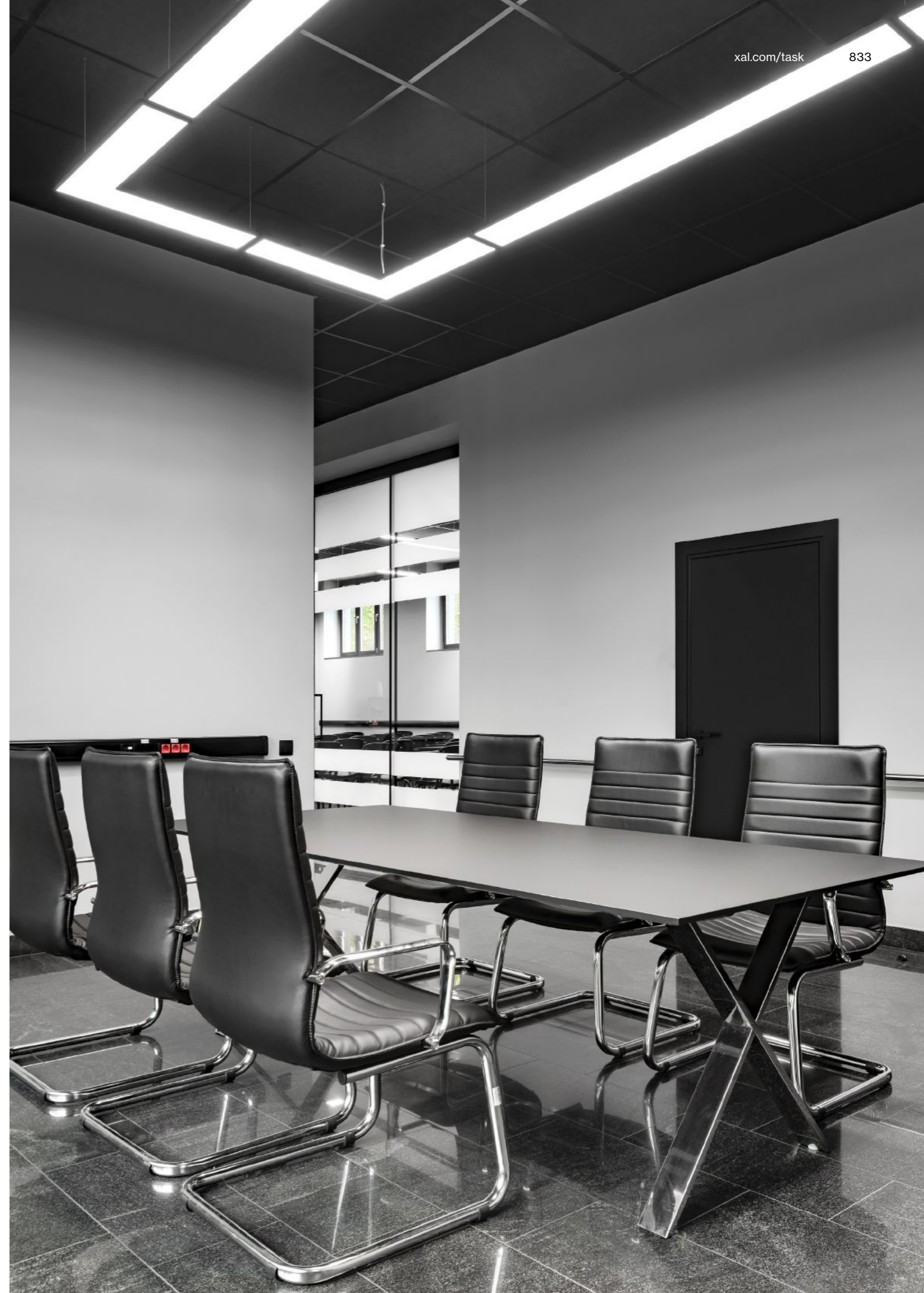



# Slim and smart office system

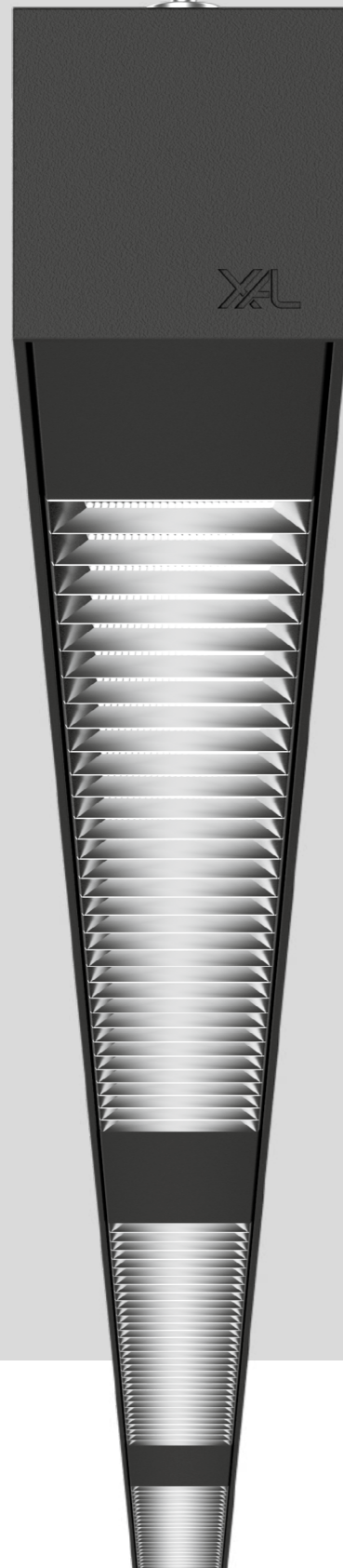

## BETO system

**EN** BETO is extremely slim, powerful, and optimised for office use. It is a system luminaire with an impressive range of flexible elements that can be lined up like building blocks. Available in ceiling-mounted and suspended versions, the system combines technical excellence with subtle, minimalist design. Designed specifically for offices, BETO has custom reflectors to give the best possible user-friendly, ambient monitor lighting. Some variants can be fitted with a brightness and presence sensor. This adapts the lighting to the activity in the office while reducing energy costs. The BETO System has an optional indirect light component for additional ceiling illumination. All curved and straight elements come in 3000 K or 4000 K light colours, and some also have a Tunable White option.

**IT** Ultrasottile ma potente, ottimizzato per gli uffici: il sistema BETO convince in pieno per i suoi elementi flessibili che si allineano con un principio modulare. Sia il modello a plafone che quello a sospensione uniscono l'eccellenza tecnica a un design minimalista. BETO è concepito specificamente per il lavoro in ufficio e per questo possiede un riflettore speciale adatto alle postazioni al computer. Inoltre si può scegliere il modello con sensore di movimento e luminosità: in tal caso l'illuminazione si adatta dinamicamente al contesto e allo stesso tempo si riducono i consumi energetici. Un'altra opzione è la componente di luce indiretta proiettata sul soffitto. Tutte le unità luminose, lineari e curve, sono disponibili in temperatura di colore 3000K, 4000K oppure con l'opzione Tunable White.

### Types

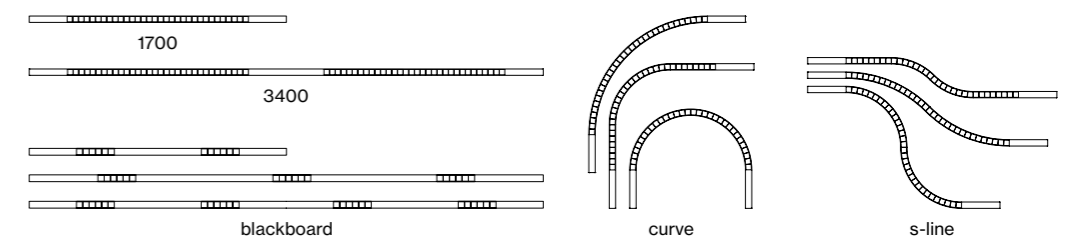

### Mountings

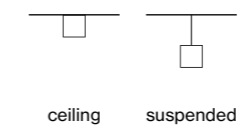

### Light distributions

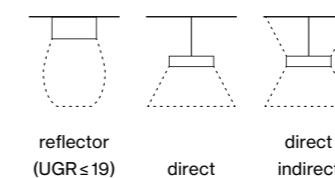

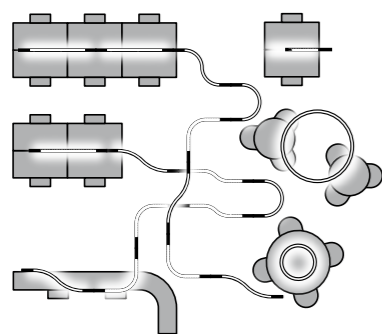

## Straight or curved

EN BETO System comes as a suspended luminaire with both straight or curved system elements. Regardless of whether in a linear, curved, or s-shaped design, BETO offers a multifunctional lighting solution that can be integrated into any lighting concept. With an optional indirect light component, the light is distributed homogeneously, creating a pleasant atmosphere.

IT BETO System è disponibile come apparecchio a sospensione con moduli lineari, curvi e ondulati, tutti ideali per una soluzione multifunzionale in grado di soddisfare ogni progetto illuminotecnico. In opzione si può aggiungere una componente di luce indiretta che si distribuisce nell'ambiente con uniformità creando un'atmosfera accogliente.

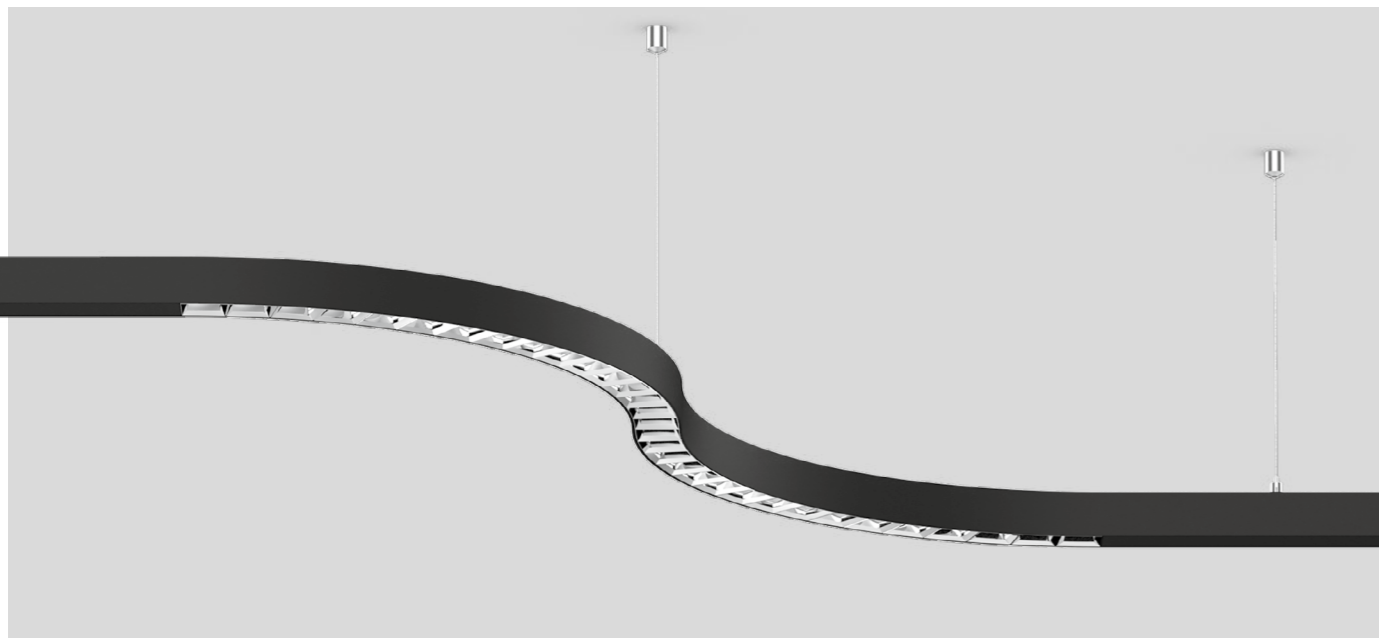

## Work-friendly light

EN As an office luminaire, BETO guarantees illumination that is compliant with workplace standards (up to  $UGR \leq 13$ ). Custom glare-free reflectors and the selected use of blind covers direct the light precisely to the work surface and reduce reflections. The direct/indirect version comes with special lens technology that distributes the indirect light component homogeneously and broadly into the room.

IT Concepito specificamente per il lavoro in ufficio, BETO assicura un'illuminazione a norma dei posti di lavoro (fino a  $UGR \leq 13$ ). I riflettori a schermatura speciale e l'uso mirato di blind-covers guidano la luce concentrandola sul piano di lavoro e riducendo i riflessi. La variante a luce diretta/indiretta possiede un'apposita ottica lenticolare che diffonde la componente indiretta a fascio molto largo ed omogeneo.

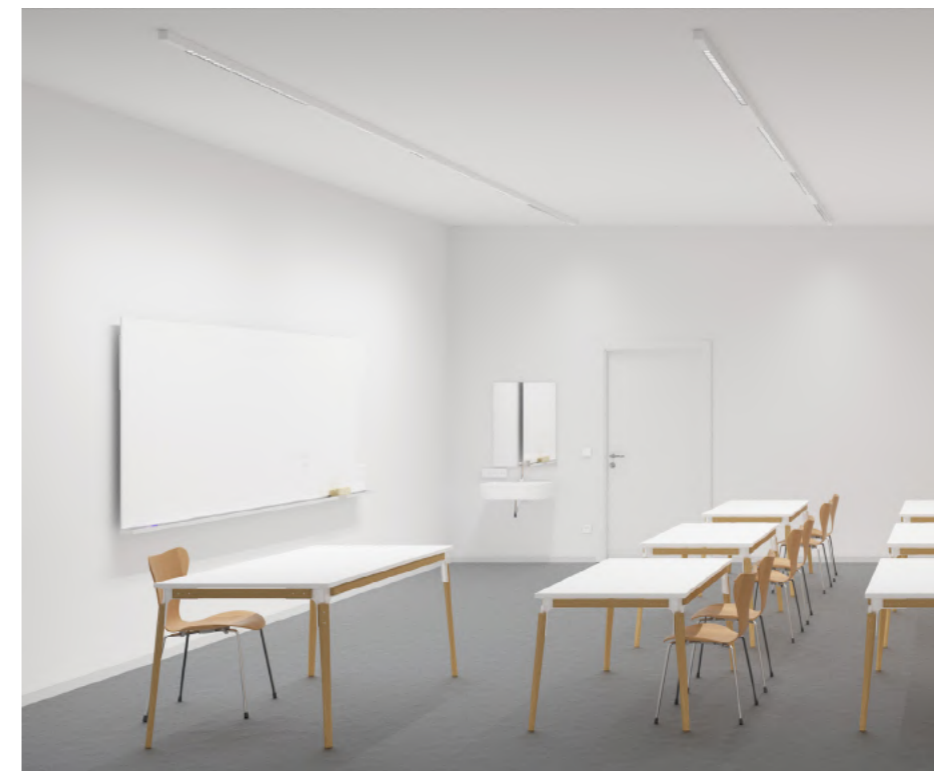

## Blackboard lighting

EN Uniform blackboard illumination is still a primary focus of good classroom lighting to hold attention and remain legible even from the back. It is often helpful during presentations to dim the lighting or to illuminate parts of the room. Pre-programmed lighting scenes can be activated, thus supporting varying teaching requirements.

IT Una valida illuminazione delle aule dà sempre la precedenza alla luminosità delle lavagne, che dovranno essere ben visibili e leggibili anche dall'ultima fila di banchi. Al momento di una proiezione ha senso abbassare il dimming dell'impianto oppure tenere illuminate solo parti dell'ambiente. Si possono attivare scenari programmati in precedenza per seguire le differenti necessità delle lezioni.

## Advanced sensor technology



EN BETO System is equipped with a DALI sensor and can be controlled as a network. A presence sensor controls the light at the workstation if someone is there. A brightness sensor adjusts the light intensity to the ambient brightness. If desks, rooms, or corridors are unoccupied, the light automatically switches off after a defined delay. This saves energy and extends the service life.

IT Provvisto di un sensore DALI, BETO System può essere controllato in rete. Un sensore di movimento regola la luce sul posto di lavoro in base alla presenza di persone. A questo si aggiunge un fotosensore che dosa l'illuminazione adattandola alla luminosità circostante. La luce si spegne automaticamente dopo un certo tempo quando le scrivanie, gli uffici o i corridoi si svuotano. Con il risultato di risparmiare energia e prolungare la durata dell'impianto.

## Full-spectrum LED

EN XAL's new XPECTRUM LEDs deliver healthy, biologically effective light. The reduced blue light and increased cyan values reduce the blue light hazard for the eye to daylight-equivalent levels. The resulting non-visual, so-called melanopic light effect, improves concentration and increases sleep quality. The excellent colour rendering of IES TM 30-15  $R_f = 98$  and  $R_g = 101$  further helps visual comfort.

IT Il nuovo XPECTRUM LED di XAL assicura una luce sana con efficacia biologica. Lo spettro riduce le componenti azzurre e aumenta invece il ciano, con il risultato di una luce simile a quella diurna in cui i rischi per gli occhi dell'azzurro sono contenuti al minimo. Ne consegue un effetto non visivo, chiamato anche melanopico, che favorisce la concentrazione e migliora la qualità del sonno. Inoltre l'eccellente resa cromatica IES TM 30-15  $R_f = 98$  e  $R_g = 101$  migliora il comfort visivo.

XPECTRUM LED

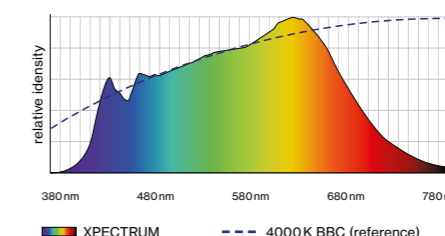

Commercially available LED 4000 K

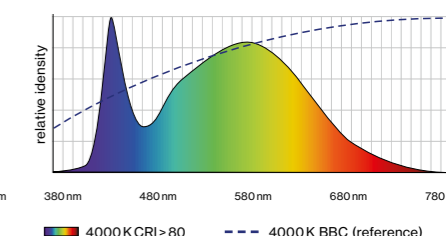

← back

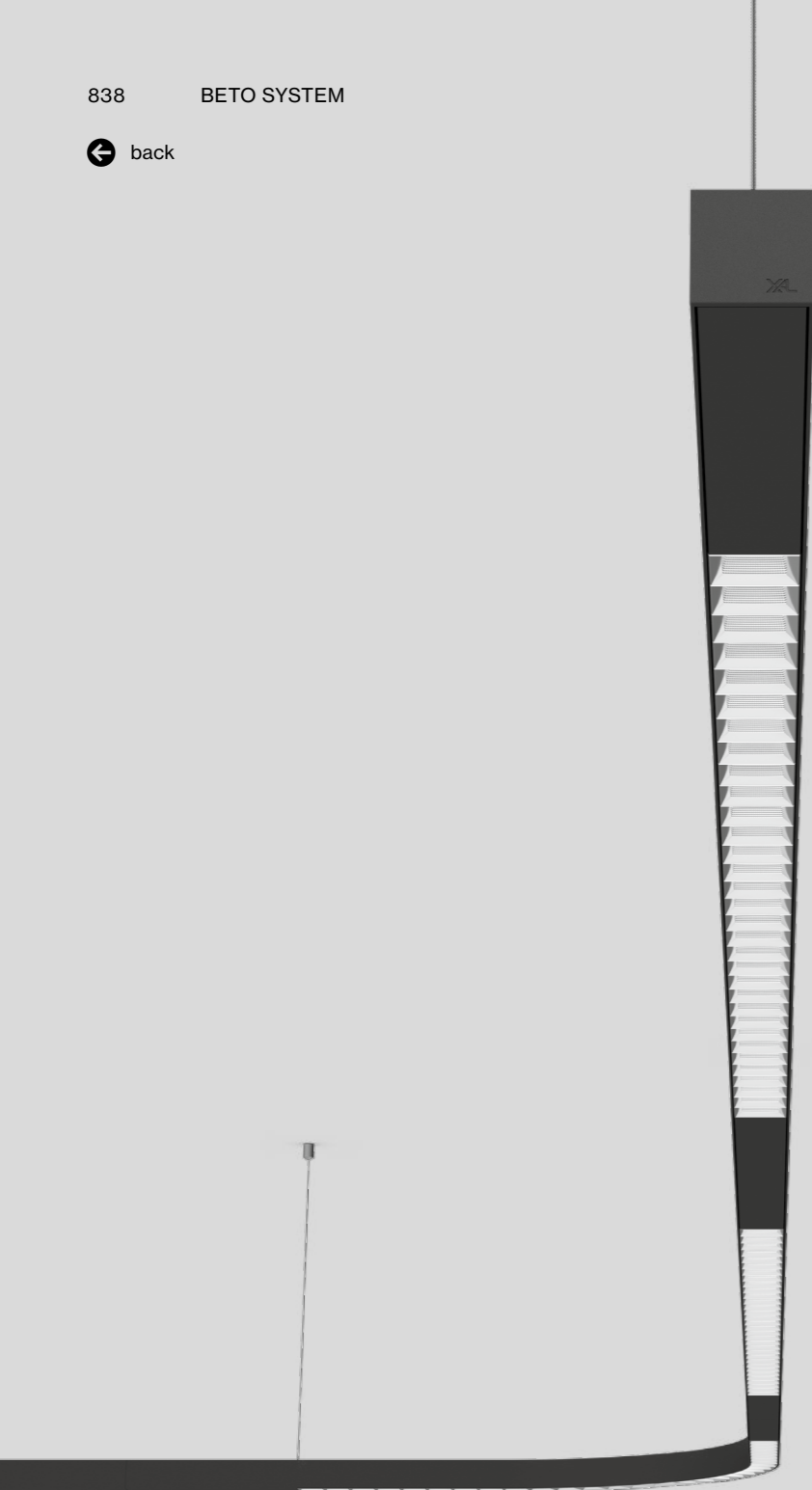

## BETO system

ceiling / suspended

EN Luminaire housing from extruded aluminium profile, angular design (only 42x42mm); no visible screws; for lighting systems; linear, S-shaped or CURVE segment (90° or 180°); powder coated; pendant fitting with cable suspension; height adjustment without tools; with transparent feeder cable; extruded profile for improved thermal management; high-gloss reflector with faceted design; direct or direct/indirect light distribution, or with high-quality aluminum-vaporised micro-faceted reflector for homogeneous vertical lighting intensity; indirect light component with integrated PCboards and high-quality lens system for max., homog. ceiling illumination, separately controllable; energy-eff. LEDs – very good colour rendering

IT Corpo illuminante in profilo di alluminio estruso, modello squadrato (solo 42 x 42mm); nessuna vite visibile; per sistemi di illuminazione; lineare, a S o elemento CURVE (90° o 180°); verniciatura a polvere; sospeso con cavo a sospensione; regolazione altezza senza utensili; con cavo di alimentazione trasparente; profilo di alluminio estruso per migliorare il bilancio termico; riflettore ad alta lucentezza con design sfaccettato; emissione diretta o diretta/indiretta, oppure con riflett. di alta qual. micro-sfaccettato vaporizzato in alluminio per illuminamento verticale omogeneo; componente luce indir. PCB speciali e ottica lent. di alta qualità per un'illuminazione omog. del soffitto, contr. separ.; LED a risp. energ. – ottima resa cromatica

### Quickinfo

3000K, 4000K, TW  
 CRI ≥ 80, 3 SDCM  
 UGR ≤ 19 / 65° ≤ 1500 cd/m²  
 L 3400 direct up to 136lm/W  
 L 3400 D/I up to 140lm/W  
 L 3400 blackboard up to 124lm/W  
 L90 @ 50 000 h  
 DALI-2, DALI sensor  
 reflector (UGR ≤ 19)

### Types

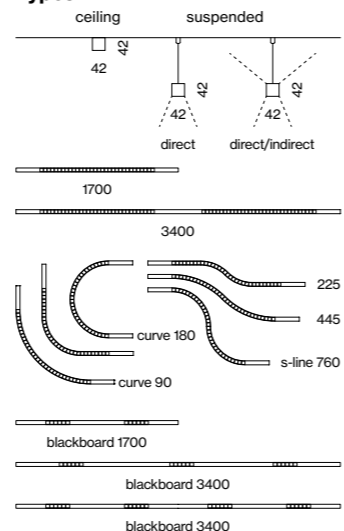

### Colours



### Light distributions

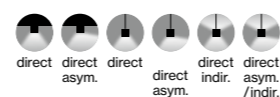

Data Monitoring

DiiA® standards  
251, 252, 253

curve elements

single luminaire  
(p. 470)

DIN EN 12464-1  
UGR ≤ 19

glare-free direct  
and 170° indirect  
illumination

CRI ≥ 98  
XPECTRUM

### Order options

COLOUR TEMPERATURE	
3000K	5
4000K	6
tunable white 2700–6500 K*	
*DALI-2 DT8	
CONTROL	
DALI-2	3
DALI sensor*	7
*brightness & presence only linear 3400 mm (not blackboard)	

MATERIAL COLOUR	
○ pure white RAL 9010	7
● jet black RAL 9005	8

LIGHT OPTIC COVER	
reflector (UGR ≤ 19)	

### Options on request

COLOUR RENDERING INDEX	
CRI ≥ 90	
CRI ≥ 98 XPECTRUM	

SYSTEM SOLUTION	
continuous reflector	
individual length	

### Light distributions

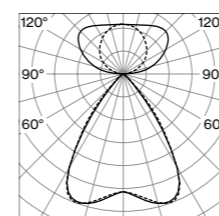

reflector (UGR ≤ 16)  
direct/indirect power

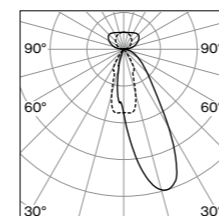

blackboard  
direct/indirect

LUMINOUS FLUX value calculated for  
CRI ≥ 80, colour white, reflector chrome

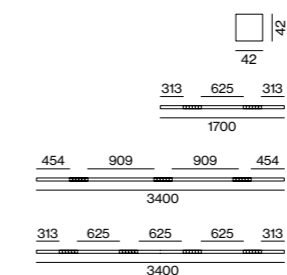
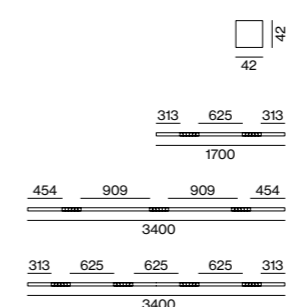
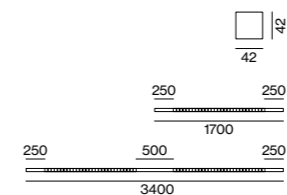
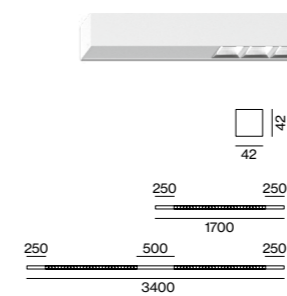

### BETO linear ceiling / suspended system

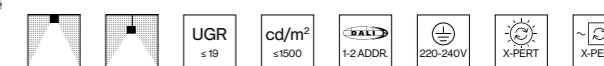

DIRECT				
SYS. POWER	COLOUR TEMP.	LUM. FLUX	L (mm)	ORDER CODE
26.1W (1×DALI)	3000K	3340lm	1700	074-6006
52W (2×DALI)	4000K	3540lm	3400	074-6009
	3000K	6680lm		
	4000K	7080lm		

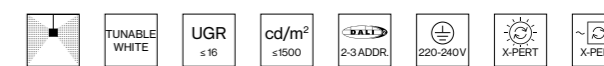

DIRECT / INDIRECT POWER				
SYS. POWER	COLOUR TEMP.	LUM. FLUX	L (mm)	ORDER CODE
57W (2×DALI)	3000K	↓ 3350 / ± 3790lm	1700	074-6036
109W (3×DALI)	4000K	↓ 3540 / ± 4020lm	3400	074-6039
109W (3×DALI)	3000K	↓ 6690 / ± 7590lm	3400	074-60D95
109W (3×DALI)	4000K	↓ 7080 / ± 8040lm	3400	074-60D96
109W (3×DALI)	2700–6500K	± 6810lm		
109W (3×DALI)	4000K	± 6810lm	3400	074-60D96
109W (3×DALI)	2700–6500K	± 6810lm		



BLACKBOARD WALLWASHER				
SYS. POWER	COLOUR TEMP.	LUM. FLUX	L (mm)	ORDER CODE
48W (1×DALI)	3000K	4940lm	1700	074-7706
72W (2×DALI)	4000K	5100lm	3400	074-7719
90W (2×DALI)	3000K	7420lm	3400	074-7729
	4000K	7630lm		
	3000K	9890lm	3400	074-7729
	4000K	10180lm		



BLACKBOARD WALLWASHER / INDIRECT				
SYS. POWER	COLOUR TEMP.	LUM. FLUX	L (mm)	ORDER CODE
79W (2×DALI)	3000K	↓ 4940 / ± 3780lm	1700	074-7736
127W (3×DALI)	4000K	↓ 5090 / ± 4000lm	3400	074-7749
150W (3×DALI)	3000K	↓ 7420 / ± 7680lm	3400	074-7759
	4000K	↓ 7630 / ± 8130lm		
	3000K	↓ 9890 / ± 7680lm	3400	074-7759
	4000K	↓ 10180 / ± 8130lm		

### Accessories

END CAPS	
TYPE	ORDER CODE
end caps (pair)	074-609001

LINEAR CONNECTOR	
TYPE	ORDER CODE
mechanical linear connector ceiling	074-6091110

CEILING FASTENER / CABLE SUSPENSION / POWER FEEDER		
TYPE	L (mm)	ORDER CODE
ceiling fastener	67	050-204121
cable suspension	1500	005-2152110
canopy / feeder cable 5 × 1.5 mm²	1500	005-221241
through wire 5 × 1.5 mm² (10 pieces)		004-90005

more accessories see page 841

← back

**Order options**

COLOUR TEMPERATURE	
3000K	5
4000K	6

CONTROL	
DALI-2	

MATERIAL COLOUR	
○ pure white RAL 9010	7
● jet black RAL 9005	8

LIGHT OPTIC COVER	
reflector (UGR ≤ 16)	

**Options on request**

COLOUR RENDERING INDEX	
CRI ≥ 90	
CRI ≥ 98 XPECTRUM	

**BETO curve ceiling/suspended system**

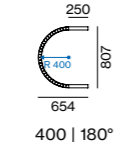
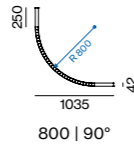
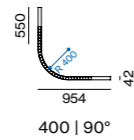

DIRECT				
SYS. POWER	COLOUR TEMP.	LUM. FLUX	R (mm)	ORDER CODE
26.1W	3000K	3470 lm	400 90°	074-7101::3
	4000K	3680 lm		
26.1W	3000K	3470 lm	800 90°	074-7103::3
	4000K	3680 lm		
26.1W	3000K	3470 lm	400 180°	074-7102::3
	4000K	3680 lm		



DIRECT / INDIRECT POWER				
S. POWER	COLOUR TEMP.	LUM. FLUX	R (mm)	ORDER CODE
57W	3000K	↓ 3470 / ↑ 3860 lm	400 90°	074-7131::3
	4000K	↓ 3680 / ↑ 4080 lm		
57W	3000K	↓ 3470 / ↑ 3860 lm	800 90°	074-7133::3
	4000K	↓ 3680 / ↑ 4080 lm		
57W	3000K	↓ 3470 / ↑ 3860 lm	400 180°	074-7132::3
	4000K	↓ 3680 / ↑ 4080 lm		

**BETO s-line ceiling/suspended system**

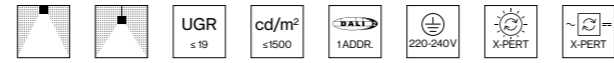
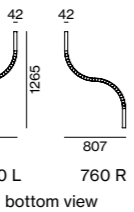
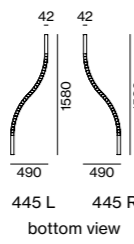
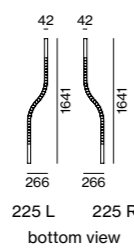

DIRECT				
SYS. POWER	COLOUR TEMP.	LUM. FLUX	TYPE	ORDER CODE
26.1W	3000K	3470 lm	225 L	074-7201::3
	4000K	3680 lm		
26.1W	3000K	3470 lm	225 R	074-7202::3
	4000K	3680 lm		
26.1W	3000K	3470 lm	445 L	074-7205::3
	4000K	3680 lm		
26.1W	3000K	3470 lm	445 R	074-7206::3
	4000K	3680 lm		
26.1W	3000K	3470 lm	760 L	074-7203::3
	4000K	3680 lm		
26.1W	3000K	3470 lm	760 R	074-7204::3
	4000K	3680 lm		



DIRECT / INDIRECT POWER				
S. POWER	COLOUR TEMP.	LUM. FLUX	TYPE	ORDER CODE
57W	3000K	↓ 3470 / ↑ 3860 lm	225 L	074-7231::3
	4000K	↓ 3680 / ↑ 4080 lm		
57W	3000K	↓ 3470 / ↑ 3860 lm	225 R	074-7232::3
	4000K	↓ 3680 / ↑ 4080 lm		
57W	3000K	↓ 3470 / ↑ 3860 lm	445 L	074-7235::3
	4000K	↓ 3680 / ↑ 4080 lm		
57W	3000K	↓ 3470 / ↑ 3860 lm	445 R	074-7236::3
	4000K	↓ 3680 / ↑ 4080 lm		
57W	3000K	↓ 3470 / ↑ 3860 lm	760 L	074-7233::3
	4000K	↓ 3680 / ↑ 4080 lm		
57W	3000K	↓ 3470 / ↑ 3860 lm	760 R	074-7234::3
	4000K	↓ 3680 / ↑ 4080 lm		

**Light distribution**

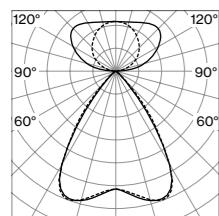

reflector (UGR ≤ 16)  
direct / indirect power

LUMINOUS FLUX value calculated for CRI ≥ 80, colour white, reflector chrome

**Order options**

MATERIAL COLOUR	
○ pure white RAL 9010	7
● jet black RAL 9005	8

**Accessories**

END CAPS		ORDER CODE
TYPE	end caps (pair)	074-609001

LINEAR CONNECTOR		ORDER CODE
TYPE	mechanical linear connector suspended	074-6091120
incl. 1500mm cable suspension		

CORNER CONNECTOR 90°		ORDER CODE
TYPE	corner connector 90°	074-609121
incl. through wire 5 × 1.5 mm <sup>2</sup> ; order two mechanical linear connectors separately		

BLIND COVER		ORDER CODE
TYPE	blind cover 250 mm	074-609910
	blind cover 500 mm	074-609911
order 1 × blind cover 500 mm for each linear connector and 1 × 250 mm for each end		

CABLE SUSPENSION / CANOPY / THROUGH WIRE			ORDER CODE
TYPE		L (mm)	
	cable suspension	1500	005-2152110
	canopy / feeder cable 5 × 1.5 mm <sup>2</sup>	1500	005-221241
	through wire 5 × 1.5 mm <sup>2</sup> (10 pieces)		004-90005
for electrical system configuration see luminaire data sheet at xal.com			

**Arrangement examples (top view)**

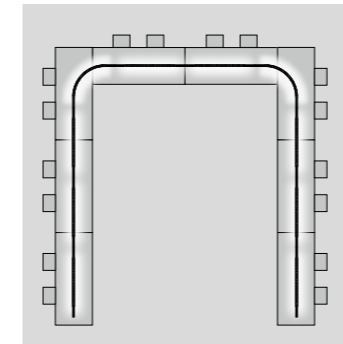

**BETO CURVE 90**  
conference/seminar

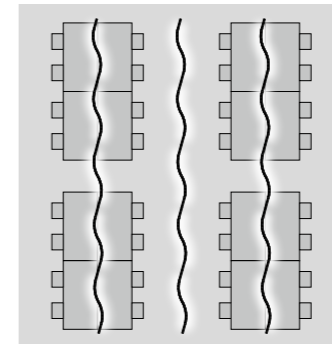

**BETO S-LINE 445**  
office

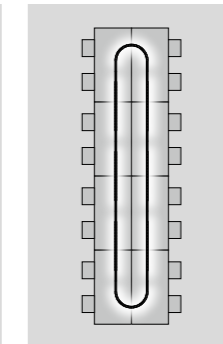

**BETO CURVE 180**  
conference/seminar

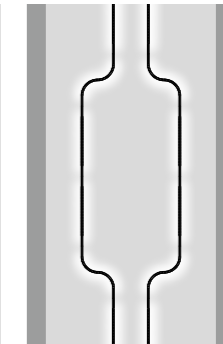

**BETO S-LINE 760**  
corridor

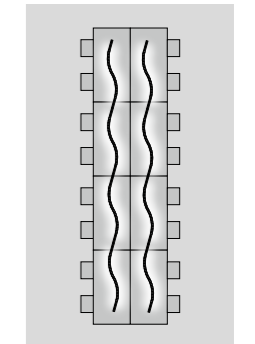

**BETO S-LINE 445**  
conference/seminar

**Technical data (top view)**

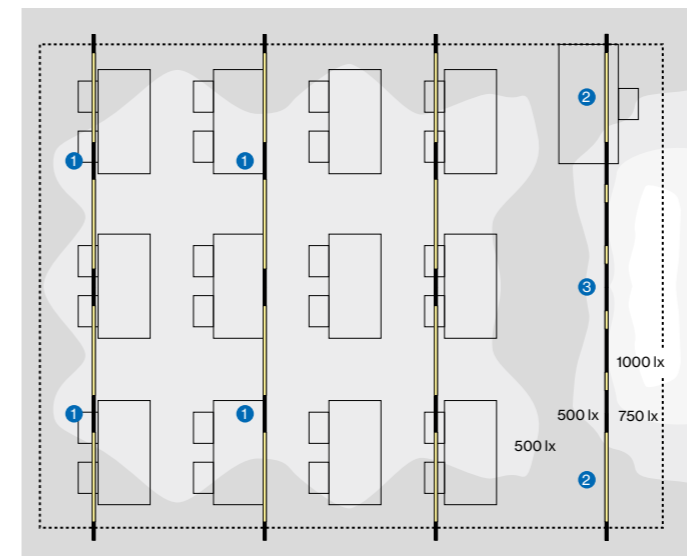

- 1 BETO 3400 ceiling system, 52 W, 4000 K
- 2 BETO 1700 ceiling system, 26.1 W, 4000 K
- 3 BETO 3400 blackboard ceiling system, 90 W, 4000 K

ROOM VALUES		CALCULATION SURFACE .....	
Room dimensions	9.5 × 7.5 × 3 m	Surface dimensions	8.5 × 6.5
Reflection factor	0.7   0.5   0.2	Surface height	0.75
Maintenance factor	0.8	Average illuminance (E <sub>v</sub> )	> 500 lx
Mounting height	3 m	Uniformity (U <sub>0</sub> )	> 0.6

GLARE EVALUATION	
Table Classification X=4H   Y=8H   S=0.25H	
UGR transversal	≤ 19
UGR axial	≤ 19

Office  
Visualisation





**Creative Lab** Barcelona, ES –  
lighting design by MMAS Lighting  
tables designed by James Burleigh



**F+P Architekten ZT GmbH**  
Vienna, AT – by F+P Architekten ZT  
GmbH with lighting design by Ing.  
Gerald Pummer, Illuminazione



**Office Inarto Architecten**  
Herentals, BE – by Inarto Architecten





# The art of round efficiency

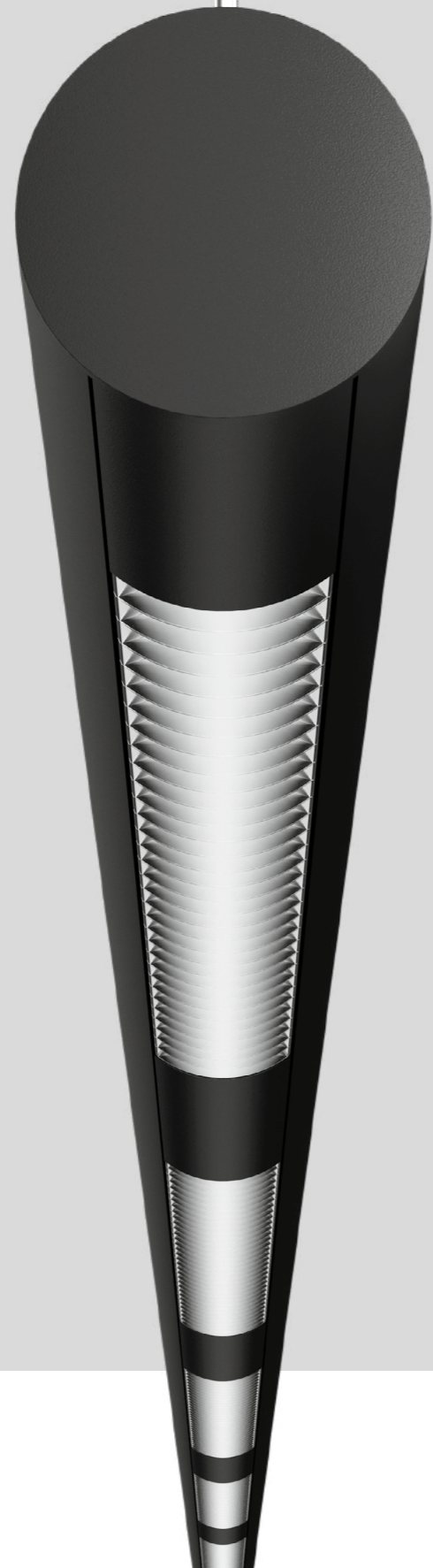

## SETA system

**EN** The SETA system luminaire is perfect for bespoke office needs with a choice of straight or angular elements that can be arranged in any order. The minimalist yet powerful luminaire is available in ceiling-mounted or suspended system versions. Particularly noteworthy are the reflectors optimised for office spaces, which were designed specifically for working on screens. The indirect light component creates a pleasant, homogeneous ceiling illumination for every work area. The SETA System luminaire is also available on request with presence and brightness sensors, and in the light colours 3000 K, 4000 K, and, depending on the version, also in Tunable White.

**IT** L'apparecchio SETA in sistema comprende elementi lineari oppure angolari che si allineano nel modo preferito seguendo le necessità individuali degli uffici. Minimalista ma comunque molto performante, l'apparecchio è previsto per montaggio a plafone oppure a sospensione. Particolarmente degni di nota sono i riflettori di costruzione speciale, concepiti per il lavoro al computer. Una componente di luce indiretta diffonde sul soffitto una luminosità omogenea che assicura un'atmosfera gradevole. In opzione SETA può essere dotato di sensori di presenza e luminosità. L'apparecchio è disponibile con luce di tonalità 3000 K, 4000 K oppure Tunable White.

### Types

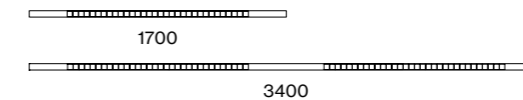

### Mountings

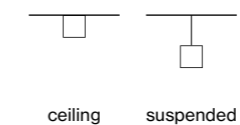

### Configurations

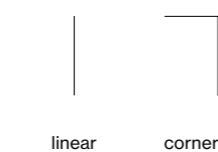

### Light distributions

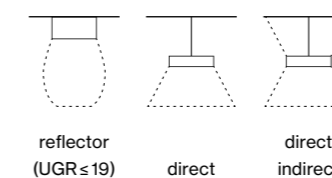

## Work-friendly light

EN As an office luminaire, SETA guarantees illumination that is compliant with workplace standards (up to  $UGR \leq 16$ ). Custom glare-free reflectors and the selected use of blind covers direct the light precisely to the work surface and reduce reflections. The direct/indirect version comes with special lens technology that distributes the indirect light component homogeneously and broadly towards the ceiling.

IT Concepito specificamente per il lavoro in ufficio, SETA assicura un'illuminazione a norma dei posti di lavoro (fino a  $UGR \leq 16$ ). I riflettori a schermatura speciale e l'uso mirato di blind-covers guidano la luce concentrandola sul piano di lavoro e riducendo i riflessi. La variante a luce diretta/indiretta possiede un'apposita ottica lenticolare che diffonde la componente indiretta a fascio molto largo ed omogeneo.

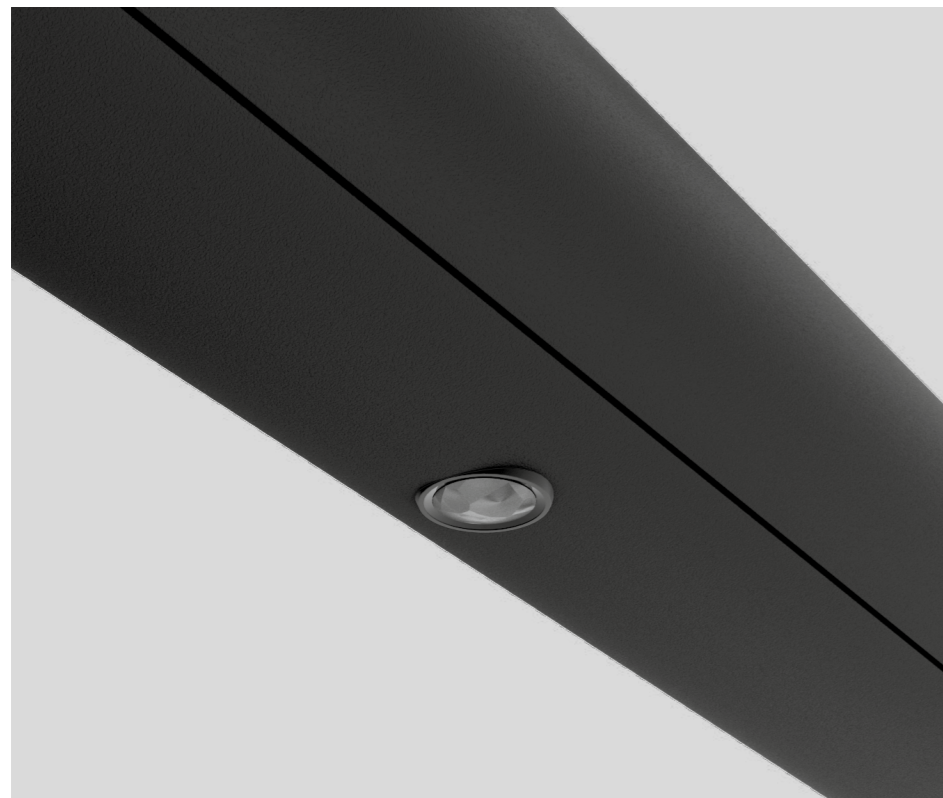

## Advanced sensor technology

EN SETA System is equipped with a DALI sensor and can be controlled as a network. A presence sensor controls the light at the workstation depending on whether anyone is in the vicinity. If desks, rooms, or corridors are unoccupied, the light automatically switches off after a defined delay. This saves energy and extends the service life. A brightness sensor adjusts the light intensity to the ambient brightness.

IT Provisto di un sensore DALI, SETA System può essere controllato in rete. Un sensore di movimento regola la luce sul posto di lavoro in base alla presenza di persone. A questo si aggiunge un fotosensore che dosa l'illuminazione adattandola alla luminosità circostante. La luce si spegne automaticamente dopo un certo tempo quando le scrivanie, gli uffici o i corridoi si svuotano. Con il risultato di risparmiare energia e prolungare la durata dell'impianto.



## Lines & edges

EN SETA System comes as a suspended luminaire with straight and angular system elements. Thus, SETA offers a lighting solution that fits into any lighting design concept. Optionally with an indirect light component, the light is distributed homogeneously across the ceiling and creates a pleasant room atmosphere.

IT Il sistema SETA è disponibile come apparecchio a sospensione con elementi lineari e angolari: in questo modo offre una soluzione illuminotecnica capace di adattarsi ad ogni allestimento. Con l'opzione della luce indiretta, il soffitto ricava una luminosità omogenea che assicura un'atmosfera gradevole.

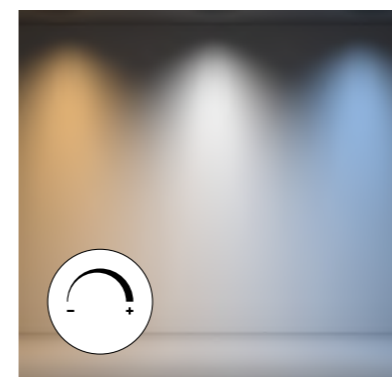

## TW – Tunable White

EN Changes in the colour of light have a substantial effect on our mood. Tunable White allows the colour temperature to be continuously adjusted from 2700 K (warm light) to 6500 K (cool light) to dynamically adapt the lighting to the time of day or ambient brightness.

IT I cambiamenti del colore di luce hanno un effetto importante sul nostro stato d'animo. Tunable White consente di variare la temperatura di colore in regolazione continua da 2700 K (luce calda) a 6500 K (luce fredda), adattando dinamicamente l'illuminazione artificiale all'ora del giorno o alla luminosità circostante.

## Full-spectrum LED

EN XAL's new XPECTRUM LEDs deliver healthy, biologically effective light. The reduced blue light component and increased cyan values reduce the blue light hazard for the eye to daylight-equivalent levels. The resulting non-visual, so-called melanopic light effect, improves concentration and increases sleep quality. The excellent colour rendering of IES TM 30-15  $R_f = 98$  and  $R_g = 101$  further helps visual comfort.

IT Il nuovo XPECTRUM LED di XAL assicura una luce sana con efficacia biologica. Lo spettro riduce le componenti azzurre e aumenta invece il ciano, con il risultato di una luce simile a quella diurna in cui i rischi per gli occhi dell'azzurro sono contenuti al minimo. Ne consegue un effetto non visivo, chiamato anche melanopico, che favorisce la concentrazione e migliora la qualità del sonno. Inoltre l'eccellente resa cromatica IES TM 30-15  $R_f = 98$  e  $R_g = 101$  migliora il comfort visivo.

XPECTRUM LED

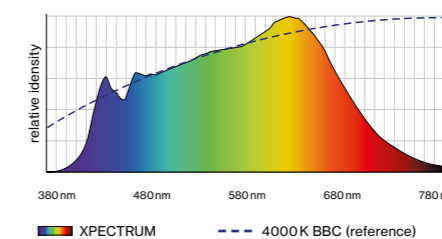

Commercially available LED 4000 K

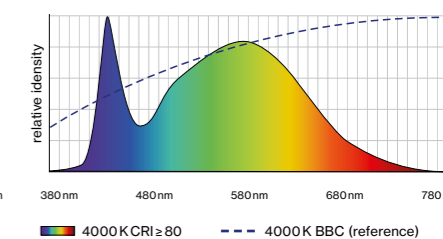

← back

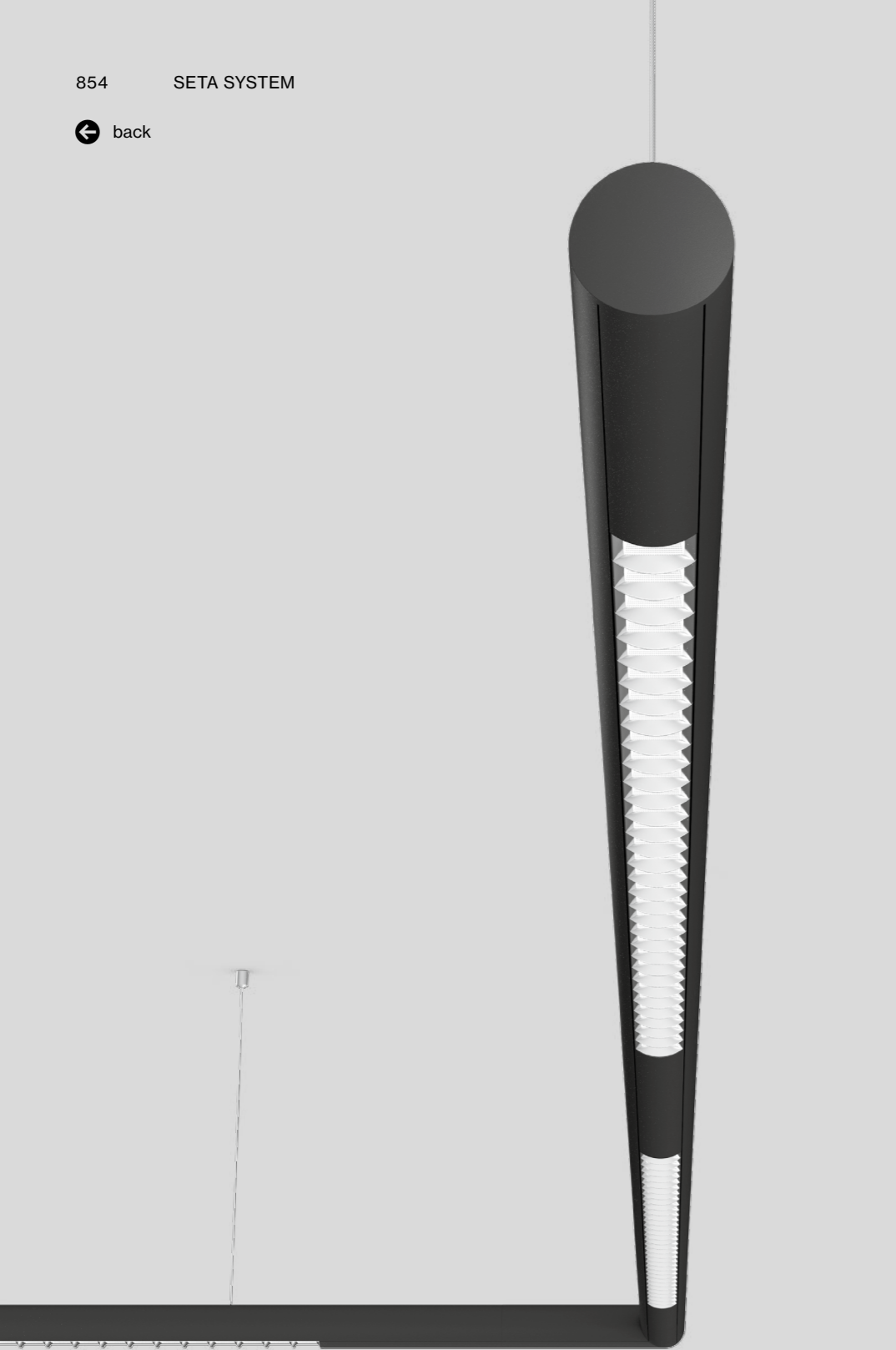

## SETA system

ceiling / suspended

**EN** Luminaire housing from extruded aluminium profile, round design (only  $\varnothing 61\text{mm}$ ); no visible screws; for lighting systems; linear; powder coated; pendant fitting with cable suspension; height adjustment without tools; with transparent feeder cable; extruded profile for improved thermal management; high-gloss reflector with faceted design; direct or direct/indirect light distribution; indirect light component with integrated PC boards and high-quality lens system for max., homog. ceiling illumination, separately controllable; energy-eff. LEDs – very good colour rendering

**IT** Corpo illuminante in profilo di alluminio estruso, modello rotondo (solo  $\varnothing 61\text{mm}$ ); nessuna vite visibile; per sistemi di illuminazione; lineare; verniciatura a polvere; sospeso con cavo a sospensione; regolazione altezza senza utensili; con cavo di alimentazione trasparente; profilo di alluminio estruso per migliorare il bilancio termico; riflettore ad alta lucentezza con design sfaccettato; emissione diretta o diretta/indiretta; componente luce indir. PCB speciali e ottica lent. di alta qualità per un'illuminazione omog. del soffitto, contr. separ.; LED a risp. energ. – ottima resa cromatica

### Quickinfo

3000K, 4000K, TW  
 CRI  $\geq 80$ , 3 SDCM  
 UGR  $\leq 19$ /  $65^\circ \leq 1500\text{cd/m}^2$   
 L 3400 direct up to  $136\text{lm/W}$   
 L 3400 D/I up to  $140\text{lm/W}$   
 L90 @ 50 000h  
 DALI-2, DALI sensor  
 reflector (UGR  $\leq 19$ )

### Types

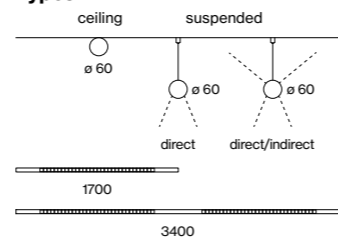

### Colours



### Light distributions



DiiA® standards  
251, 252, 253



special end cap  
design



corner  
connector



DIN EN 12464-1  
UGR  $\leq 19$

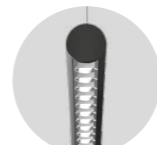

single luminaire  
(p.486)

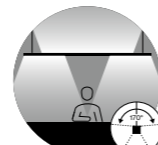

glare-free direct  
and  $170^\circ$  indirect  
illumination

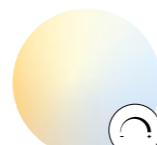

tunable white  
2700–6500 K

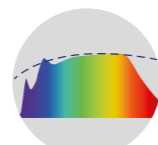

CRI  $\geq 98$   
XPECTRUM

### Order options

COLOUR TEMPERATURE	
3000 K	5
4000 K	6
tunable white 2700–6500 K*	
*DALI-2 DT8	

CONTROL	
DALI-2	3
DALI sensor*	7
*brightness & presence   only 3400 mm	

MATERIAL COLOUR	
white	7
black	8

LIGHT OPTIC COVER	
reflector (UGR $\leq 19$ )	

### Options on request

COLOUR RENDERING INDEX	
CRI $\geq 90$	
CRI $\geq 98$ XPECTRUM	

MATERIAL COLOUR	
grey	

### Light distribution

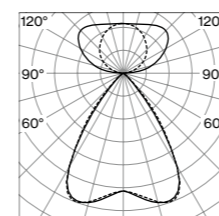

reflector (UGR  $\leq 19$ )  
direct/indirect power

**LUMINOUS FLUX** value calculated for  
CRI  $\geq 80$ , colour white, reflector chrome

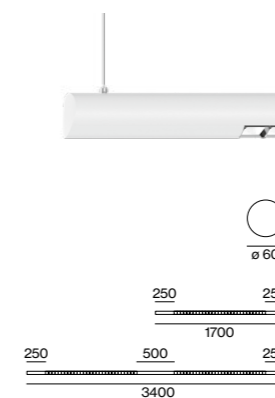
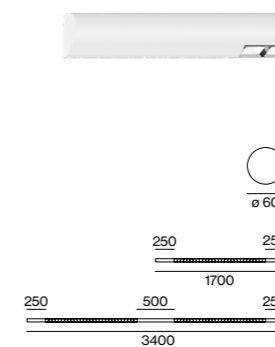

### SETA ceiling/suspended system

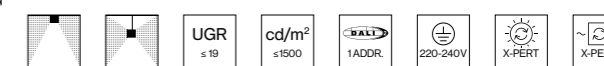

#### LINEAR DIRECT

SYS. POWER	COLOUR TEMP.	LUM. FLUX	L (mm)	ORDER CODE
26.1W (1×DALI)	3000K 4000K	3340lm 3540lm	1700	074-5006
52W (2×DALI)	3000K 4000K	6680lm 7080lm	3400	074-5009

### SETA suspended system

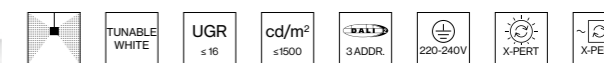

#### LINEAR DIRECT / INDIRECT POWER

SYS. POWER	COLOUR TEMP.	LUM. FLUX	L (mm)	ORDER CODE
57W (2×DALI)	3000K 4000K	↓ 3350 / ↑ 3790lm ↓ 3540 / ↑ 4020lm	1700	074-5036
109W (3×DALI)	3000K 4000K	↓ 6690 / ↑ 7590lm ↓ 7080 / ↑ 8040lm	3400	074-5039
109W (3×DALI)	3000K 2700–6500K	↓ 6690lm ↑ 6810lm	3400	074-50D95
109W (3×DALI)	4000K 2700–6500K	↓ 7080lm ↑ 6810lm	3400	074-50D96

### Accessories

#### END CAPS



TYPE	ORDER CODE
end caps (pair)	074-509001

#### LINEAR CONNECTOR / CORNER CONNECTOR 90°

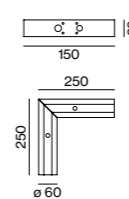

TYPE	ORDER CODE
mechanical linear connector ceiling	074-5091110
mechanical linear connector suspended*	074-6091120
corner connector 90°**	074-5091210

\* incl. 1500 mm cable suspension; \*\* incl. through wire 5×1.5 mm<sup>2</sup>;  
order two mechanical linear connectors separately

#### BLIND COVER

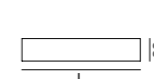

TYPE	ORDER CODE
blind cover 250 mm	074-509910
blind cover 500 mm	074-509911

order 1× blind cover 500 mm for each linear connector and 1×250 mm for each end

#### CEILING FASTENER

TYPE	L (mm)	ORDER CODE
ceiling fastener	67	050-204121

#### CABLE SUSPENSION / CANOPY / THROUGH WIRE

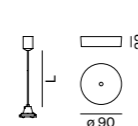

TYPE	L (mm)	ORDER CODE
cable suspension	1500	005-2152110
canopy / feeder cable 5×1.5 mm <sup>2</sup>	1500	005-221241
through wire 5×1.5 mm <sup>2</sup> (10 pieces)		004-90005

for electrical system configuration see luminaire data sheet at xal.com

**Office**  
Visualisation



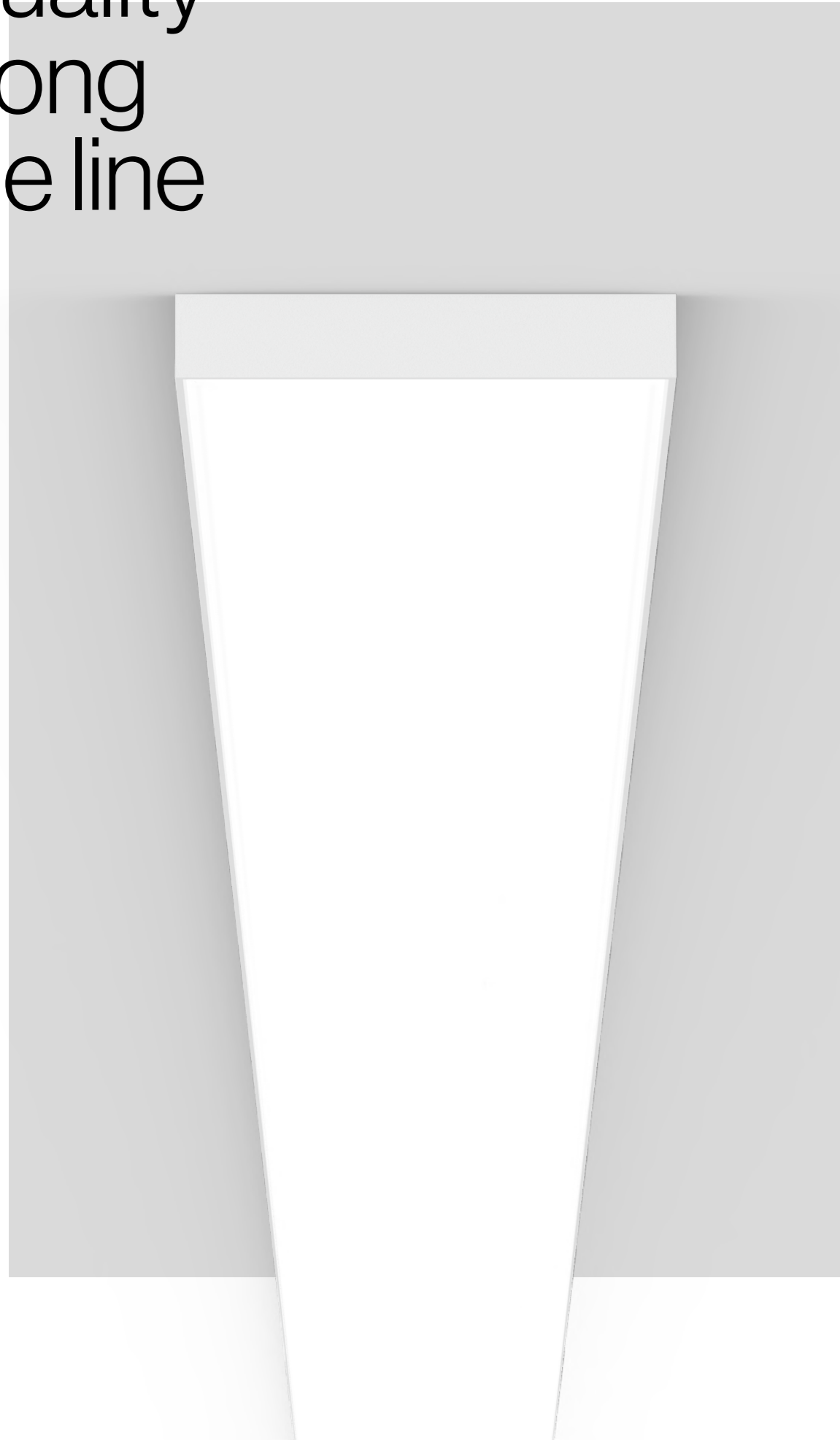

# Quality along the line



## LENO system

**EN** The extremely flat LENO profile luminaire is surprisingly versatile. It is available as a recessed, semi-recessed, or surface-mounted version for wall or ceiling mounting, in a suspended version. LENO and its microprismatic cover create ideal work light. The version with an opal cover is best suited for homogeneous room lighting. The variant with asymmetrical beam distribution illuminates walls homogeneously. LENO Jut-Out adds further ceiling illumination by employing discreet lateral radiation. By simply fixing the insets magnetically, assembly is quick and flexible.

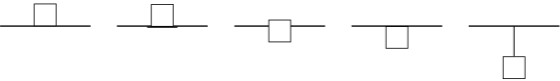
**IT** I sottilissimi profili luminosi LENO sorprendono per la loro versatilità. Sono disponibili per montaggio su pareti e soffitti, a incasso e semi-incasso, plafone e sospensione oppure. La cover microprismatica diffonde la luce con una schermatura adatta alle postazioni di lavoro, mentre la variante opale assicura un'illuminazione omogenea. Altre opzioni sono l'emissione asimmetrica per i piani verticali e il modello LENO Jut-Out che migliora la luminosità del soffitto con una sobria diffusione laterale. Tutti i moduli si fissano con sistema magnetico, rapido e flessibile.

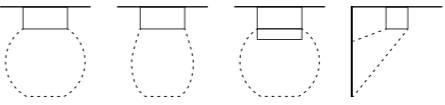
<b>Type</b>	
	90
<b>Mountings</b>	
	trimless recessed   trim recessed   semi-recessed   surface   suspended
<b>Configuration</b>	
	linear
<b>Light distributions</b>	
	opal   microprismatic (UGR ≤ 19)   jut-out   wallwasher

## Magnetic attachment

EN Simple and utterly tool-free installation: LENO luminaire insets are magnetically fixed in the profile. The patented system saves time and money when installing the luminaire.

IT Montaggio semplice e senza alcun'attrezzatura: gli inserti luminosi LENO si fissano nei profili con sistema magnetico. Il sistema brevettato per incassare il corpo illuminante fa risparmiare tempo e costi.

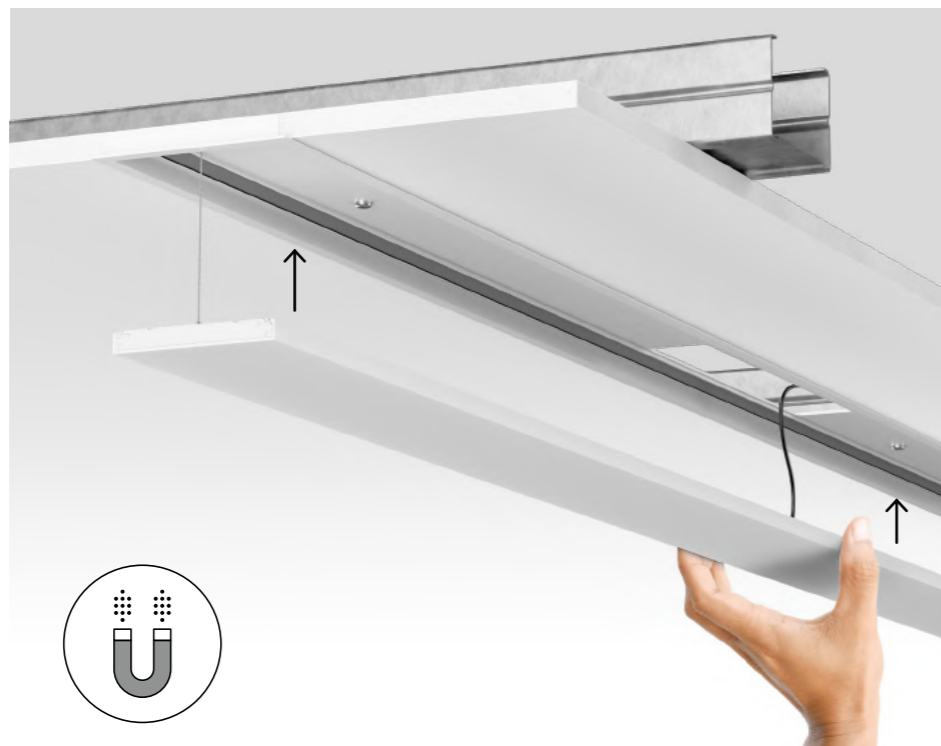

## Slim and efficient

EN Innovative lighting technology, minimal profile heights. The extremely flat flush-mounted variants, both with and without a trim, match the height of plasterboard. They are therefore easily mounted on any ceiling, regardless of its substructure. This grants maximum design freedom with a slim appearance and impressive efficiency.

IT Illuminotecnica innovativa, spessori minimi dei profili. I sottilissimi elementi da incasso, con o senza cornice, hanno lo spessore di un pannello di cartongesso. Pertanto si montano senza problemi su qualsiasi soffitto, a prescindere dalla sua struttura portante. Massima libertà di composizione, aspetto slanciato ed efficienza imbattibile.

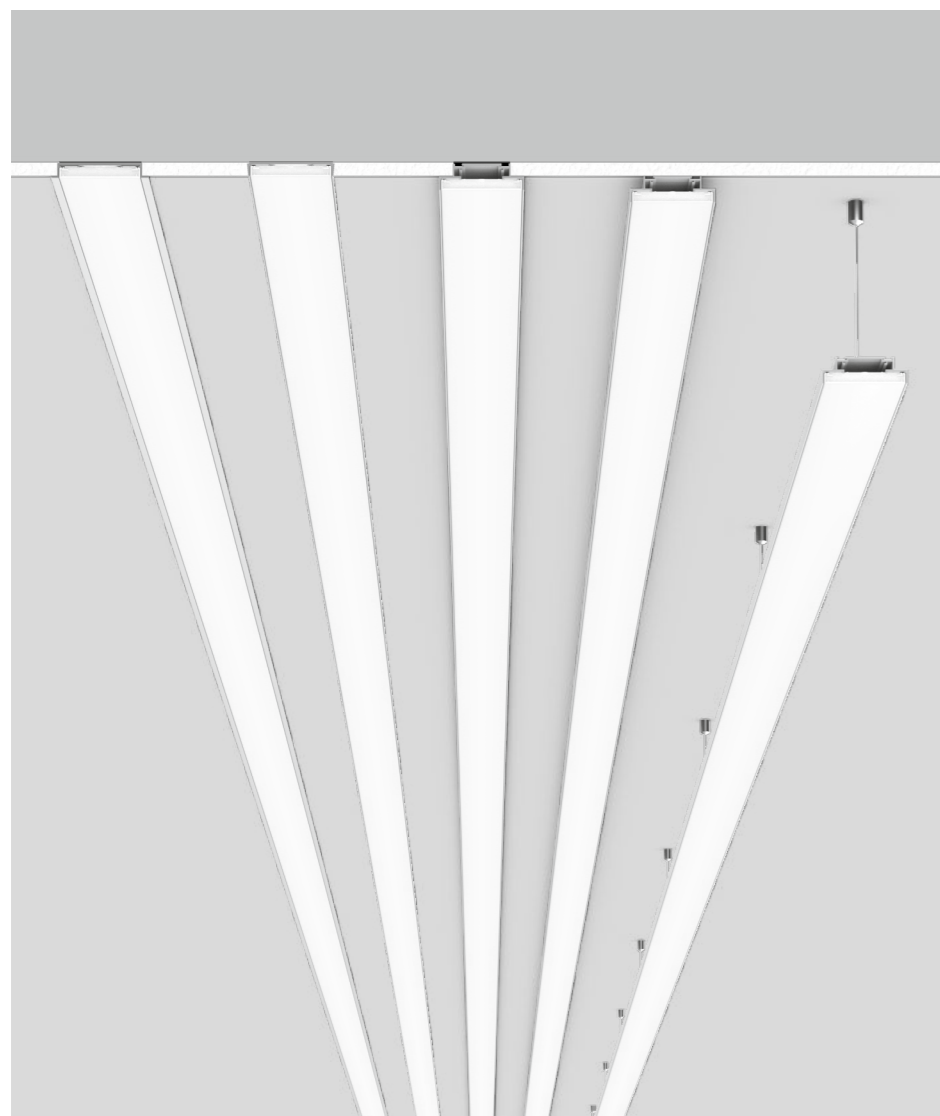
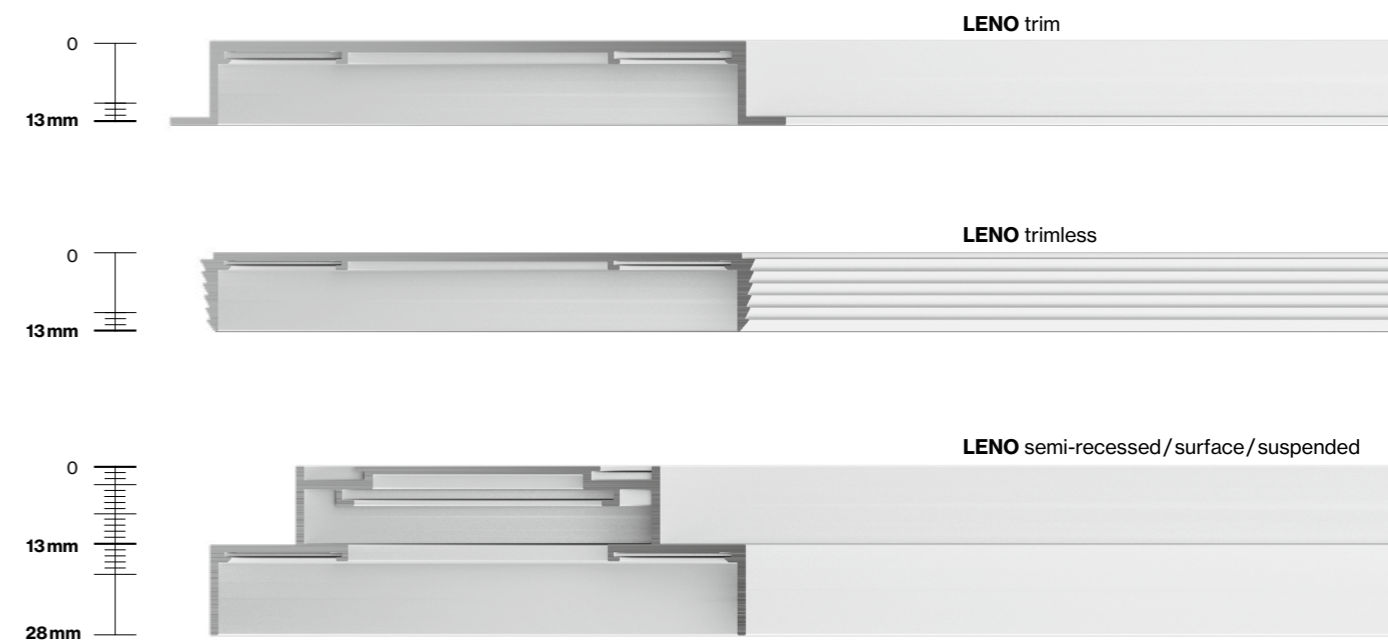

## Variety

EN Available for installation in plasterboard ceilings, suspended, or as a surface-mounted variant, this exceptionally flat profile luminaire has precise, homogeneously illuminated edges and can be used in a variety of ways. Choose between the high-performance Opal Cover inset for homogeneous illumination, the workplace-compatible micro-prismatic cover ( $UGR \leq 19$ ) or the opal Jut-Out version for improved room and ceiling illumination. Different lengths and optional asymmetrical light distribution complete the range.

IT Incasso in controsoffitti di cartongesso, montaggio a sospensione oppure a plafone: questo corpo illuminante ultrasottile, con luminosità omogenea e precisa, si presta a molte destinazioni. Si può scegliere la variante opale High Performance per un'illuminazione uniforme, oppure la cover microprismatica per le postazioni di lavoro ( $UGR \leq 19$ ), o anche la versione opale Jut-Out per migliorare la luminosità dell'ambiente e del soffitto. Sono disponibili varie lunghezze e una distribuzione asimmetrica opzionale.

## Single or system

EN LENO is flexible and available in four lengths, and as a system luminaire in any length. Depending on requirements, the elements are simply mechanically connected – tailored to match the design of the interior. LENO can create a particularly powerful, continuous lighting system, granting maximum freedom of design.

IT LENO è disponibile come, in quattro lunghezze, oppure come sistema di qualsiasi lunghezza. Gli elementi si collegano meccanicamente con semplicità e si adattano al design dell'ambiente. Con LENO si possono realizzare anche file continue: la libertà compositiva pertanto è massima.



← back



# LENO system

recessed with trim

**EN** Low profile recessed channel; suitable for installation in 12.5 mm ceilings, with trim; suitable for wall or ceiling mounting; for continuous lighting systems; surface powder coated; easy mounting without need to cut the substructure; fall-safe light inset made of extruded aluminium profile, can be inserted in the canal without tools by magnetic holders; side coupled light, directed downwards by LGP body (Light Guiding Prism) and highly efficient reflector; homogeneously illuminated, satinised (flush or jut-out) or microprismatic PMMA cover; optional with asymmetric light distribution; energy-eff. LEDs – very good colour rendering; incl. external converter for ceiling insertion

**IT** Apparecchio da incasso ultrapiatto; per incasso in soffitti di 12,5 mm, con bordo perimetrale; per montaggio a parete o soffitto; per file continue; verniciatura a polvere; montaggio semplice senza taglio della struttura sottostante; inserto luce anti-caduta in profilo di alluminio estruso, fissaggio nel canale con magneti senza bisogno di utensili; luce convogliata lateralmente e direzionata in basso con sistema LGP-Body (Light Guiding Prism) e riflettore ad alta efficienza; diffusore satinato (a filo o sporgente) o con struttura a microprismi a illuminazione omogenea in PMMA; in opzione con distribuzione asimmetrica della luce; LED a risp. energ. – ottima resa cromatica; incl. converter esterno da inserire nel soffitto

## Quickinfo

3000K, 4000K  
 CRI ≥ 80, 3 SDCM  
 up to 137lm/W  
 L90 @ 50 000h  
 DALI-2  
 opal, microprismatic (UGR ≤ 19),  
 jut-out, asymmetric wallwasher

## Types

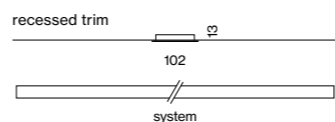

## Colour



## Light distributions

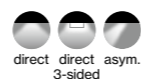

## Order options

COLOUR TEMPERATURE	
3000K	5
4000K	6

## CONTROL

DALI-2

## MATERIAL COLOUR

○ traffic white RAL 9016

## LIGHT OPTIC COVER

opal high performance	H
microprismatic (UGR ≤ 19)	G
jut-out	J
asymmetric	A

## Options on request

## COLOUR RENDERING INDEX

CRI ≥ 90

## EMERGENCY LIGHT

1h accupack  
 3h accupack

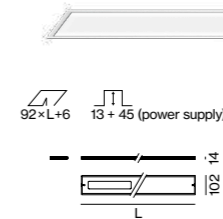

## LENO trim

### INSTALLATION CHANNEL

TYPE	L (mm)	ORDER CODE
channel	613	051-8910067
channel	1221	051-8910127
channel	1830	051-8910187
channel	2438	051-8910247

order installation channel, light inset + mounting accessories separately



### LIGHT INSET

SYS. POWER (OPAL, MP, JUT-OUT / ASYM.)	L (mm)	ORDER CODE
10.8W/15.6W	612	051-8012370
19.1W/31W	1220	051-8014370
28.6W/47W	1828	051-8016370
38W/62W	2436	051-8018370

COVER	COLOUR TEMP.	SYSTEM POWER	DELIVERED LUMENS	EFFICACY
opal high	3000K	17.6 W/m	2010 lm/m	129 lm/W
performance	4000K		2130 lm/m	137 lm/W
microprismatic	3000K	17.6 W/m	1900 lm/m	122 lm/W
UGR ≤ 19	4000K		2010 lm/m	129 lm/W
jut-out	3000K	17.6 W/m	1930 lm/m	124 lm/W
	4000K		2040 lm/m	131 lm/W
asymmetric	3000K	25.5 W/m	2580 lm/m	101 lm/W
	4000K		2730 lm/m	107 lm/W

## Accessories

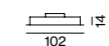

### END CAPS

TYPE	ORDER CODE
end caps (pair)	051-8991217

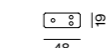

### LINEAR CONNECTOR

TYPE	ORDER CODE
linear connector (pair)	051-8990110
linear connector (10 pairs)	051-8990110.10



### DISMOUNTING TOOL

TYPE	ORDER CODE
vacuum cup	086-30000

## Light distribution

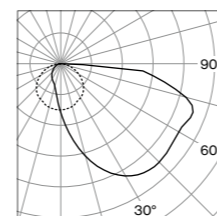

asymmetric

**LUMINOUS FLUX** value calculated for colour white, cover opal microprismatic -5%, jut-out-4%



DiiA® standards 251, 252, 253



single luminaire (p. 492)

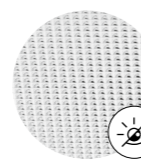

microprismatic UGR ≤ 19



quick installation

## Technical data

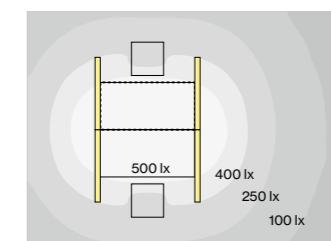

**LENO** trim, microprismatic, 19.1W, 4000K

ROOM VALUES	
Room dimensions	5.4 × 4 × 2.8 m
Reflection factor	0.7   0.5   0.2
Maintenance factor	0.8

CALCULATION SURFACE	
Surface dimensions	1.6 × 0.8
Surface height	0.75
Average illuminance (E <sub>a</sub> )	> 500 lx
Uniformity (U <sub>0</sub> )	> 0.6

GLARE EVALUATION	
Table Classification X=4H   Y=8H   S=0.25H	
UGR transversal	≤ 19
UGR axial	≤ 19

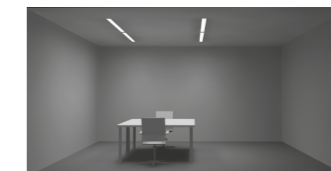



**Vaucluse House** Sydney, AU –  
by EST Lighting





← back



## LENO system

recessed trimless

**EN** Low profile recessed channel; for trimless installation in 12.5 mm plasterboard ceilings; wall or ceiling mounting; for lighting systems; powder coated; special edge design with grooves for better adhesion of filler; easy mounting without need to cut the substructure; fall-safe light inset made of extruded aluminium profile, can be inserted in the canal without tools by magnetic holders; side coupled light, directed downwards by LGP body (Light Guiding Prism) and highly efficient reflector; homogeneously illuminated, satinised (flush or jut-out) or microprismatic PMMA cover; optional asym. light distribution; energy-eff. LEDs – very good colour rendering; external converter for ceiling insertion

**IT** Apparecchio da incasso ultrapiatto; per mont. senza cornice in soffitti di cartong. 12,5 mm; montaggio a parete o soffitto; per sistemi di illuminazione; verniciatura a polvere; bordatura speciale scanalata per una migliore aderenza dello stucco; montaggio semplice senza taglio della struttura sottostante; inserto luce anti-caduta in profilo di alluminio estruso, fissaggio nel canale con magneti senza bisogno di utensili; luce convogliata lateralmente e direzionata in basso con sistema LGP-Body (Light Guiding Prism) e riflettore ad alta efficienza; diffusore satinato (a filo o sporgente) o con struttura a microprismi a illuminazione omogenea in PMMA; in opzione distribuzione asim. della luce; LED a risp. energ. – ottima resa cromatica; converter esterno da inserire nel soffitto



### Quickinfo

3000K, 4000K  
 CRI ≥ 80, 3 SDCM  
 up to 137lm/W  
 L90 @ 50 000h  
 DALI-2  
 opal, microprismatic (UGR ≤ 19),  
 jut-out, asymmetric wallwasher

### Types

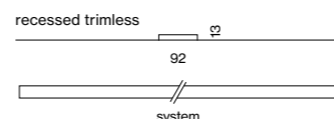

### Colour



### Light distributions

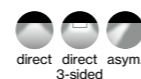

### Order options

COLOUR TEMPERATURE	
3000K	5
4000K	6

### CONTROL

DALI-2

### MATERIAL COLOUR

○ traffic white RAL 9016

### LIGHT OPTIC COVER

opal high performance	H
microprismatic (UGR ≤ 19)	G
jut-out	J
asymmetric	A

### Options on request

### COLOUR RENDERING INDEX

CRI ≥ 90

### EMERGENCY LIGHT

1h accupack  
 3h accupack

### LENO trimless

#### INSTALLATION CHANNEL

TYPE	L (mm)	ORDER CODE
channel	613	051-8900067
channel	1221	051-8900127
channel	1830	051-8900187
channel	2438	051-8900247

order installation channel, light inset + mounting accessories separately



#### LIGHT INSET

SYS. POWER (OPAL, MP, JUT-OUT / ASYM.)	L (mm)	ORDER CODE
10.8W/15.6W	612	051-8012370
19.1W/31W	1220	051-8014370
28.6W/47W	1828	051-8016370
38W/62W	2436	051-8018370

COVER	COLOUR TEMP.	SYSTEM POWER	DELIVERED LUMENS	EFFICACY
opal high	3000K	17.6 W/m	2010 lm/m	129 lm/W
performance	4000K		2130 lm/m	137 lm/W
microprismatic	3000K	17.6 W/m	1900 lm/m	122 lm/W
UGR ≤ 19	4000K		2010 lm/m	129 lm/W
jut-out	3000K	17.6 W/m	1930 lm/m	124 lm/W
	4000K		2040 lm/m	131 lm/W
asymmetric	3000K	25.5 W/m	2580 lm/m	101 lm/W
	4000K		2730 lm/m	107 lm/W

### Accessories



#### END CAPS

TYPE	ORDER CODE
end caps (pair)	051-8990217



#### LINEAR CONNECTOR

TYPE	ORDER CODE
linear connector (pair)	051-8990110
linear connector (10 pairs)	051-8990110.10



#### DISMISSING TOOL

TYPE	ORDER CODE
vacuum cup	086-30000

### Light distribution

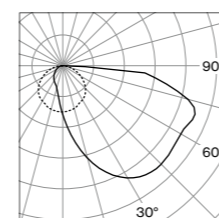

asymmetric

**LUMINOUS FLUX** value calculated for colour white, cover opal microprismatic -5%, jut-out-4%

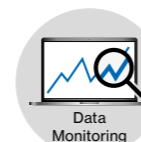

DiiA® standards  
 251, 252, 253



single luminaire  
 (p. 492)

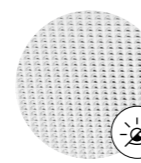

microprismatic  
 UGR ≤ 19



quick  
 installation

### Technical data

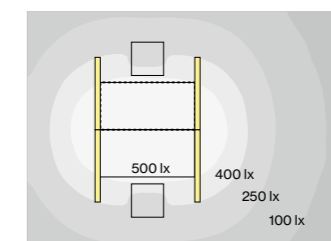

**LENO** trimless, microprismatic,  
 19.1W, 4000K

ROOM VALUES	
Room dimensions	5.4 × 4 × 2.8m
Reflection factor	0.7   0.5   0.2
Maintenance factor	0.8

CALCULATION SURFACE	
Surface dimensions	1.6 × 0.8
Surface height	0.75
Average illuminance (E <sub>av</sub> )	> 500 lx
Uniformity (U <sub>0</sub> )	> 0.6

GLARE EVALUATION	
Table Classification X=4H   Y=8H   S=0.25H	
UGR transversal	≤ 19
UGR axial	≤ 19

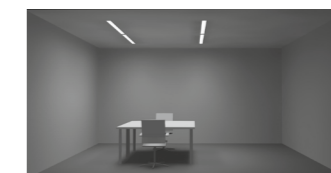

**Office Gemüsekiye**

Kramsach, AT –

by STUDIODESIGN, Herbert Lanzinger KG



← back



# LENO system

semi-recessed

Low profile recessed mounted luminaire, 15 mm visible height; suitable for wall or ceiling mounting; suitable for installation in primed or exposed concrete, in plasterboard constructions and in plastered walls or ceilings; designed for continuous lighting systems; surface powder coated; fall-safe light inset made of extruded aluminium profile, can be inserted in the canal without tools by magnetic holders; side coupled light, directed downwards by LGP body (Light Guiding Prism) and highly efficient reflector; homogeneously illuminated, satinised (flush or jut-out) or microprismatic PMMA cover; energy-efficient LEDs with very good colour rendering

Apparecchio da incasso ultrapiatto da 15 mm di altezza visibile; per montaggio a parete o soffitto; per montaggio in cemento a vista o stuccato, in costruzioni di cartongesso e in pareti o soffitti intonacati; per sistemi di file continue; verniciatura a polvere; inserto luce anti-caduta in profilo di alluminio estruso, fissaggio nel canale con magneti senza bisogno di utensili; luce convogliata lateralmente e direzionata in basso con sistema LGP-Body (Light Guiding Prism) e riflettore ad alta efficienza; diffusore satinato (a filo o sporgente) o con struttura a microprismi a illuminazione omogenea in PMMA; LED ad efficienza energetica con elevata resa cromatica

## Quickinfo

3000K, 4000K  
 CRI ≥ 80, 3 SDCM  
 up to 137lm/W  
 L90 @ 50 000h  
 DALI-2  
 opal, microprismatic (UGR ≤ 19),  
 jut-out

## Types

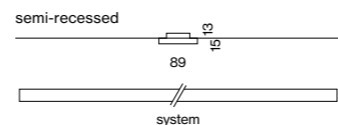

## Colours



## Light distributions



## Order options

COLOUR TEMPERATURE	
3000K	5
4000K	6

## CONTROL

DALI-2

## MATERIAL COLOUR

○ traffic white RAL 9016	7
● jet black RAL 9005	8

## LIGHT OPTIC COVER

opal high performance	H
microprismatic (UGR ≤ 19)	G
jut-out	J

## Options on request

### COLOUR RENDERING INDEX

CRI ≥ 90

## Technical data

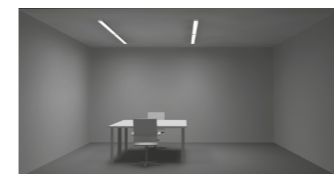
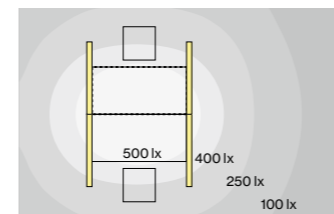

LENO semi-recessed, microprismatic, 19.1W, 4000K

ROOM VALUES	
Room dimensions	5.4 × 4 × 2.8m
Reflection factor	0.7   0.5   0.2
Maintenance factor	0.8

CALCULATION SURFACE	
Surface dimensions	1.6 × 0.8
Surface height	0.75
Average illuminance (E <sub>m</sub> )	> 500 lx
Uniformity (U <sub>0</sub> )	> 0.6

GLARE EVALUATION	
Table Classification	X=4H   Y=8H   S=0.25H
UGR transversal	≤ 19
UGR axial	≤ 19

LUMINOUS FLUX value calculated for colour white, cover opal microprismatic -5%, jut-out-4%

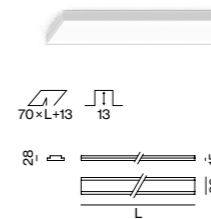

## LENO semi-recessed

### INSTALLATION CHANNEL

TYPE	L (mm)	ORDER CODE
channel	613	05 1-892006
channel	1221	05 1-892012
channel	1830	05 1-892018
channel	2438	05 1-892024

order installation channel, light inset + mounting accessories separately



### LIGHT INSET

SYSTEM POWER	L (mm)	ORDER CODE
10.8W	612*	05 1-811237
19.1W	1220	05 1-821437
28.6W	1828	05 1-821637
38W	2436	05 1-821837

\*only available as end unit

COVER	COLOUR TEMP.	SYSTEM POWER	DELIVERED LUMENS	EFFICACY
opal high performance	3000K	17.6 W/m	2010 lm/m	129 lm/W
microprismatic UGR ≤ 19	4000K	17.6 W/m	2130 lm/m	137 lm/W
jut-out	3000K	17.6 W/m	1900 lm/m	122 lm/W
	4000K	17.6 W/m	2010 lm/m	129 lm/W
	3000K	17.6 W/m	1930 lm/m	124 lm/W
	4000K	17.6 W/m	2040 lm/m	131 lm/W

## Accessories

### END CAPS

TYPE	ORDER CODE
end caps mounting housing (pair)	05 1-8996210
end caps semi-recessed	05 1-899221

### LINEAR CONNECTOR

TYPE	ORDER CODE
linear connector (pair)	05 1-8992110
linear connector (10 pairs)	05 1-8992110.10

### POWER FEEDER CONNECTOR 220-240V | 13A

TYPE	ORDER CODE
power feeder connector	05 1-8992330

### CONCRETE MOUNTING HOUSING

L (mm)	UNIT	ORDER CODE
616	end	05 1-8960060
1224	start/end	05 1-8960120
1221	middle	05 1-8961120
1833	start/end	05 1-8960180
1830	middle	05 1-8961180
2441	start/end	05 1-8960240
2438	middle	05 1-8961240

### DISMOUNTING TOOL

TYPE	ORDER CODE
vacuum cup	086-30000



DiiA® standards 251, 252, 253



single luminaire (p. 496)

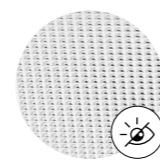

microprismatic UGR ≤ 19

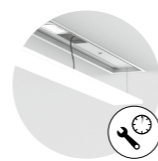

quick installation





**Jungheinrich Hauptverwaltung**  
Hamburg, DE –  
by reichardt+partner architekten



← back



# LENO system

surface

EN Low profile surface mounted luminaire, 28mm total height; suitable for wall or ceiling mounting; designed for continuous lighting systems; surface powder coated; fall-safe light inset made of extruded aluminium profile, can be inserted in the canal without tools by magnetic holders; side coupled light, directed downwards by LGP body (Light Guiding Prism) and highly efficient reflector; homogeneously illuminated, satinised (flush or jut-out) or microprismatic PMMA cover; energy-efficient LEDs with very good colour rendering

IT Apparecchio a plafone ultrapiatto da 28mm di altezza totale; per montaggio a parete o soffitto; per sistemi di file continue; verniciatura a polvere; inserto luce anti-caduta in profilo di alluminio estruso, fissaggio nel canale con magneti senza bisogno di utensili; luce convogliata lateralmente e direzionata in basso con sistema LGP-Body (Light Guiding Prism) e riflettore ad alta efficienza; diffusore satinato (a filo o sporgente) o con struttura a microprismi a illuminazione omogenea in PMMA; LED ad efficienza energetica con elevata resa cromatica



## Quickinfo

3000K, 4000K  
 CRI ≥ 80, 3 SDCM  
 up to 137lm/W  
 L90 @ 50 000h  
 DALI-2  
 opal, microprismatic (UGR ≤ 19),  
 jut-out

## Types

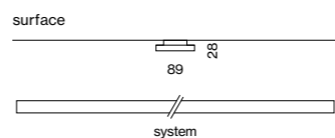

## Colours



## Light distributions



## Order options

COLOUR TEMPERATURE	
3000K	5
4000K	6

## CONTROL

DALI-2

## MATERIAL COLOUR

○ traffic white RAL 9016	7
● jet black RAL 9005	8

## LIGHT OPTIC COVER

opal high performance	H
microprismatic (UGR ≤ 19)	G
jut-out	J

## Options on request

### COLOUR RENDERING INDEX

CRI ≥ 90

## Technical data

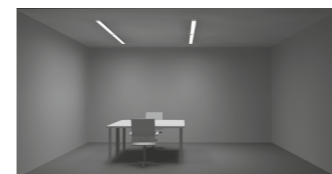
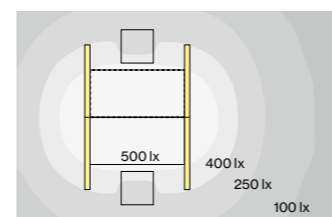

LENO surface, microprismatic,  
 19.1W, 4000K

ROOM VALUES	
Room dimensions	5.4 × 4 × 2.8 m
Reflection factor	0.7   0.5   0.2
Maintenance factor	0.8

CALCULATION SURFACE .....	
Surface dimensions	1.6 × 0.8
Surface height	0.75
Average illuminance (E <sub>m</sub> )	> 500 lx
Uniformity (U <sub>0</sub> )	> 0.6

GLARE EVALUATION	
Table Classification X=4H   Y=8H   S=0.25H	
UGR transversal	≤ 19
UGR axial	≤ 19

LUMINOUS FLUX value calculated for  
 colour white, cover opal  
 microprismatic -5%, jut-out-4%

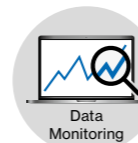

DiiA® standards  
 251, 252, 253



single luminaire  
 (p. 500)

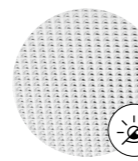

microprismatic  
 UGR ≤ 19

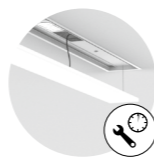

quick  
 installation

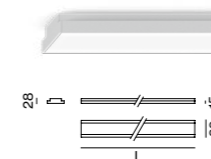

## LENO surface

### INSTALLATION CHANNEL

TYPE	L (mm)	ORDER CODE
channel	613	05 1-892006
channel	1221	05 1-892012
channel	1830	05 1-892018
channel	2438	05 1-892024

order installation channel, light inset + mounting accessories separately



### LIGHT INSET

SYSTEM POWER	L (mm)	ORDER CODE
10.8W	612*	05 1-811237
19.1W	1220	05 1-821437
28.6W	1828	05 1-821637
38W	2436	05 1-821837

\*only available as end unit

COVER	COLOUR TEMP.	SYSTEM POWER	DELIVERED LUMENS	EFFICACY
opal high	3000 K	17.6 W/m	2010 lm/m	129 lm/W
performance	4000 K		2130 lm/m	137 lm/W
microprismatic	3000 K	17.6 W/m	1900 lm/m	122 lm/W
UGR ≤ 19	4000 K		2010 lm/m	129 lm/W
jut-out	3000 K	17.6 W/m	1930 lm/m	124 lm/W
	4000 K		2040 lm/m	131 lm/W

## Accessories

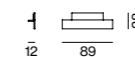

### END CAPS

TYPE	ORDER CODE
end caps (pair)	05 1-899221



### LINEAR CONNECTOR

TYPE	ORDER CODE
linear connector (pair)	05 1-8992110
linear connector (10 pairs)	05 1-8992110.10

### POWER FEEDER CONNECTOR 220-240V | 13A

TYPE	ORDER CODE
power feeder connector	05 1-8992330



### DISMOUNTING TOOL

TYPE	ORDER CODE
vacuum cup	086-30000

← back



## LENO system

suspended

Low profile suspended luminaire, 28 mm total height; pendant fitting with cable suspension; with integrated tool-less suspension height adjustment; incl. transparent feed; designed for continuous lighting systems; surface powder coated; fall-safe light inset made of extruded aluminium profile, can be inserted in the canal without tools by magnetic holders; side coupled light, directed downwards by LGP body (Light Guiding Prism) and highly efficient reflector; homogeneously illuminated, satinised (flush or jut-out) or microprismatic PMMA cover; energy-efficient LEDs with very good colour rendering

Apparecchio a sospensione ultrapiatto da 28 mm di altezza totale; sospeso con cavo a sospensione; altezza regolabile sull'apparecchio, senza utensili; incl. cavo di alimentazione trasparente; per sistemi di file continue; verniciatura a polvere; inserto luce anti-caduta in profilo di alluminio estruso, fissaggio nel canale con magneti senza bisogno di utensili; luce convogliata lateralmente e direzionata in basso con sistema LGP-Body (Light Guiding Prism) e riflettore ad alta efficienza; diffusore satinato (a filo o sporgente) o con struttura a microprismi a illuminazione omogenea in PMMA; LED ad efficienza energetica con elevata resa cromatica

### Quickinfo

3000K, 4000K  
CRI ≥ 80, 3 SDCM  
up to 137lm/W  
L90 @ 50 000h  
DALI-2  
opal, microprismatic (UGR ≤ 19),  
jut-out

### Types

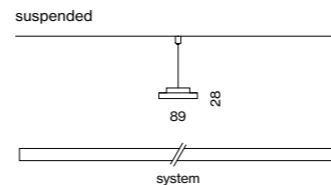

### Colours



### Light distributions



### Order options

COLOUR TEMPERATURE	
3000K	5
4000K	6

### CONTROL

DALI-2

### MATERIAL COLOUR

○ traffic white RAL 9016	7
● jet black RAL 9005	8

### LIGHT OPTIC COVER

opal high performance	H
microprismatic (UGR ≤ 19)	G
jut-out	J

### Options on request

#### COLOUR RENDERING INDEX

CRI ≥ 90

### Technical data

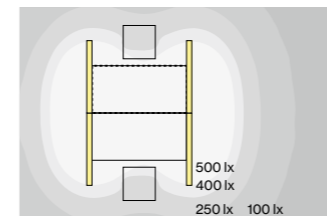

LENO suspended, microprismatic,  
19.1W, 4000K

#### ROOM VALUES

Room dimensions	5.4 × 4 × 2.8 m
Reflection factor	0.7   0.5   0.2
Maintenance factor	0.8
Mounting height	2.25 m

#### CALCULATION SURFACE

Surface dimensions	1.6 × 0.8
Surface height	0.75
Average illuminance (E <sub>m</sub> )	> 500 lx
Uniformity (U <sub>0</sub> )	> 0.6

#### GLARE EVALUATION

Table Classification X=4H   Y=8H   S=0.25H	
UGR transversal	≤ 19
UGR axial	≤ 19

LUMINOUS FLUX value calculated for  
colour white, cover opal  
microprismatic -5%, jut-out-4%

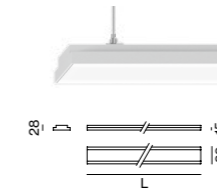

### LENO suspended

#### INSTALLATION CHANNEL

TYPE	L (mm)	ORDER CODE
channel	613	051-893006
channel	1221	051-893012
channel	1830	051-893018
channel	2438	051-893024

order installation channel, light inset + mounting accessories separately



#### LIGHT INSET

SYSTEM POWER	L (mm)	ORDER CODE
10.8W	612*	051-811237
19.1W	1220	051-821437
28.6W	1828	051-821637
38W	2436	051-821837

\*only available as end unit

COVER	COLOUR TEMP.	SYSTEM POWER	DELIVERED LUMENS	EFFICACY
opal high performance	3000K	17.6W/m	2010lm/m	129lm/W
microprismatic	4000K	17.6W/m	2130lm/m	137lm/W
UGR ≤ 19	3000K	17.6W/m	1900lm/m	122lm/W
jut-out	4000K	17.6W/m	2010lm/m	129lm/W
	4000K	17.6W/m	1930lm/m	124lm/W
	4000K	17.6W/m	2040lm/m	131lm/W

### Accessories

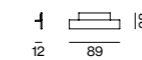

#### END CAPS

TYPE	ORDER CODE
end caps (pair)	051-899221

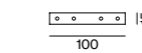

#### LINEAR CONNECTOR

TYPE	ORDER CODE
linear connector (pair)	051-8993110
linear connector (10 pairs)	051-8993110.10

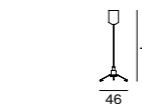

#### CABLE SUSPENSION

L (mm)	ORDER CODE
1500	005-2122110

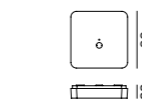

#### CANOPY / CABLE RAIL

TYPE	L (mm)	ORDER CODE
canopy / feeder cable 5 × 1.5 mm <sup>2</sup>	1500	005-221241
cable rail	1200	005-2491110

for electrical system configuration see luminaire data sheet at xal.com

#### POWER FEEDER CONNECTOR 220-240V | 13A

TYPE	ORDER CODE
power feeder connector	051-8992330



#### DISMOUNTING TOOL

TYPE	ORDER CODE
vacuum cup	086-30000

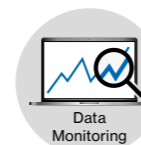

DiiA® standards  
251, 252, 253



single luminaire  
(p. 504)

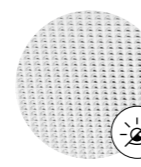

microprismatic  
UGR ≤ 19

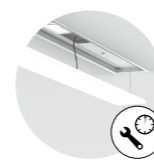

quick  
installation

# Sharpen your profile system

## MINIMAL system

**EN** A minimalist, continuous lighting system with maximum design freedom – MINIMAL makes this combination possible. The system luminaire is rimless, can be varied in length and thus be individually combined. CORNER elements create the perfect connection between the individual system luminaires. Designed for indoor use, the microprismatic cover version offers a standard-compliant reduced glare value for ideal workplace lighting. When using the opal cover, homogeneous room illumination is achieved, whereas the wallwasher insert provides uniform wall illumination. The MINIMAL system luminaire is available in the light colours 3000K, 4000K, and optionally in Tunable White.

**IT** Un sistema d'illuminazione minimalista e unitario, con il massimo della libertà compositiva: sono queste le prerogative di MINIMAL. L'apparecchio in sistema, senza cornice, può variare di lunghezza in modo da formare combinazioni individuali. Gli elementi CORNER servono a collegare perfettamente i singoli apparecchi. Il sistema studiato per ambienti interni offre una variante con rifrattore a microprismi che riduce l'abbagliamento illuminando le postazioni di lavoro in conformità alle normative. I rifrattori opali servono invece ad assicurare un'illuminazione generale omogenea, mentre gli elementi wallwasher diffondono una luminosità uniforme sulle pareti. Per l'apparecchio in sistema MINIMAL sono previste le tonalità 3000K, 4000K e l'opzione Tunable White.

### Types



60

100

### Mounting

trimless  
recessed

### Configurations



linear

corner

### Light distributions

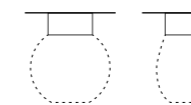

opal

microprismatic  
(UGR ≤ 19)

← back



## MINIMAL 60 system

recessed trimless

EN Luminaire housing made of extruded aluminium; for trimless installation in plasterboard ceilings; special edge design with grooves for better adhesion of filler; for continuous lighting systems; for ceiling thickness of 8-25mm; surface powder coated; luminaire profile for mounting available in advance; remaining components mounted without tools; light inset consisting of highly reflective coated extruded profile for improved thermal management; option: lighting module is versatile in length; HPO (High Performance Opal) cover for uniform illumination; micro prismatic PMMA diffuser incl. diffuser film for homogeneous illumination and reduced luminance; wallwasher light inset; energy-eff. LEDs – very good colour rendering

IT Corpo illuminante in profilo di alluminio estruso; incasso a scomparsa in soffitti di cartongesso; bordatura speciale scanalata per una migliore aderenza dello stucco; per file continue; per soffitti di spessore 8-25 mm; verniciatura a polvere; profilo consegnabile in anticipo; tutti gli altri componenti si fissano senza bisogno di utensili; unità d'illuminazione in profilo di alluminio estruso con verniciatura altamente riflettente per gestione termica migliorata; in opzione unità luminosa accorciabile con flessibilità; diffusore HPO (High Performance Opal) per un'illuminazione omogenea; rifrattore in PMMA a microprismi incl. pellicola di diffusione per ridurre la luminanza mantenendo l'illuminazione omogenea; inserto luminoso wallwasher; LED a risp. energ. – ottima resa cromatica

### Quickinfo

3000K, 4000K, TW  
 CRI ≥ 80, CRI ≥ 90, 3 SDCM  
 up to 2760 lm/m  
 up to 125 lm/W  
 L90 @ 50 000h  
 non DIM, DALI-2  
 opal, microprismatic (UGR ≤ 19)

### Types

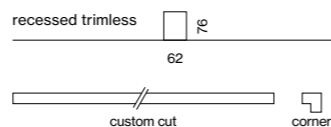

### Colour



### Light distributions



micropr. opal

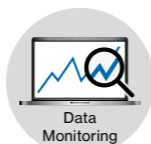

DiiA® standards  
 251, 252, 253

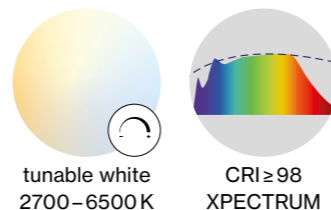
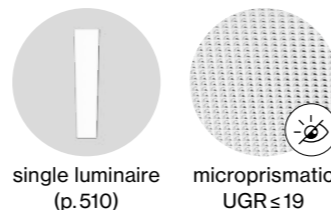

### Order options

LED TYPE	
mid lumen	L
high lumen	M

COLOUR TEMPERATURE	
3000K (CRI ≥ 90)	0
4000K (CRI ≥ 90)	1
3000K (CRI ≥ 80)	5
4000K (CRI ≥ 80)	6
tunable white 2700-6500K*	

\*DALI-2 DT8

CONTROL	
non DIM	1
DALI-2 (only high lumen)	3

### MATERIAL COLOUR

○ traffic white RAL 9016

### LIGHT OPTIC COVER

opal high performance	H
microprismatic	Z
microprismatic (UGR ≤ 19)*	G
blind cover**	B

\*UGR ≤ 19 only with mid lumen

\*\*only for channel corner 90°

### EMERGENCY LIGHT

1h Accupack	N L 1
3h Accupack	N L 3

### Options on request

#### COLOUR RENDERING INDEX

CRI ≥ 98 XPECTRUM

LUMINOUS FLUX value calculated for CRI ≥ 80, colour white, cover opal microprismatic -13%

### MINIMAL 60 trimless

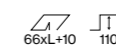

#### INSTALLATION CHANNEL / CORNER 90°

TYPE	L (mm)	ORDER CODE
channel	1172	036-01247
channel	1472	036-01547
channel	3000	036-03047
channel	custom	E82030...7
channel corner 90° + cover	140x140	036-12647

#### LIGHT OPTIC COVER / BLIND COVER

TYPE	L (mm)	ORDER CODE
linear	1171	006-16122
linear	1470	006-16152
linear	2997	006-16302
linear	custom	E80630...0
continuous linear	6000	006-23061H
continuous linear	25000	006-23251H
blind cover	3000	006-18307
blind cover	custom	E80630...7B



#### LIGHT INSET 60

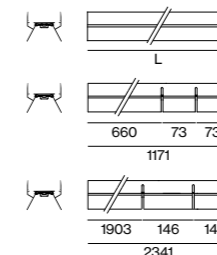

SYSTEM POWER (MID / HIGH LUMEN)	L (mm)	ORDER CODE
8.7 / 13.8 W	571	007-93...2
13 / 20.6 W	871	007-93...3
15.3 / 27.5 W	1171	007-93...4
19.2 / 34 W	1463	007-93...5
31 / 55 W	2341	007-93...8
38 / 68 W	2997	007-93...9
flexible inset 15.3 / 27.5 W	660-1171	007-93...F
flexible inset 31 / 55 W	1903-2341	007-93...G

COVER	COLOUR TEMP.	SYSTEM POWER	DELIVERED LUMENS	EFFICACY
mid lumen / opal	3000K	14 W/m	1540 lm/m	118 lm/W
high performance	4000K		1640 lm/m	125 lm/W
high lumen / opal	3000K	24 W/m	2540 lm/m	110 lm/W
high performance	4000K		2700 lm/m	116 lm/W

#### LIGHT INSET 60 tunable white 2700-6500K

SYSTEM POWER	L (mm)	ORDER CODE
21.7 W	871	007-9333D37
29 W	1171	007-9334D37
36 W	1463	007-9335D37
58 W	2341	007-9338D37

### Accessories



#### END CAPS

TYPE	ORDER CODE
end caps (pair)	036-13047

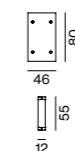

#### LINEAR CONNECTOR / THROUGH WIRE

TYPE	ORDER CODE
linear connector (1 piece)	005-40046
linear connector (10 pieces)	005-40046.10
opal cover linear connector	006-14000
through wire 3 × 1.5 mm <sup>2</sup> (non DIM, 10 pieces)	004-90003
through wire 5 × 1.5 mm <sup>2</sup> (DALI-2, 10 pieces)	004-90005

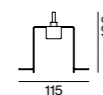

#### MOUNTING BRACKET

TYPE	CEILING THICKNESS (mm)	ORDER CODE
mounting bracket (1 piece)	8-25	036-10200
mounting bracket (25 pieces)	8-25	036-10200.25

number of brackets required: length of your system in metres+1



← back

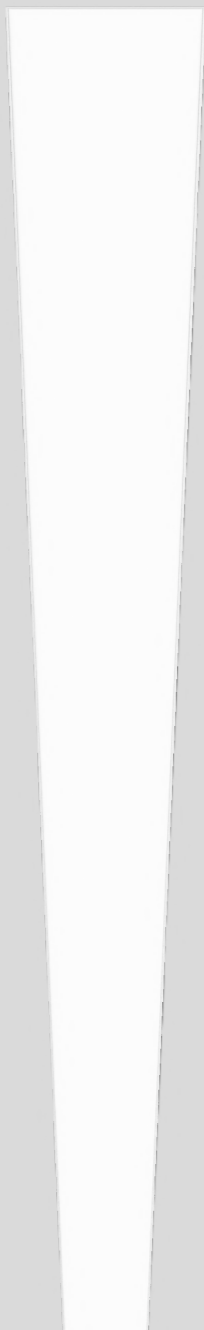

## MINIMAL 100 system

recessed trimless

EN Luminaire housing made of extruded aluminium; for trimless installation in plasterboard ceilings; special edge design with grooves for better adhesion of filler; for continuous lighting systems; for ceiling thickness of 8-25mm; surface powder coated; luminaire profile for mounting available in advance; remaining components mounted without tools; light inset consisting of highly reflective coated extruded profile for improved thermal management; option: lighting module is versatile in length; HPO (High Performance Opal) cover for uniform illumination; micro prismatic PMMA diffuser incl. diffuser film for homogeneous illumination and reduced luminance; wallwasher light inset; energy-eff. LEDs – very good colour rendering

IT Corpo illuminante in profilo di alluminio estruso; incasso a scomparsa in soffitti di cartongesso; bordatura speciale scanalata per una migliore aderenza dello stucco; per file continue; per soffitti di spessore 8-25mm; verniciatura a polvere; profilo consegnabile in anticipo; tutti gli altri componenti si fissano senza bisogno di utensili; unità d'illuminazione in profilo di alluminio estruso con verniciatura altamente riflettente per gestione termica migliorata; in opzione unità luminosa accorciabile con flessibilità; diffusore HPO (High Performance Opal) per un'illuminazione omogenea; rifrattore in PMMA a microprismi incl. pellicola di diffusione per ridurre la luminanza mantenendo l'illuminazione omogenea; inserto luminoso wallwasher; LED a risp. energ. – ottima resa cromatica

### Quickinfo

3000K, 4000K, TW  
 CRI ≥ 80, CRI ≥ 90, 3 SDCM  
 UGR ≤ 19 / 65° ≤ 3000 cd/m²  
 up to 3090 lm/m  
 up to 140 lm/W  
 L90 @ 50 000h  
 non DIM, DALI-2  
 opal, microprismatic (UGR ≤ 19)

### Types

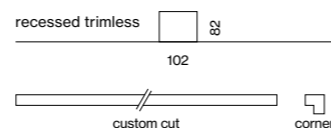

### Colour



### Light distributions

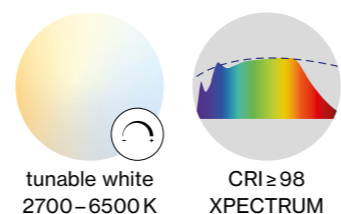
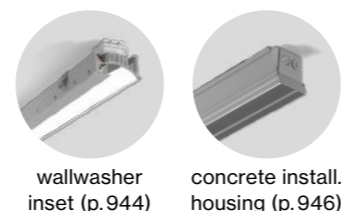
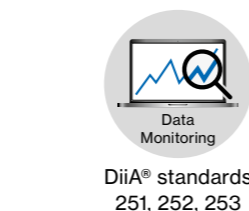

### Order options

LED TYPE	
mid lumen	L
high lumen	M

COLOUR TEMPERATURE	
3000K (CRI ≥ 90)	0
4000K (CRI ≥ 90)	1
3000K (CRI ≥ 80)	5
4000K (CRI ≥ 80)	6
tunable white 2700–6500K*	

\*DALI-2 DT8

CONTROL	
non DIM	1
DALI-2 (only high lumen)	3

MATERIAL COLOUR	
traffic white RAL 9016	

LIGHT OPTIC COVER	
opal high performance	H
microprismatic	Z
microprismatic (UGR ≤ 19)*	G
blind cover**	B

\*UGR ≤ 19 only with mid lumen  
 \*\*only for channel corner 90°

EMERGENCY LIGHT	
1h Accupack	N L 1
3h Accupack	N L 3

### Options on request

COLOUR RENDERING INDEX	
CRI ≥ 98 XPECTRUM	

LUMINOUS FLUX value calculated for CRI ≥ 80, colour white, cover opal microprism. Z -8%, microprism. G -10%

### MINIMAL 100 trimless

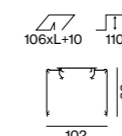

INSTALLATION CHANNEL / CORNER 90°	L (mm)	ORDER CODE
channel	1172	036-01267
channel	1472	036-01567
channel	3000	036-03067
channel	custom	E82050...7
channel corner 90° + cover	200x200	036-12667

LIGHT OPTIC COVER / BLIND COVER	L (mm)	ORDER CODE
linear	1171	006-12122
linear	1470	006-12152
linear	2997	006-12302
linear	custom	E80650...0
blind cover	3000	006-11307
blind cover	custom	E80650...7B

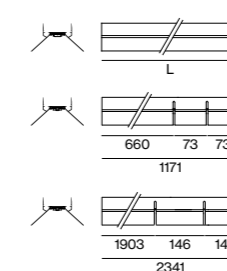

LIGHT INSET 100	SYSTEM POWER (MID/HIGH LUMEN)	L (mm)	ORDER CODE
	8.7 / 13.8 W	571	007-86...2
	13 / 20.6 W	871	007-86...3
	15.3 / 27.5 W	1171	007-86...4
	19.2 / 34 W	1463	007-86...5
	31 / 55 W	2341	007-86...8
	38 / 68 W	2997	007-86...9
	flexible inset 15.3 / 27.5 W	660-1171	007-86...F
	flexible inset 31 / 55 W	1903-2341	007-86...G

COVER	COLOUR TEMP.	SYSTEM POWER	DELIVERED LUMENS	EFFICACY
mid lumen / opal	3000K	14 W/m	1770 lm/m	132 lm/W
high performance	4000K		1870 lm/m	140 lm/W
high lumen / opal	3000K	24 W/m	2920 lm/m	123 lm/W
high performance	4000K		3090 lm/m	130 lm/W

LIGHT INSET 100 tunable white 2700–6500K	SYSTEM POWER	L (mm)	ORDER CODE
	21.7 W	871	007-8633D37
	29 W	1171	007-8634D37
	36 W	1463	007-8635D37
	58 W	2341	007-8638D37

### Accessories

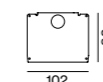

END CAPS	ORDER CODE
end caps (pair)	036-13067

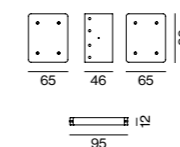

LINEAR CONNECTOR / THROUGH WIRE	ORDER CODE
linear connector (1 piece)	005-40066
linear connector (10 pieces)	005-40066.10
opal cover linear connector	006-10000
through wire 3 × 1.5 mm² (non DIM, 10 pieces)	004-90003
through wire 5 × 1.5 mm² (DALI-2, 10 pieces)	004-90005

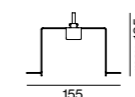

MOUNTING BRACKET	CEILING THICKNESS (mm)	ORDER CODE
mounting bracket (1 piece)	8-25	036-10300
mounting bracket (25 pieces)	8-25	036-10300.25

number of brackets required: length of your system in metres+1

**Bank of Ireland** Dublin, IE –  
by Henry J Lyons Architects with lighting  
design by O'Connor Sutton Cronin





**Telecable**  
Gijón, ES –  
by Arquitectos  
Pablo Poch Duo Comunicación with  
lighting design by Lux Gijón



# Outline your profile system

## FRAME system

**EN** The FRAME system luminaire sets no limits on office lighting and profile-based ambient lighting. Thanks to special flex insets, FRAME can be shortened on-site and thus adapted to all conditions. The system luminaire connects to form a light band, creating continuous lighting. Corner connectors thus create a continuous lighting system. The lighting insets also leave nothing to be desired – whether insets with opal cover for uniform room illumination, or the microprismatic cover for light suitable for workplaces. Available light colours range from 3000 K to 4000 K and optional Tunable White, and a colour rendering of up to  $\text{CRI} \geq 98$  (XPECTRUM).

**IT** Con gli apparecchi FRAME in sistema non ci sono limiti a una perfetta illuminazione generale di uffici realizzata con profili. Gli appositi inserti flessibili di FRAME si accorciano sul posto in modo da adattarsi ad ogni contesto specifico. Gli apparecchi si uniscono in fila continua formando un'illuminazione ininterrotta che non manca di giunti angolari. La stessa scelta di inserti non lascia nulla a desiderare: rifrattori opali per un'illuminazione generale unitaria, oppure rifrattori a microprismi per una luce adatta alle postazioni di lavoro. Le tonalità previste sono 3000 K, 4000 K, a scelta anche Tunable White, con resa cromatica che arriva a  $\text{CRI} \geq 98$  (XPECTRUM).

### Types



40

60

100

### Mounting



with trim  
recessed

### Configurations



linear

corner

### Light distributions

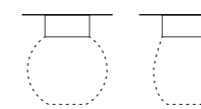

opal

 microprismatic  
( $\text{UGR} \leq 19$ )

← back



## FRAME 40 system

recessed with trim

**EN** Luminaire housing made of extruded aluminium; recessed luminaire with trim; designed for continuous lighting systems; suitable for ceiling thickness of 8-25mm; surface powder coated; luminaire profile incl. light inset; cover in the length of the light inset or continuous cover (both separately available); pre-assembled power rail for power supply in luminaire profile; voltage tap of the light inset on the power rail; light inset consisting of highly reflective coated extruded profile for improved thermal management; HPO (High Performance Opal) cover for uniform illumination; energy-efficient LEDs with very good colour rendering

**IT** Corpo illuminante in profilo di alluminio estruso; apparecchio da incasso con bordo perimetrale; per sistemi di file continue; per soffitti di spessore 8-25mm; verniciatura a polvere; profilo con inserto luminoso; cover della lunghezza dell'inserto luminoso o continua (entrambe da ordinare separ.); binario elettrificato premontato per l'alimentazione nel profilo; presa di tens. per inserto lum. sul binario elettr.; unità d'illuminazione in profilo di alluminio estruso con verniciatura altamente riflettente per gestione termica migliorata; diffusore HPO (High Performance Opal) per un'illuminazione omogenea; LED ad efficienza energetica con elevata resa cromatica

### Quickinfo

3000K, 4000K  
 CRI ≥ 90, 3 SDCM  
 up to 2340lm/m  
 up to 102lm/W  
 L90 @ 50 000h  
 DALI-2  
 opal

### Types

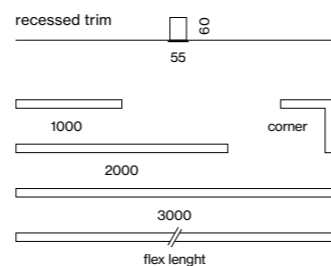

### Colours



### Light distribution



opal

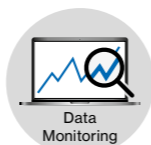

DiiA® standards  
 251, 252, 253



single luminaire  
 (p. 518)



flexible  
 inset

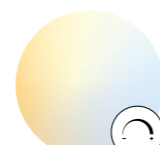

tunable white  
 2700–6500K

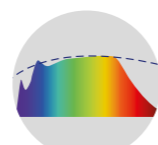

CRI ≥ 98  
 XPECTRUM

### Order options

LED TYPE	
mid lumen	1
high lumen	2

COLOUR TEMPERATURE	
3000K	0
4000K	1

CONTROL	
DALI-2	

MATERIAL COLOUR	
○ traffic white RAL 9016	7
● white aluminium RAL 9006	G

LIGHT OPTIC COVER	
opal high performance	

### Options on request

COLOUR RENDERING INDEX	
CRI ≥ 98 XPECTRUM	

COLOUR TEMPERATURE	
tunable white 2700–6500K	

LIGHT OPTIC COVER	
microprismatic	

### FRAME 40 trim

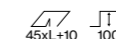

### INSTALLATION CHANNEL + LIGHT INSET

SYSTEM POWER (MID/HIGH LUMEN)	L (mm)	ORDER CODE
15.3/22.9W	1000	042-70▲2::3
30.5/46W	2000	042-70▲4::3
46/69W	3000	042-70▲6::3
15.3/22.9W flex	500–1000	042-70▲F::3
30.5/46W flex	1500–2000	042-70▲G::3
15.3/22.9W corner	500×500	042-70▲C::3

COVER	COLOUR TEMP.	SYSTEM POWER	DELIVERED LUMENS	EFFICACY
mid lumen / opal	3000K	15.3W/m	1480lm/m	97lm/W
high performance	4000K		1560lm/m	102lm/W
high lumen / opal	3000K	22.9W/m	2210lm/m	97lm/W
high performance	4000K		2340lm/m	102lm/W

### LIGHT OPTIC COVER 40

TYPE	L (mm)	ORDER CODE
linear	1000	006-4210010H
linear	2000	006-4220010H
linear	3000	006-4230010H
corner	500×500	006-4205020H
continuous linear	6000	006-2206010H
continuous linear	30000	006-2230010H

### Accessories

#### END CAPS

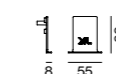

TYPE	ORDER CODE
end caps (pair)	042-709001

#### CHANNEL + BLIND COVER

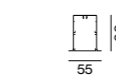

TYPE	L (mm)	ORDER CODE
linear	1000	042-709421
linear	2000	042-709441
linear	3000	042-709461
corner	500×500	042-7094C1

#### POWER FEEDER UNIT

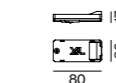

TYPE	ORDER CODE
power feeder unit	042-1093230

#### LINEAR CONNECTOR

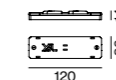

TYPE	ORDER CODE
mechanical linear connector	042-7091110
mechanical + electrical linear connector	042-7091230
opal cover linear connector	042-1091910

#### MOUNTING BRACKET

TYPE	CEILING THICKNESS (mm)	ORDER CODE
mounting bracket (1 piece)	8-25	042-7092110
mounting bracket (25 pieces)	8-25	042-7092110.25

number of brackets required: length of your system in metres+1

**LUMINOUS FLUX** value calculated for CRI ≥ 90, colour white, cover opal

← back



## FRAME 60 system

recessed with trim

EN Luminaire housing made of extruded aluminium; recessed luminaire with trim; designed for continuous lighting systems; suitable for ceiling thickness of 8-25 mm; surface powder coated; luminaire profile for mounting available in advance; remaining luminaire components mounted without tools; light inset consisting of highly reflective coated extruded profile for improved thermal management; option: lighting module is versatile in length; HPO (High Performance Opal) cover for uniform illumination; micro prismatic PMMA diffuser incl. diffuser film for homogeneous illumination and reduced luminance; wall-washer light inset; energy-efficient LEDs with very good colour rendering

IT Corpo illuminante in profilo di alluminio estruso; apparecchio da incasso con bordo perimetrale; per sistemi di file continue; per soffitti di spessore 8-25 mm; verniciatura a polvere; profilo consegnabile in anticipo; restanti componenti montabili senza utensili; unità d'illuminazione in profilo di alluminio estruso con verniciatura altamente riflettente per gestione termica migliorata; in opzione unità luminosa accorciabile con flessibilità; diffusore HPO (High Performance Opal) per un'illuminazione omogenea; rifrattore in PMMA a microprismi incl. pellicola di diffusione per ridurre la luminanza mantenendo l'illuminazione omogenea; inserto luminoso wallwasher; LED ad efficienza energetica con elevata resa cromatica

### Quickinfo

3000K, 4000K, TW  
 CRI ≥ 80, CRI ≥ 90, 3 SDCM  
 up to 2760 lm/m  
 up to 125 lm/W  
 L90 @ 50 000h  
 non DIM, DALI-2  
 opal, microprismatic (UGR ≤ 19)

### Types

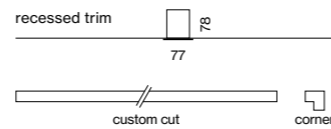

### Colours



### Light distributions



DiiA® standards  
251, 252, 253



single luminaire  
(p. 520)



wallwasher  
inset (p. 944)

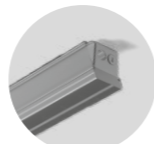

concrete install.  
housing (p. 946)



flexible  
inset

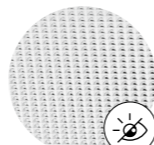

microprismatic  
UGR ≤ 19

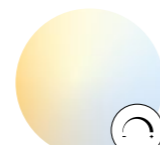

tunable white  
2700-6500K

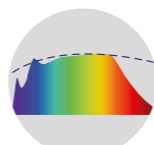

CRI ≥ 98  
XPECTRUM

### Order options

LED TYPE	
mid lumen	L
high lumen	M

COLOUR TEMPERATURE	
3000K (CRI ≥ 90)	0
4000K (CRI ≥ 90)	1
3000K (CRI ≥ 80)	5
4000K (CRI ≥ 80)	6
tunable white 2700-6500K*	

\*DALI-2 DT8

CONTROL	
non DIM	1
DALI-2 (only high lumen)	3

MATERIAL COLOUR	
○ traffic white RAL 9016	7
● white aluminium RAL 9006	G

LIGHT OPTIC COVER	
opal high performance	H
microprismatic	Z
microprismatic (UGR ≤ 19)*	G
blind cover**	B

\*UGR ≤ 19 only with mid lumen  
 \*\*only for channel corner 90°

EMERGENCY LIGHT	
1h Accupack	N L 1
3h Accupack	N L 3

### Options on request

COLOUR RENDERING INDEX	
CRI ≥ 98 XPECTRUM	

INSTALLATION CHANNEL	
curve	

CONNECTOR	
X- and T-connector	

LUMINOUS FLUX value calculated for CRI ≥ 80, colour white, cover opal microprismatic -13%

### FRAME 60 trim

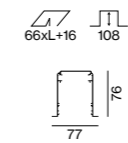

INSTALLATION CHANNEL / CORNER 90°	L (mm)	ORDER CODE
channel	1172	035-0123
channel	1472	035-0153
channel	3000	035-0303
channel	custom	E82140
channel corner 90° + cover	144x144	035-1263

LIGHT OPTIC COVER / BLIND COVER	L (mm)	ORDER CODE
linear	1171	006-16122
linear	1470	006-16152
linear	2997	006-16302
linear	custom	E80630
continuous linear	6000	006-23061H
continuous linear	25000	006-23251H
blind cover	3000	006-1830
blind cover	custom	E80630

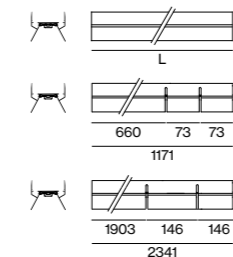

LIGHT INSET 60	L (mm)	ORDER CODE
SYSTEM POWER (MID/HIGH LUMEN)		
8.7 / 13.8 W	571	007-932
13 / 20.6 W	871	007-933
15.3 / 27.5 W	1171	007-934
19.2 / 34 W	1463	007-935
31 / 55 W	2341	007-938
38 / 68 W	2997	007-939
flexible inset 15.3 / 27.5 W	660-1171	007-93F
flexible inset 31 / 55 W	1903-2341	007-93G

COVER	COLOUR TEMP.	SYSTEM POWER	DELIVERED LUMENS	EFFICACY
mid lumen / opal	3000K	14 W/m	1540 lm/m	118 lm/W
high performance	4000K		1640 lm/m	125 lm/W
high lumen / opal	3000K	24 W/m	2540 lm/m	110 lm/W
high performance	4000K		2700 lm/m	116 lm/W

LIGHT INSET 60 tunable white 2700-6500K	L (mm)	ORDER CODE
SYSTEM POWER		
21.7 W	871	007-9333D37
29 W	1171	007-9334D37
36 W	1463	007-9335D37
58 W	2341	007-9338D37

### Accessories

END CAPS	ORDER CODE
TYPE	
end caps (pair)	035-1313

LINEAR CONNECTOR / THROUGH WIRE	ORDER CODE
TYPE	
linear connector (1 piece)	005-40046
linear connector (10 pieces)	005-40046.10
opal cover linear connector	006-14000
through wire 3 × 1.5 mm <sup>2</sup> (non DIM, 10 pieces)	004-90003
through wire 5 × 1.5 mm <sup>2</sup> (DALI-2, 10 pieces)	004-90005

MOUNTING BRACKET	CEILING THICKNESS (mm)	ORDER CODE
TYPE		
mounting bracket (1 piece)	8-25	035-10200
mounting bracket (25 pieces)	8-25	035-10200.25

number of brackets required: length of your system in metres+1



**Dr. Schaer** Burgstall, IT –  
by monovolume architecture+design  
with lighting design by VON LUTZ -  
electrical and lighting projects /  
Alexa von Lutz

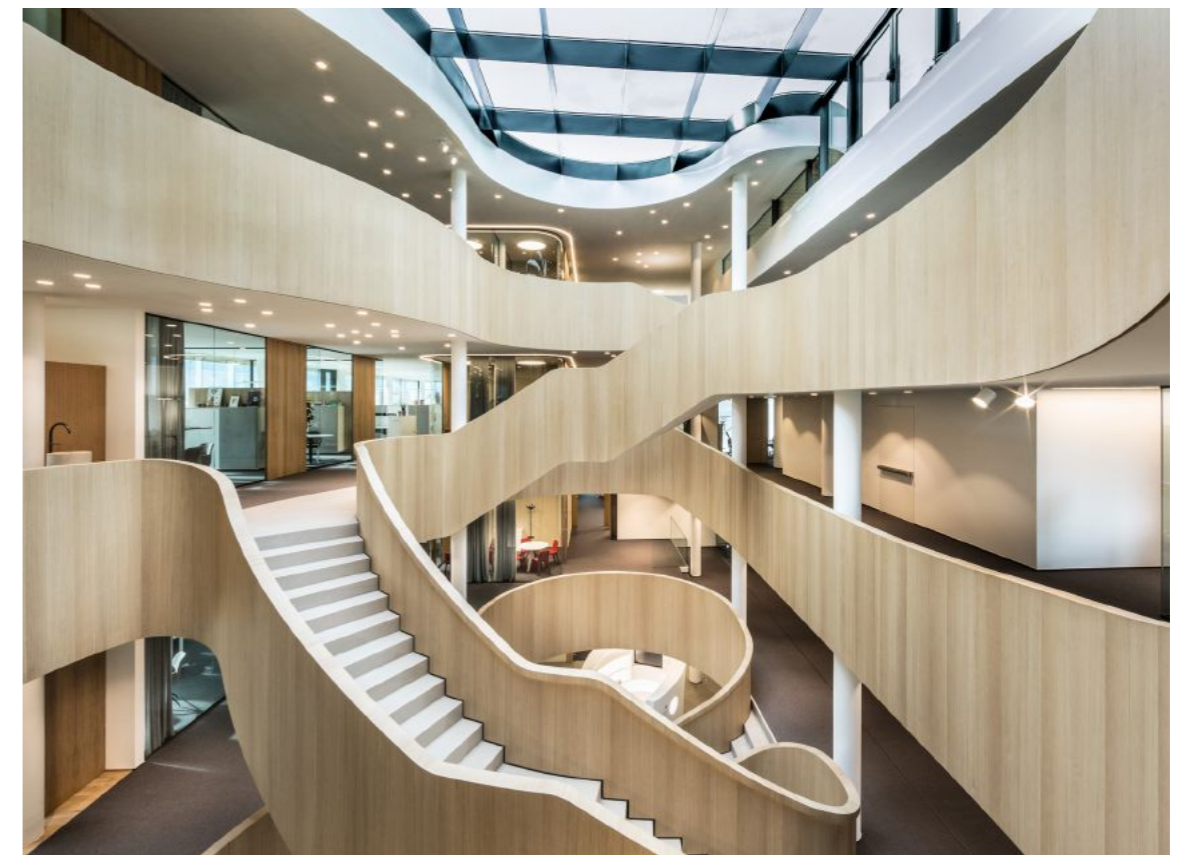
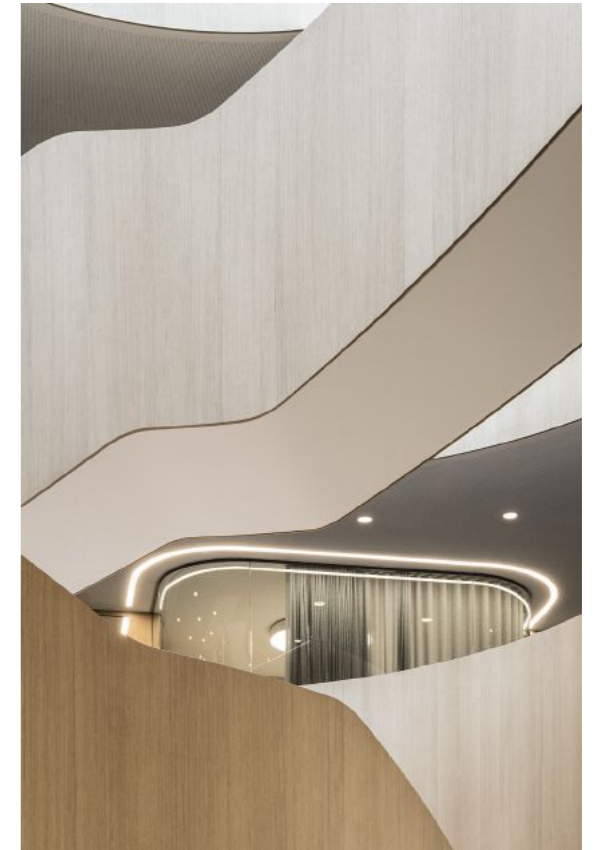

**RLB headquarters** Graz, AT –  
by Strohecker ZT GmbH with lighting  
design by Klaus Elektro-Anlagen





← back



## FRAME 100 system

recessed with trim

EN Luminaire housing made of extruded aluminium; recessed luminaire with trim; for continuous lighting systems; for ceiling thickness of 8-25 mm; surface powder coated; luminaire profile for mounting available in advance; remaining luminaire components mounted without tools; light inset consisting of highly reflective coated extruded profile for improved thermal management; option: lighting module is versatile in length; HPO (High Performance Opal) cover for uniform illumination; micro prismatic PMMA diffuser incl. diffuser film for homogeneous illumination and reduced luminance; wallwasher light inset; energy-efficient LEDs with very good colour rendering

IT Corpo illuminante in profilo di alluminio estruso; apparecchio da incasso con bordo perimetrale; per sistemi di file continue; per soffitti di spessore 8-25 mm; verniciatura a polvere; profilo consegnabile in anticipo; restanti componenti montabili senza utensili; unità d'illuminazione in profilo di alluminio estruso con verniciatura altamente riflettente per gestione termica migliorata; in opzione unità luminosa accorciabile con flessibilità; diffusore HPO (High Performance Opal) per un'illuminazione omogenea; rifrattore in PMMA a microprismi incl. pellicola di diffusione per ridurre la luminanza mantenendo l'illuminazione omogenea; inserto luminoso wallwasher; LED ad efficienza energetica con elevata resa cromatica

### Quickinfo

3000K, 4000K, TW  
 CRI ≥ 80, CRI ≥ 90, 3 SDCM  
 UGR ≤ 19 / 65° ≤ 3000 cd/m²  
 up to 3090 lm/m  
 up to 140 lm/W  
 L90 @ 50 000h  
 non DIM, DALI-2  
 opal, microprismatic (UGR ≤ 19)

### Types

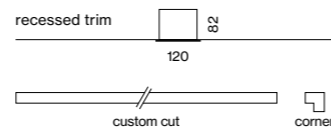

### Colours



### Light distributions



DiiA® standards  
251, 252, 253



single luminaire  
(p.522)



wallwasher  
inset (p.944)

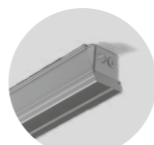

concrete install.  
housing (p.946)



flexible  
inset



DIN EN 12464-1  
UGR ≤ 19

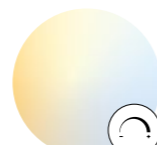

tunable white  
2700–6500K

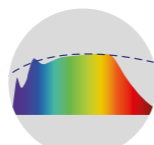

CRI ≥ 98  
XPECTRUM

### Order options

LED TYPE	
mid lumen	L
high lumen	M

COLOUR TEMPERATURE	
3000K (CRI ≥ 90)	0
4000K (CRI ≥ 90)	1
3000K (CRI ≥ 80)	5
4000K (CRI ≥ 80)	6
tunable white 2700–6500K*	

\*DALI-2 DT8

CONTROL	
non DIM	1
DALI-2 (only high lumen)	3

MATERIAL COLOUR	
traffic white RAL 9016	7
white aluminium RAL 9006	G

LIGHT OPTIC COVER	
opal high performance	H
microprismatic	Z
microprismatic (UGR ≤ 19)*	G
blind cover**	B

\*UGR ≤ 19 only with mid lumen  
 \*\*only for channel corner 90°

EMERGENCY LIGHT	
1h Accupack	N L 1
3h Accupack	N L 3

### Options on request

COLOUR RENDERING INDEX	
CRI ≥ 98 XPECTRUM	

CONNECTOR	
X- and T-connector	

LUMINOUS FLUX value calculated for CRI ≥ 80, colour white, cover opal microprism. Z -8%, microprism. G -10%

### FRAME 100 trim

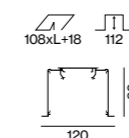

INSTALLATION CHANNEL / CORNER 90°	L (mm)	ORDER CODE
channel	1172	035-0125
channel	1472	035-0155
channel	3000	035-0305
channel	custom	E82150
channel corner 90° + cover	205x205	035-1265

LIGHT OPTIC COVER / BLIND COVER	L (mm)	ORDER CODE
linear	1171	006-12122
linear	1470	006-12152
linear	2997	006-12302
linear	custom	E80650
blind cover	3000	006-1130
blind cover	custom	E80650

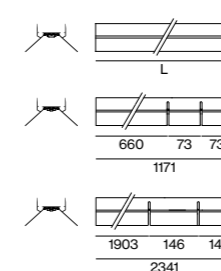

LIGHT INSET 100	SYSTEM POWER (MID/HIGH LUMEN)	L (mm)	ORDER CODE
8.7/13.8W		571	007-862
13/20.6W		871	007-863
15.3/27.5W		1171	007-864
19.2/34W		1463	007-865
31/55W		2341	007-868
38/68W		2997	007-869
15.3/27.5W flex		660-1171	007-86F
31/55W flex		1903-2341	007-86G

COVER	COLOUR TEMP.	SYSTEM POWER	DELIVERED LUMENS	EFFICACY
mid lumen/opal	3000K	14 W/m	1770 lm/m	132 lm/W
high performance	4000K		1870 lm/m	140 lm/W
high lumen/opal	3000K	24 W/m	2920 lm/m	123 lm/W
high performance	4000K		3090 lm/m	130 lm/W

### LIGHT INSET 100 tunable white 2700–6500K

SYSTEM POWER	L (mm)	ORDER CODE
21.7W	871	007-8633D37
29W	1171	007-8634D37
36W	1463	007-8635D37
58W	2341	007-8638D37

### Accessories

END CAPS	ORDER CODE
end caps (pair)	035-1315

LINEAR CONNECTOR / THROUGH WIRE	ORDER CODE
linear connector (1 piece)	005-40066
linear connector (10 pieces)	005-40066.10
opal cover linear connector	006-10000
through wire 3 × 1.5 mm² (non DIM, 10 pieces)	004-90003
through wire 5 × 1.5 mm² (DALI-2, 10 pieces)	004-90005

MOUNTING BRACKET	CEILING THICKNESS (mm)	ORDER CODE
mounting bracket (1 piece)	8-25	035-10230
mounting bracket (25 pieces)	8-25	035-10230.25

number of brackets required: length of your system in metres+1



**CMS Office** Paris, FR –  
by Lobjoy & Bouvier & Boisseau



# Discreet profile system

## CANYON system

**EN** The CANYON system luminaire radiates calm and makes visitors feel welcome – whether in entrance halls, at the reception, or in corridors or lounges. The specially developed, flex insets, which can be shortened, make the luminaire a true all-round talent; with its tailored profile length, the luminaire can also be transformed into a customised lighting system by using CORNER elements. Also noteworthy: When combined with the opal cover, the CANYON system luminaire creates uniform ambient lighting. For workstations, it can be perfectly adapted to office conditions using insets with microprismatic covers.

**IT** Nella variante in sistema, CANYON trasmette armonia mettendo le persone a proprio agio in ogni tipo di ambiente, che si tratti di ingressi, reception, corridoi o sale d'intrattenimento. L'apparecchio è un vero talento universale in virtù dei suoi inserti flessibili che si possono accorciare: una volta scelto il profilo della lunghezza preferita, utilizzando gli elementi CORNER si riesce a comporre un sistema del tutto personalizzato. Un altro pregio: CANYON abbinato ai rifrattori opali diffonde un'illuminazione generale unitaria. Per le postazioni di lavoro negli uffici si creano invece condizioni perfette con gli inserti microprismatizzati.

### Type



60

### Mounting

trim  
recessed

### Configurations



linear



corner

### Light distributions

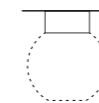

opal

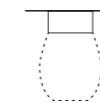
microprismatic  
(UGR ≤ 19)

← back



## CANYON 60 system

recessed offset with trim

EN Luminaire housing made of extruded aluminium; uncluttered ceiling look through recessed lighting level; recessed luminaire with trim; for continuous lighting systems; for ceiling thickness of 8-25mm; surface powder coated; luminaire profile for mounting available in advance; remaining luminaire components mounted without tools; light inset consisting of highly reflective coated extruded profile for improved thermal management; option: lighting module is versatile in length; HPO (High Performance Opal) cover for uniform illumination; micro prismatic PMMA diffuser incl. diffuser film for homogeneous illumination and reduced luminance; wallwasher light inset; energy-efficient LEDs with very good colour rendering

IT Corpo illuminante in profilo di alluminio estruso; superficie di emissione arretrata per un soffitto di aspetto armonioso; apparecchio da incasso con bordo perimetrale; per file continue; per soffitti di spessore 8-25mm; verniciatura a polvere; profilo consegnabile in anticipo; restanti componenti montabili senza utensili; unità d'illuminazione in profilo di alluminio estruso con verniciatura altamente riflettente per gestione termica migliorata; in opzione unità luminosa accorciabile con flessibilità; diffusore HPO (High Performance Opal) per un'illuminazione omogenea; rifrattore in PMMA a microprismi incl. pellicola di diffusione per ridurre la luminanza mantenendo l'illuminazione omogenea; inserto luminoso wallwasher; LED ad efficienza energetica con elevata resa cromatica

### Quickinfo

3000K, 4000K, TW  
CRI ≥ 80, CRI ≥ 90, 3 SDCM  
up to 2280lm/m  
up to 105lm/W  
L90 @ 50 000h  
non DIM, DALI-2  
opal, microprismatic

### Types

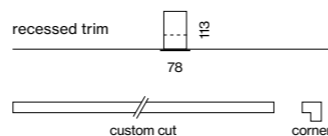

### Colours



### Light distributions



### Order options

LED TYPE	
mid lumen	L
high lumen	M

COLOUR TEMPERATURE	
3000K (CRI ≥ 90)	0
4000K (CRI ≥ 90)	1
3000K (CRI ≥ 80)	5
4000K (CRI ≥ 80)	6
tunable white 2700-6500K*	

\*DALI-2 DT8

CONTROL	
non DIM	1
DALI-2 (only high lumen)	3

MATERIAL COLOUR	
○ traffic white RAL 9016	7
● jet black RAL 9005	8

LIGHT OPTIC COVER	
opal high performance	H
microprismatic	Z
blind cover*	B

\*only for channel corner 90°

EMERGENCY LIGHT	
1h Accupack	N L 1
3h Accupack	N L 3

### Options on request

COLOUR RENDERING INDEX	
CRI ≥ 98 XPECTRUM	

CONNECTOR	
X- and T-connector	



DiiA® standards  
251, 252, 253



single luminaire  
(p.528)



wallwasher  
inset (p.944)



ball-impact-  
resistant



glare control  
UGR ≤ 19

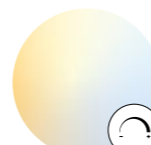

tunable white  
2700-6500K

LUMINOUS FLUX value calculated for CRI ≥ 80, colour white, cover opal microprismatic -13%

### CANYON 60 trim offset

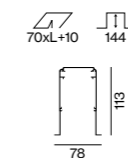

INSTALLATION CHANNEL / CORNER 90°	L (mm)	ORDER CODE
channel	1172	038-5127
channel	1472	038-5157
channel	3000	038-5307
channel	custom	E82330
channel corner 90° + cover	144x144	038-6267

### LIGHT OPTIC COVER / BLIND COVER

LIGHT OPTIC COVER / BLIND COVER	L (mm)	ORDER CODE
linear	1171	006-16122
linear	1470	006-16152
linear	2997	006-16302
linear	custom	E80630
blind cover	1472	006-1815
blind cover	custom	E80630



### LIGHT INSET 60

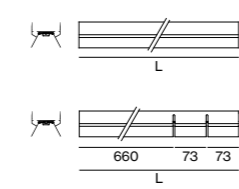

SYSTEM POWER (MID / HIGH LUMEN)	L (mm)	ORDER CODE
8.7 / 13.8 W	571	007-932
13 / 20.6 W	871	007-933
15.3 / 27.5 W	1171	007-934
19.2 / 34 W	1463	007-935
31 / 55 W	2341	007-938
38 / 68 W	2997	007-939
15.3 / 27.5 W flex	660-1171	007-93F
31 / 55 W flex	1903-2341	007-93G

COVER	COLOUR TEMP.	SYSTEM POWER	DELIVERED LUMENS	EFFICACY
mid lumen / opal	3000K	14 W/m	1300lm/m	99lm/W
high performance	4000K		1380lm/m	105lm/W
high lumen / opal	3000K	24 W/m	2160lm/m	92lm/W
high performance	4000K		2280lm/m	98lm/W

### LIGHT INSET 60 tunable white 2700-6500K

SYSTEM POWER	L (mm)	ORDER CODE
21.7 W	871	007-9333D37
29 W	1171	007-9334D37
36 W	1463	007-9335D37
58 W	2341	007-9338D37

### Accessories

#### END CAPS

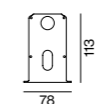

TYPE	ORDER CODE
end caps (pair)	038-6307

#### LINEAR CONNECTOR / THROUGH WIRE

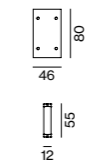

TYPE	ORDER CODE
linear connector (1 piece)	005-40046
linear connector (10 pieces)	005-40046.10
opal cover linear connector	006-14000
through wire 3 × 1.5 mm² (non DIM, 10 pieces)	004-90003
through wire 5 × 1.5 mm² (DALI-2, 10 pieces)	004-90005

#### MOUNTING BRACKET

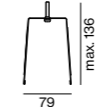

TYPE	CEILING THICKNESS (mm)	ORDER CODE
mounting bracket (1 piece)	8-25	038-60700
mounting bracket (25 pieces)	8-25	038-60700.25

number of brackets required: length of your system in metres+1



**Microsoft headquarters**  
Vienna, AT – by INNOCAD Architektur ZT



# Define your profile system

## MINO system

**EN** The MINO system luminaire complements the multifaceted nature of the MINO single luminaire. Whether as a surface-mounted version for wall or ceiling mounting, or as a suspended version with an indirect light component, the MINO System luminaire is truly versatile. Using CURVE elements, which come in various radii, and CORNER elements, the luminaires are transformed into a continuous lighting system. With three standard and additional special colours available, MINO can be customised according to the desired room concept. You can also combine the light insets for homogeneous ambient lighting with an opal cover. Other options include the use of a wallwasher for a uniformly illuminated wall surface, or the microprismatic cover specially designed for workstations. Excellent colour rendering and three possible light colours complete the MINO system luminaire.

**IT** L'apparecchio MINO da montare in sistema completa la versatile gamma di MINO singolo. La scelta comprende varianti da installare a plafone su pareti e soffitti oppure modelli a sospensione con componente di luce indiretta: MINO è un sistema utilizzabile con flessibilità. Con gli elementi CORNER e CURVE, disponibili in vari raggi, i singoli apparecchi si uniscono in una composizione ininterrotta. Per adattarsi al contesto specifico sono previsti tre colori standard e altri colori speciali in opzione. Si possono scegliere diversi inserti luminosi, anche alternandoli: rifrattore opale per una luminosità generale omogenea, wallwasher per illuminare le pareti con uniformità oppure rifrattore a microprismi concepito appositamente per l'illuminazione dei posti di lavoro. Tra i pregi di MINO in sistema figurano anche l'ottima resa cromatica e tre possibili tonalità di luce.

### Types

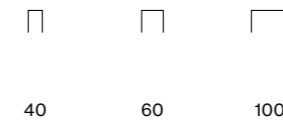

40      60      100

### Mountings

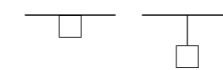

surface      suspended

### Configurations

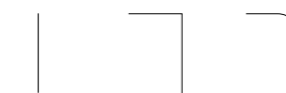

linear      corner      curve

### Light distributions

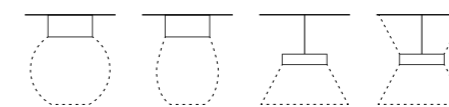

opal      microprismatic  
(UGR ≤ 19)      direct      direct  
indirect

## TW – Tunable White

EN Changes in the colour of light have a substantial effect on our mood. Tunable White allows the colour temperature to be continuously adjusted from 2700 K (warm light) to 6500 K (cool light) to dynamically adapt the lighting to the time of day or ambient brightness.

IT I cambiamenti del colore di luce hanno un effetto importante sul nostro stato d'animo. Tunable White consente di variare la temperatura di colore in regolazione continua da 2700K (luce calda) a 6500K (luce fredda), adattando dinamicamente l'illuminazione artificiale all'ora del giorno o alla luminosità circostante.

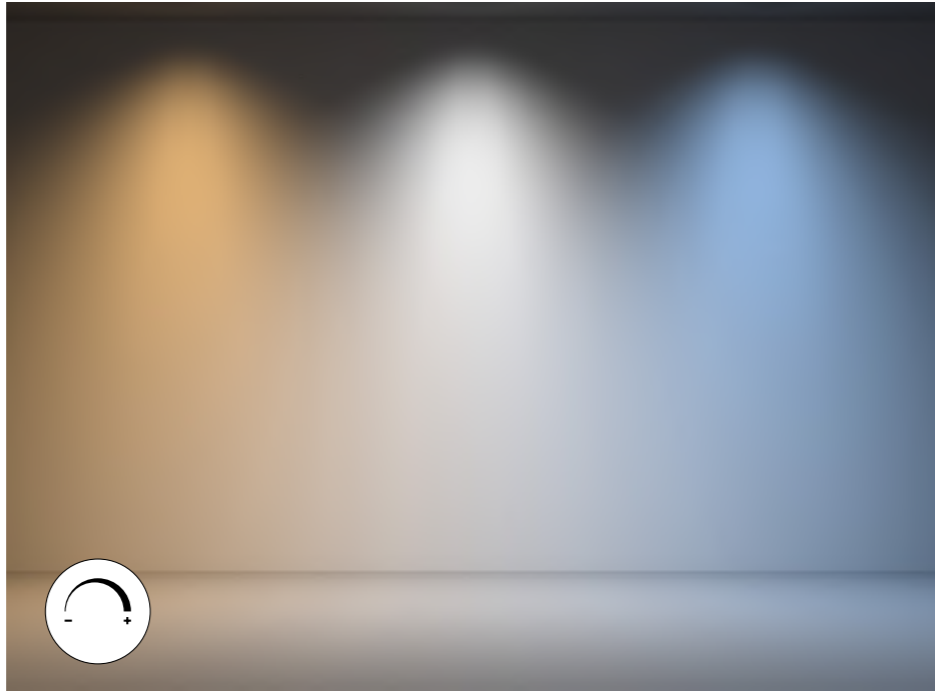

## Precise planning with flex insets

EN Your lighting system can be easily adapted to existing room dimensions. You can determine bespoke lengths for MINO. The special flex insets are precisely and flexibly adapted on-site during assembly. Boards are simply cut off at prefabricated breakpoints. This gives you a free hand and minimal restrictions in the lighting design.

IT Il sistema d'illuminazione si adatta con flessibilità alle dimensioni di un ambiente. Per i profili Advanced si possono decidere le lunghezze individualmente. Gli inserti luminosi sono speciali moduli Flex che al momento del montaggio si adattano con flessibilità e precisione: i chip vengono semplicemente tagliati in corrispondenza delle tacche già predisposte escludendo così qualsiasi tipo di limitazione al progetto illuminotecnico.

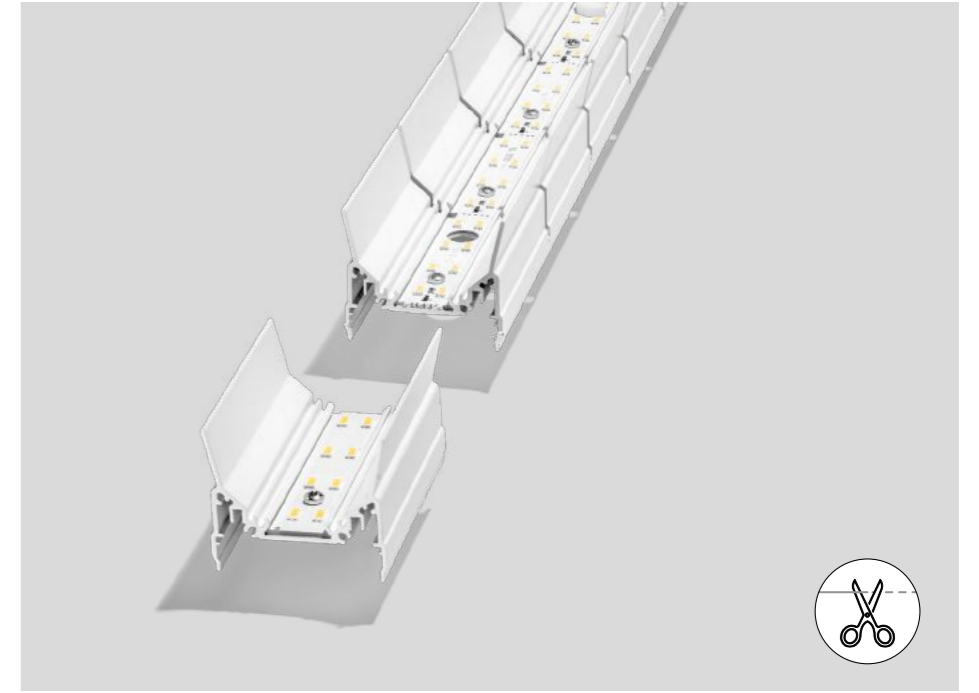

## Full-spectrum LED

EN XAL's new XPECTRUM LEDs deliver healthy, biologically effective light. The reduced blue light component and increased cyan values reduce the blue light hazard for the eye to daylight-equivalent levels. The resulting non-visual, so-called melanopic light effect, improves concentration and increases sleep quality. The excellent colour rendering of IES TM 30-15  $R_i = 98$  and  $R_g = 101$  further helps visual comfort.

IT Il nuovo XPECTRUM LED di XAL assicura una luce sana con efficacia biologica. Lo spettro riduce le componenti azzurre e aumenta invece il ciano, con il risultato di una luce simile a quella diurna in cui i rischi per gli occhi dell'azzurro sono contenuti al minimo. Ne consegue un effetto non visivo, chiamato anche melanopico, che favorisce la concentrazione e migliora la qualità del sonno. Inoltre l'eccellente resa cromatica IES TM 30-15  $R_i = 98$  e  $R_g = 101$  migliora il comfort visivo.

XPECTRUM LED

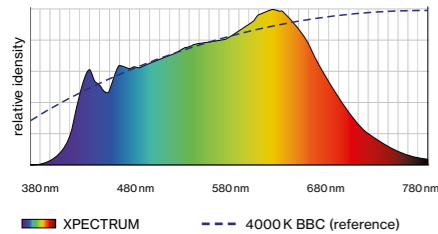

Commercially available LED 4000 K

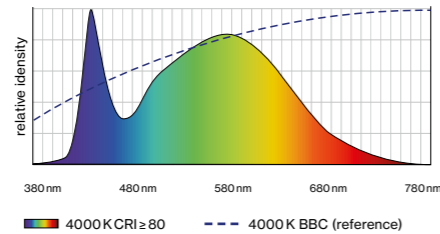

## Colour variety

EN MINO is available in the standard colours black, grey, and white. Further colour variations are also available, granting your project maximum design freedom. You can learn more about our colour palette at [xal.com/colours](http://xal.com/colours).

IT Tutti i profili Advanced sono disponibili in vari colori standard. Oltre a questi, si possono scegliere anche altri colori speciali in modo da personalizzare il progetto. Per conoscere la gamma di colori consultare [xal.com/colours](http://xal.com/colours).



[xal.com/colours](http://xal.com/colours)

## Curves & edges

EN Let your creativity run wild and combine straight profiles with precise corners or harmonious curves. The curve profiles are available in different radii to generate maximum design freedom.

IT Date libero sfogo alla vostra creatività combinando profili lineari con giunti angolari o armoniose curve. I profili curvi sono disponibili con diversi raggi che assicurano la massima libertà compositiva. Tutti gli elementi sono reciprocamente compatibili, pertanto potete configurare il sistema nel modo preferito e secondo lo spazio disponibile.



← back

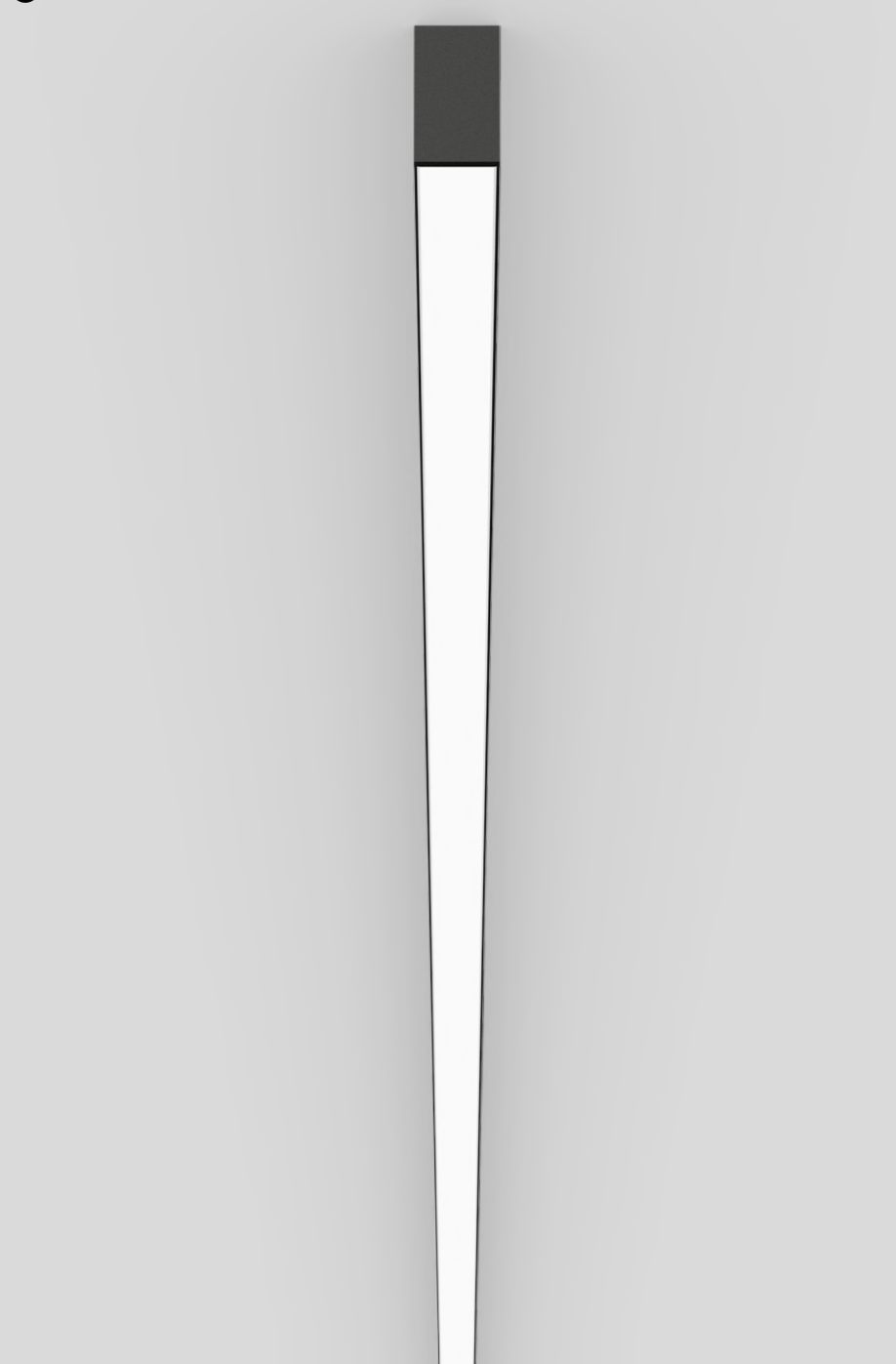

# MINO 40 system

ceiling/suspended

EN Luminaire housing from extruded aluminium profile, angular design; no visible screws; for lighting systems; powder coated; luminaire profile incl. light inset; cover in the length of the light inset or continuous cover (both separately available); pre-assembled power rail for power supply in luminaire profile; voltage tap of the light inset on the power rail; pendant fitting with cable suspension; height adjustment without tools; with transparent feeder cable; light inset consisting of highly reflective coated extruded profile for improved thermal management; HPO (High Performance Opal) cover for uniform illumination; energy-eff. LEDs – very good colour rendering

IT Corpo illuminante in profilo di alluminio estruso, modello squadrato; nessuna vite visibile; per sistemi di illuminazione; verniciatura a polvere; profilo con inserto luminoso; cover della lunghezza dell'inserto luminoso o continua (entrambe da ordinare separ.); binario elettrificato premontato per l'alimentazione nel profilo; presa di tens. per inserto lum. sul binario elettr.; sospeso con cavo a sospensione; regolazione altezza senza utensili; con cavo di alimentazione trasparente; unità d'illuminazione in profilo di alluminio estruso con verniciatura altamente riflettente per gestione termica migliorata; diffusore HPO (High Performance Opal) per un'illuminazione omogenea; LED a risp. energ. – ottima resa cromatica

## Quickinfo

3000K, 4000K  
 CRI ≥ 90, 3 SDCM  
 up to 2340lm/m  
 up to 102lm/W  
 L90 @ 50 000h  
 DALI-2  
 opal

## Types

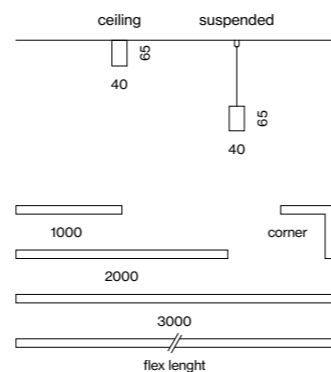

## Colours



## Light distribution



DiiA® standards  
 251, 252, 253



single luminaire  
 (p. 536)

flexible  
 inset

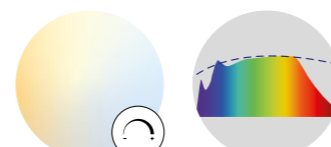

tunable white  
 2700–6500K

CRI ≥ 98  
 XPECTRUM

## Order options

LED TYPE	
mid lumen	1
high lumen	2

COLOUR TEMPERATURE	
3000K	0
4000K	1

CONTROL  
 DALI-2

MATERIAL COLOUR	
○ pure white RAL 9010	7
● white aluminium RAL 9006	G
● jet black RAL 9005	8
● special colours p. 992	X

MATERIAL COLOUR	
○ pure white RAL 9010	7
● jet black RAL 9005	8

LIGHT OPTIC COVER  
 opal high performance

## Options on request

COLOUR RENDERING INDEX  
 CRI ≥ 98 XPECTRUM

COLOUR TEMPERATURE  
 tunable white 2700–6500K

LIGHT OPTIC COVER  
 microprismatic

## MINO 40 ceiling/suspended

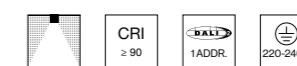

### INSTALLATION CHANNEL + LIGHT INSET

SYSTEM POWER (MID/HIGH LUMEN)	L (mm)	ORDER CODE
15.3/22.9W	1000	0 4 2 - 1 0 A 2 3 3
30.5/46W	2000	0 4 2 - 1 0 A 4 3 3
46/69W	3000	0 4 2 - 1 0 A 6 3 3
15.3/22.9W flex	500–1000	0 4 2 - 1 0 A F 3 3
30.5/46W flex	1500–2000	0 4 2 - 1 0 A G 3 3
15.3/22.9W corner	500×500	0 4 2 - 1 0 A C 3 3

COVER	COLOUR TEMP.	SYSTEM POWER	DELIVERED LUMENS	EFFICACY
mid lumen/opal	3000K	15.3 W/m	1480lm/m	97lm/W
high performance	4000K		1560lm/m	102lm/W
high lumen/opal	3000K	22.9 W/m	2210lm/m	97lm/W
high performance	4000K		2340lm/m	102lm/W

### LIGHT OPTIC COVER 40

TYPE	L (mm)	ORDER CODE
linear	1000	0 0 6 - 4 2 1 0 0 1 0 H
linear	2000	0 0 6 - 4 2 2 0 0 1 0 H
linear	3000	0 0 6 - 4 2 3 0 0 1 0 H
corner	500×500	0 0 6 - 4 2 0 5 0 2 0 H
continuous linear	6000	0 0 6 - 2 2 0 6 0 1 0 H
continuous linear	30000	0 0 6 - 2 2 3 0 0 1 0 H

## Accessories



END CAPS	ORDER CODE
TYPE end caps (pair)	0 4 2 - 1 0 9 0 0 1



CHANNEL + BLIND COVER	L (mm)	ORDER CODE
TYPE linear	1000	0 4 2 - 1 0 9 4 2 1
linear	2000	0 4 2 - 1 0 9 4 4 1
linear	3000	0 4 2 - 1 0 9 4 6 1
corner	500×500	0 4 2 - 1 0 9 4 C 1



POWER FEEDER UNIT	ORDER CODE
TYPE power feeder unit	0 4 2 - 1 0 9 3 2 3 0



LINEAR CONNECTOR	ORDER CODE
TYPE mechanical linear connector	0 4 2 - 1 0 9 1 1 1 0
mechanical + electrical linear connector	0 4 2 - 1 0 9 1 2 3 0
opal cover linear connector	0 4 2 - 1 0 9 1 9 1 0

### CEILING FASTENER/CABLE SUSPENSION/CANOPY

TYPE	L (mm)	ORDER CODE
ceiling fastener	10	0 5 0 - 2 0 4 1 1 1
cable suspension	1500	0 0 5 - 2 1 5 2 1 1 0
canopy		0 0 5 - 2 3 1 1 2 1
feeder cable (transparent)		0 0 5 - 2 4 1 2 4 1 0

for electrical system configuration see luminaire data sheet at xal.com

LUMINOUS FLUX value calculated for  
 CRI ≥ 90, colour white, cover opal



← back

# MINO 60 system

ceiling / suspended

EN Luminaire housing from extruded aluminium profile, angular design; no visible screws; for lighting systems; powder coated; luminaire profile for mounting available in advance; remaining components mounted without tools; pendant fitting with cable suspension; height adjustment without tools; spring clip attachment to the luminaire; with transparent feeder cable; light inset consisting of highly reflective coated extruded profile for improved thermal management; option: lighting module is versatile in length; HPO (High Performance Opal) cover for uniform illumination; micro prismatic PMMA diffuser incl. diffuser film for homogeneous illumination and reduced luminance; wallwasher light inset; energy-eff. LEDs – very good colour rendering

IT Corpo illuminante in profilo di alluminio estruso, modello squadrato; nessuna vite visibile; per sistemi di illuminazione; verniciatura a polvere; profilo consegnabile in anticipo; tutti gli altri componenti si fissano senza bisogno di utensili; sospeso con cavo a sospensione; regolazione altezza senza utensili; fissaggio con graffe sul corpo illuminante; con cavo di alimentazione trasparente; unità d'illuminazione in profilo di alluminio estruso con verniciatura altamente riflettente per gestione termica migliorata; in opzione unità luminosa accorciabile con flessibilità; diffusore HPO (High Performance Opal) per un'illuminazione omogenea; rifrattore in PMMA a microprismi incl. pellicola di diffusione per ridurre la luminanza mantenendo l'illuminazione omogenea; inserto luminoso wallwasher; LED a risp. energ. – ottima resa cromatica

## Quickinfo

3000K, 4000K, TW  
 CRI ≥ 80, CRI ≥ 90, 3 SDCM  
 up to 2760 lm/m  
 up to 125 lm/W  
 L90 @ 50 000h  
 non DIM, DALI-2  
 opal, microprismatic (UGR ≤ 19)

## Types

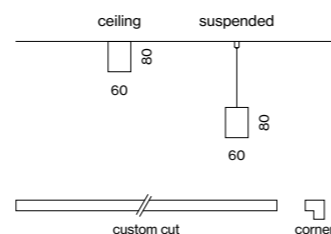

## Colours



## Light distributions



DiiA® standards 251, 252, 253



single luminaire (p.544)



wallwasher inset (p.944)

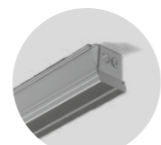

concrete install. housing (p.946)



flexible inset

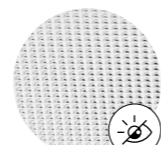

microprismatic UGR ≤ 19

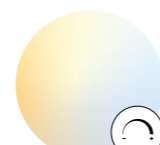

tunable white 2700–6500K

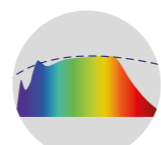

CRI ≥ 98 XPECTRUM

## Order options

LED TYPE	
mid lumen	L
high lumen	M

COLOUR TEMPERATURE	
3000K (CRI ≥ 90)	0
4000K (CRI ≥ 90)	1
3000K (CRI ≥ 80)	5
4000K (CRI ≥ 80)	6
tunable white 2700–6500K*	

\*DALI-2 DT8

CONTROL	
non DIM	1
DALI-2 (only high lumen)	3

MATERIAL COLOUR	
○ pure white RAL 9010	7
● white aluminium RAL 9006	G
● jet black RAL 9005	8
● special colours p.992	X

LIGHT OPTIC COVER	
opal high performance	H
microprismatic	Z
microprismatic (UGR ≤ 19)*	G
blind cover only for corner 90°	B

\*UGR ≤ 19 only with mid lumen

EMERGENCY LIGHT	
1h Accupack	1
3h Accupack	3

## Options on request

COLOUR RENDERING INDEX	
CRI ≥ 98 XPECTRUM	

CONNECTORS	
X- and T-connector	

LUMINOUS FLUX value calculated for CRI ≥ 80, colour white, cover opal microprismatic -13%

## MINO 60 ceiling / suspended



INSTALLATION CHANNEL / CORNER 90°			ORDER CODE
TYPE	L (mm)		
channel	1172		046-400401
channel	1472		046-400501
channel	3000		046-400901
channel	custom		E85031
channel corner 90° + cover	150x150		046-401121

LIGHT OPTIC COVER / BLIND COVER			ORDER CODE
TYPE	L (mm)		
linear	1171		006-16122
linear	1470		006-16152
linear	2997		006-16302
linear	custom		E80630
continuous linear	6000		006-23061H
continuous linear	25000		006-23251H
blind cover	3000		006-1830
blind cover	custom		E80630

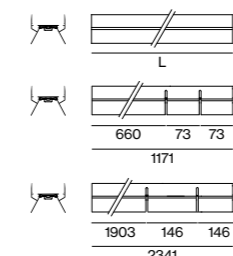

LIGHT INSET 60			ORDER CODE
SYSTEM POWER (MID / HIGH LUMEN)	L (mm)		
8.7 / 13.8 W	571		007-932
13 / 20.6 W	871		007-933
15.3 / 27.5 W	1171		007-934
19.2 / 34 W	1463		007-935
31 / 55 W	2341		007-938
38 / 68 W	2997		007-939
15.3 / 27.5 W flex	660-1171		007-93F
31 / 55 W flex	1903-2341		007-93G

COVER	COLOUR TEMP.	SYSTEM POWER	DELIVERED LUMENS	EFFICACY
mid lumen / opal	3000K	14 W/m	1540 lm/m	118 lm/W
high performance	4000K		1640 lm/m	125 lm/W
high lumen / opal	3000K	24 W/m	2540 lm/m	110 lm/W
high performance	4000K		2700 lm/m	116 lm/W

LIGHT INSET 60 tunable white 2700–6500K			ORDER CODE
SYSTEM POWER	L (mm)		
21.7 W	871		007-9333D37
29 W	1171		007-9334D37
36 W	1463		007-9335D37
58 W	2341		007-9338D37

## Accessories



END CAPS		ORDER CODE
TYPE		
end caps (pair)		046-501001



LINEAR CONNECTOR / THROUGH WIRE		ORDER CODE
TYPE		
linear connector (1 piece)		005-40046
linear connector (10 pieces)		005-40046.10
opal cover linear connector		006-14000
through wire 3 × 1.5 mm <sup>2</sup> (non DIM, 10 pieces)		004-90003
through wire 5 × 1.5 mm <sup>2</sup> (DALI-2, 10 pieces)		004-90005

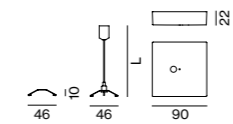

CEILING CLIP / CABLE SUSPENSION / CANOPY			ORDER CODE
TYPE	L (mm)		
ceiling clip	10		034-11636
cable suspension	1500		005-2122110
canopy / feeder cable 3 × 1.5 mm <sup>2</sup>	1500		005-221231
canopy / feeder cable 5 × 1.5 mm <sup>2</sup>	1500		005-221241
cable rail	1200		005-2491110

for electrical system configuration see luminaire data sheet at xal.com

← back

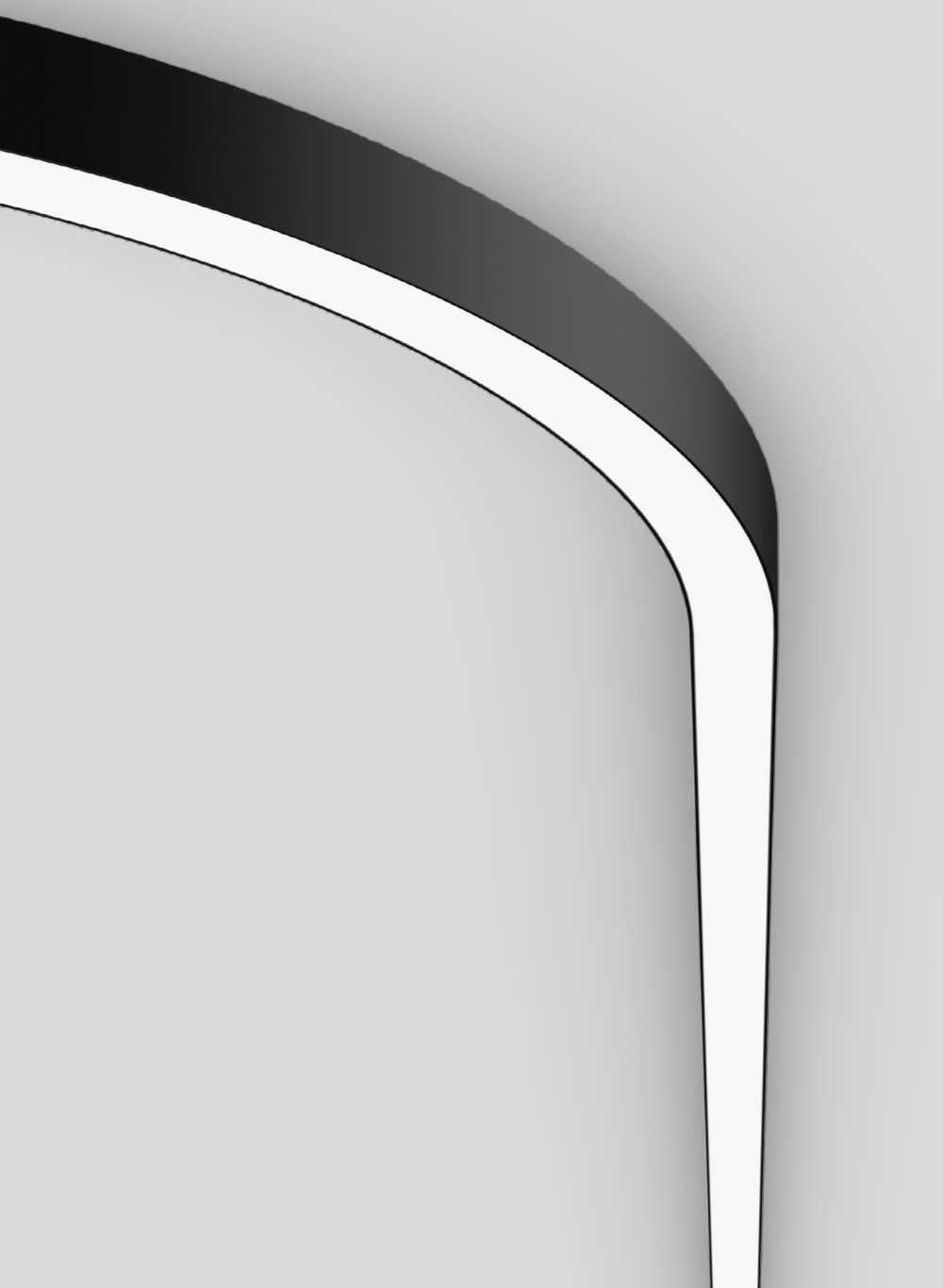

## MINO 60 CURVE system

ceiling / suspended

EN Circular segment of rolled aluminium profile, angular design, seamlessly welded; no visible screws; for lighting systems; powder coated; luminaire profile for mounting available in advance; remaining components mounted without tools; pendant fitting with cable suspension; height adjustment without tools; spring clip attachment to the luminaire; freely positionable; with transparent feeder cable; light inset consisting of highly reflective coated die-cast aluminium for improved thermal management; HPO (High Performance Opal) cover for uniform illumination; micro prismatic PMMA diffuser incl. diffuser film for homogeneous illumination and reduced luminance; energy-eff. LEDs – very good colour rendering

IT Segmento di cerchio in profilo di alluminio rullato in esecuzione squadrata, senza punti di saldatura; nessuna vite visibile; per sistemi di illuminazione; verniciatura a polvere; profilo consegnabile in anticipo; tutti gli altri componenti si fissano senza bisogno di utensili; sospeso con cavo a sospensione; regolazione altezza senza utensili; fissaggio con graffe sul corpo illuminante; libertà di posizionamento; con cavo di alimentazione trasparente; unità d'illuminazione in alluminio pressofuso con verniciatura altamente riflettente per gestione termica migliorata; diffusore HPO (High Performance Opal) per un'illuminazione omogenea; rifrattore in PMMA a microprismi incl. pellicola di diffusione per ridurre la luminanza mantenendo l'illuminazione omogenea; LED a risp. energ. – ottima resa

### Quickinfo

3000K, 4000K  
 CRI ≥ 80, 3 SDCM  
 up to 2850 lm/m  
 up to 125 lm/W  
 L90 @ 50 000h  
 non DIM, DALI-2  
 opal, microprismatic

### Types

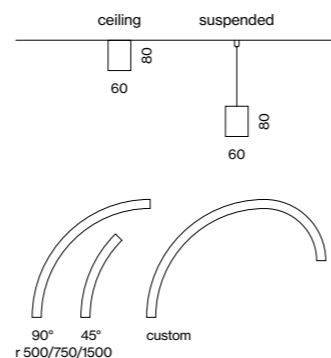

### Colours



### Light distributions



### Order options

LED TYPE	
mid lumen	4
high lumen	5

COLOUR TEMPERATURE	
3000K	5
4000K	6

CONTROL	
non DIM	1
DALI-2 (only high lumen)	3

MATERIAL COLOUR	
○ pure white RAL 9010	7
● white aluminium RAL 9006	G
● jet black RAL 9005	8
● special colours p. 992	X

LIGHT OPTIC COVER	
opal high performance	H
microprismatic	Z

### Options on request

COLOUR RENDERING INDEX	
CRI ≥ 90	
CRI ≥ 98 XPECTRUM	

LIGHT OPTIC COVER	
microprismatic (UGR ≤ 19)	

### MINO 60 CURVE ceiling / suspended

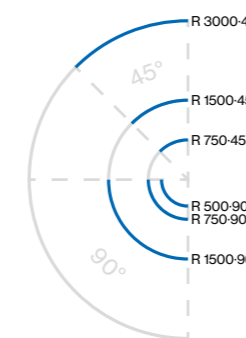

SYSTEM POWER (MID/HIGH LUMEN)	R (mm)	ORDER CODE
12.8 / 16.3 W	500-90°	034-09 5 :: ▣ ▣
10.2 / 12.8 W	750-45°	034-09 0 :: ▣ ▣
18.1 / 26.1 W	750-90°	034-09 1 :: ▣ ▣
18.1 / 26.1 W	1500-45°	034-09 2 :: ▣ ▣
36 / 52 W (2×DALI)	1500-90°	034-09 3 :: ▣ ▣
36 / 52 W (2×DALI)	3000-45°	034-09 4 :: ▣ ▣

COVER	COLOUR TEMP.	SYSTEM POWER	DELIVERED LUMENS	EFFICACY
mid lumen / opal	3000 K	16 W/m	1780 lm/m	116 lm/W
high performance	4000 K		1880 lm/m	122 lm/W
high lumen / opal	3000 K	22 W/m	2420 lm/m	110 lm/W
high performance	4000 K		2560 lm/m	116 lm/W

### Accessories

END CAPS	ORDER CODE
TYPE	
end caps (pair)	034-090201 ▣

LINEAR CONNECTOR	ORDER CODE
TYPE	
linear to curve profile	005-40159
curve to curve profile	005-40158
opal cover linear connector	006-14000

CEILING CLIP / CABLE SUSPENSION / CANOPY	L (mm)	ORDER CODE
TYPE		
ceiling clip	10	034-11636
cable suspension	1500	005-2122110
canopy / feeder cable 3 × 1.5 mm <sup>2</sup>	1500	005-221231 ▣
canopy / feeder cable 5 × 1.5 mm <sup>2</sup>	1500	005-221241 ▣
cable rail	1200	005-2491110

for electrical system configuration see luminaire data sheet at xal.com

THROUGH WIRE	ORDER CODE
TYPE	
3 × 1.5 mm <sup>2</sup> (non DIM, 10 pieces)	004-90003
5 × 1.5 mm <sup>2</sup> (DALI-2, 10 pieces)	004-90005



DiiA® standards  
251, 252, 253

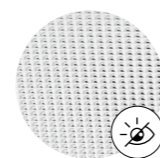

microprismatic  
UGR ≤ 19

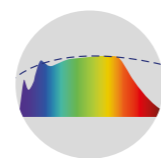

CRI ≥ 98  
XPECTRUM

LUMINOUS FLUX value calculated for CRI ≥ 80, colour white, cover opal microprismatic -13%

← back



## MINO 60 direct/indirect system

ceiling / suspended

EN Luminaire housing from extruded aluminium profile, angular design; direct/indirect light distribution; no visible screws; designed for continuous lighting systems; surface powder coated; pendant fitting with cable suspension; with integrated tool-less suspension height adjustment; spring clip attachment to the luminaire; freely positionable; incl. transparent feed; light inset consisting of highly reflective coated extruded profile for improved thermal management; HPO (High Performance Opal) cover for uniform illumination; micro prismatic PMMA diffuser incl. diffuser film for homogeneous illumination and reduced luminance; energy-efficient LEDs with very good colour rendering

IT Corpo illuminante in profilo di alluminio estruso, modello squadrato; emissione diretta/indiretta; nessuna vite visibile; per sistemi di file continue; verniciatura a polvere; sospeso con cavo a sospensione; altezza regolabile sull'apparecchio, senza utensili; fissaggio sull'apparecchio tramite clip a molla; libertà di posizionamento; incl. cavo di alimentazione trasparente; unità d'illuminazione in profilo di alluminio estruso con verniciatura altamente riflettente per gestione termica migliorata; diffusore HPO (High Performance Opal) per un'illuminazione omogenea; rifrattore in PMMA a microprismi incl. pellicola di diffusione per ridurre la luminanza mantenendo l'illuminazione omogenea; LED ad efficienza energetica con elevata resa cromatica

### Quickinfo

3000K, 4000K  
 CRI ≥ 80, 3 SDCM  
 up to ↓ 2470 / ↑ 1610 lm/m  
 up to 120 lm/W  
 L90 @ 50 000h  
 non DIM, DALI-2  
 opal, microprismatic (UGR ≤ 19)

### Types

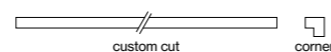
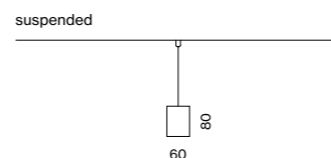

### Colours



### Light distributions



### Order options

**LED TYPE**

mid lumen 1  
 high lumen 2

**COLOUR TEMPERATURE**

3000K 5  
 4000K 6

**CONTROL**

non DIM 1  
 DALI-2 (only high lumen) 3

**MATERIAL COLOUR**

○ pure white RAL 9010 7  
 ● white aluminium RAL 9006 G  
 ● jet black RAL 9005 8  
 ● special colours p. 992 X

**LIGHT OPTIC COVER**

opal high performance H  
 microprismatic (UGR ≤ 19) Z

### Options on request

**COLOUR RENDERING INDEX**

CRI ≥ 90  
 CRI ≥ 98 XPECTRUM

**CHANNEL LENGTH**

3000mm

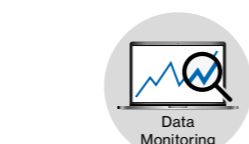

DiiA® standards  
 251, 252, 253

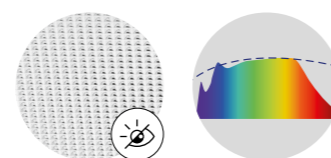

microprismatic UGR ≤ 19  
 CRI ≥ 98 XPECTRUM

### Light distributions

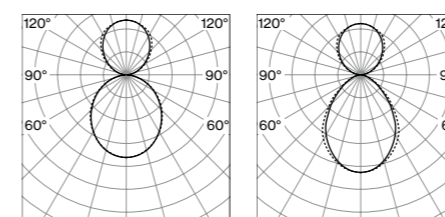

opal direct/indirect  
 microprismatic direct/indirect

**LUMINOUS FLUX** value calculated for  
 CRI ≥ 80, colour white, cover opal  
 microprismatic -13%

### MINO 60 direct/indirect suspended



#### INSTALLATION CHANNEL + LIGHT INSET + LIGHT OPTIC COVER

SYSTEM POWER (MID/HIGH LUMEN)	L (mm)	ORDER CODE
20.1W/31W	872	046-503
26.8W/41W	1172	046-504
34W/51W	1464	046-505
40W/62W	1756	046-506
54W/82W	2344	046-508
26.8W corner / mid lumen	625x625	046-5051
42W corner / high lumen	625x625	046-5061

COVER	COLOUR TEMP.	SYSTEM POWER	DIRECT LUMENS	INDIRECT LUMENS	EFFICACY
mid lumen/	3000K	22W/m	1490lm/m	950lm/m	113lm/W
opal high p.	4000K		1440lm/m	1010lm/m	120lm/W
high lumen/	3000K	35W/m	2330lm/m	1520lm/m	108lm/W
opal high p.	4000K		2470lm/m	1610lm/m	115lm/W

#### BLIND CHANNEL / BLIND COVER

blind channel	custom	E 85031
blind cover	custom	E 80630

### Accessories



END CAPS	ORDER CODE
TYPE	
end caps (pair)	046-501001



LINEAR CONNECTOR	ORDER CODE
TYPE	
linear connector (1 piece)	005-40046
linear connector (10 pieces)	005-40046.10
opal cover linear connector	006-14000

#### CABLE SUSPENSION / CANOPY

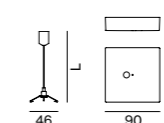

CABLE SUSPENSION / CANOPY	L (mm)	ORDER CODE
TYPE		
cable suspension	1500	005-2122110
canopy / feeder cable 3 × 1.5 mm <sup>2</sup>	1500	005-221231
canopy / feeder cable 5 × 1.5 mm <sup>2</sup>	1500	005-221241
cable rail	1200	005-2491110

for electrical system configuration see luminaire data sheet at xal.com

#### THROUGH WIRE

THROUGH WIRE	ORDER CODE
TYPE	
3 × 1.5 mm <sup>2</sup> (non DIM, 10 pieces)	004-90003
5 × 1.5 mm <sup>2</sup> (DALI-2, 10 pieces)	004-90005



**Feucht Mode** Innsbruck, AT –  
by blocher partners with lighting design  
by Hallight Lichtplanung, Andreas Haidegger

Airport Singapore T4 Terminal  
Singapore, SG – by Snohetta

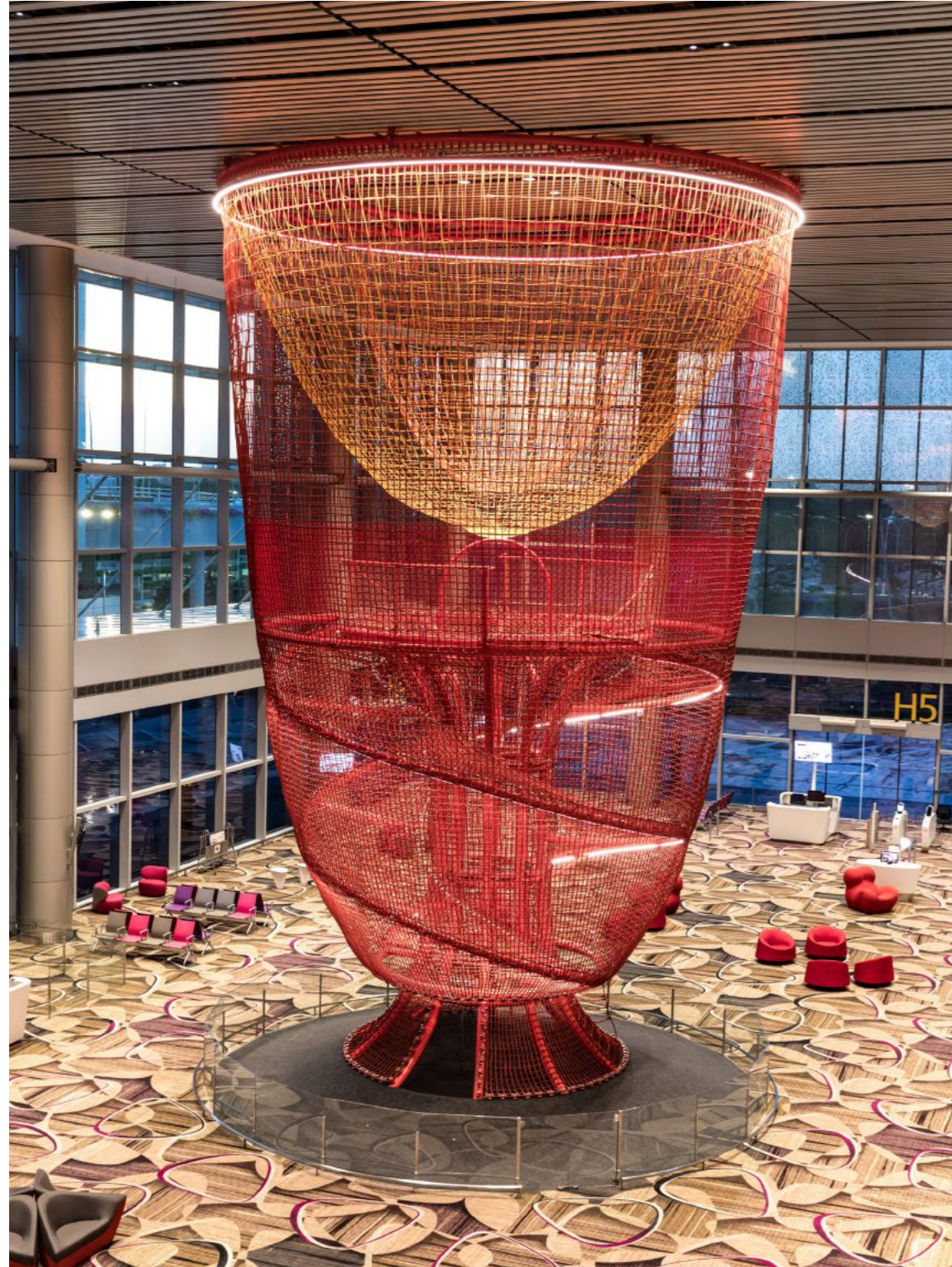



Novo Nordisk Zurich, CH

**WKO** Vienna, AT –  
by Architekturconsult with lighting  
design by Hailight Lichtplanung,  
Andreas Haidegger



← back

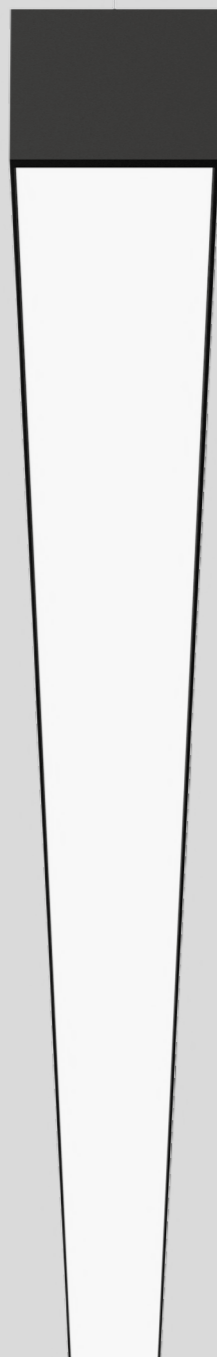

## MINO 100 system

ceiling / suspended

EN Luminaire housing from extruded aluminium profile, angular design; no visible screws; for lighting systems; powder coated; luminaire profile for mounting available in advance; remaining components mounted without tools; pendant fitting with cable suspension; height adjustment without tools; spring clip attachment to the luminaire; with transparent feeder cable; light inset consisting of highly reflective coated extruded profile for improved thermal management; option: lighting module is versatile in length; HPO (High Performance Opal) cover for uniform illumination; micro prismatic PMMA diffuser incl. diffuser film for homogeneous illumination and reduced luminance; wallwasher light inset; energy-eff. LEDs – very good colour rendering

IT Corpo in profilo di alluminio estruso, modello squadrato; nessuna vite visibile; per sistemi di illum.; verniciatura a polvere; profilo consegnabile in anticipo; tutti gli altri componenti si fissano senza bisogno di utensili; sospeso con cavo a sosp.; regolazione altezza senza utensili; fissaggio con graffe sul corpo; cavo trasparente; unità d'illum. in profilo di alluminio estruso, verniciatura riflettente per gestione termica migliorata; in opzione unità luminosa accorciabile; diffusore HPO per un'illuminazione omogenea; rifrattore in PMMA a microprismi incl. pellicola di diffusione per ridurre la luminanza mantenendo l'illuminazione omogenea; inserto luminoso wallwasher; LED a risparmio energ. – ottima resa cromatica

### Quickinfo

3000K, 4000K, TW  
 CRI ≥ 80, CRI ≥ 90, 3 SDCM  
 UGR ≤ 19 / 65° ≤ 3000 cd/m²  
 up to 3090 lm/m  
 up to 140 lm/W  
 L90 @ 50 000h  
 non DIM, DALI-2  
 opal, microprismatic (UGR ≤ 19)

### Types

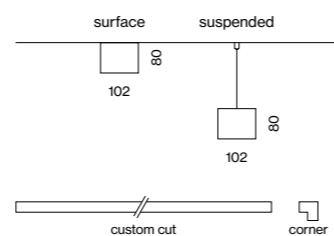

### Colours



### Light distributions



DiiA® standards  
251, 252, 253



single luminaire  
(p.552)



wallwasher  
inset (p.944)



DIN EN 12464-1  
UGR ≤ 19



flexible  
inset

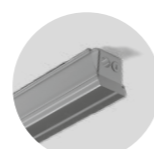

concrete install.  
housing (p.946)

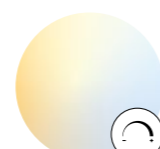

tunable white  
2700–6500K

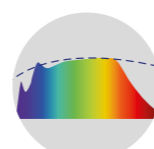

CRI ≥ 98  
XPECTRUM

### Order options

LED TYPE	
mid lumen	L
high lumen	M

COLOUR TEMPERATURE	
3000K (CRI ≥ 90)	0
4000K (CRI ≥ 90)	1
3000K (CRI ≥ 80)	5
4000K (CRI ≥ 80)	6
tunable white 2700–6500K*	

\*DALI-2 DT8

CONTROL	
non DIM	1
DALI-2 (only high lumen)	3

MATERIAL COLOUR	
pure white RAL 9010	7
white aluminium RAL 9006	G
jet black RAL 9005	8
special colours p.992	X

LIGHT OPTIC COVER	
opal high performance	H
microprismatic	Z
microprismatic (UGR ≤ 19)*	G
blind cover**	B

\*UGR ≤ 19 only with mid lumen

\*\*only for channel corner 90°

EMERGENCY LIGHT	
1h Accupack	N L 1
3h Accupack	N L 3

### Options on request

COLOUR RENDERING INDEX	
CRI ≥ 98 XPECTRUM	

LUMINOUS FLUX value calculated for CRI ≥ 80, colour white, cover opal microprism. Z -8%, microprism. G -10%

### MINO 100 ceiling / suspended

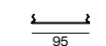
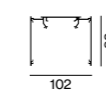

INSTALLATION CHANNEL / CORNER 90°	L (mm)	ORDER CODE
channel	1172	034-0126
channel	1472	034-0156
channel	3000	034-0306
channel	custom	E85050
channel corner 90° + cover	200x200	034-1266

LIGHT OPTIC COVER / BLIND COVER	L (mm)	ORDER CODE
linear	1171	006-12122
linear	1470	006-12152
linear	2997	006-12302
linear	custom	E80650
blind cover	3000	006-1130
blind cover	custom	E80650

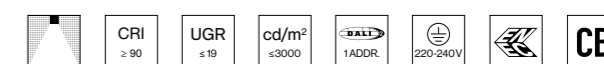

LIGHT INSET 100	L (mm)	ORDER CODE
SYSTEM POWER (MID/HIGH LUMEN)		
8.7/13.8W	571	007-862
13/20.6W	871	007-863
15.3/27.5W	1171	007-864
19.2/34W	1463	007-865
31/55W	2341	007-868
38/68W	2997	007-869
15.3/27.5W flex	660-1171	007-86F
31/55W flex	1903-2341	007-86G

COVER	COLOUR TEMP.	SYSTEM POWER	DELIVERED LUMENS	EFFICACY
mid lumen/opal	3000K	14 W/m	1770 lm/m	132 lm/W
high performance	4000K		1870 lm/m	140 lm/W
high lumen/opal	3000K	24 W/m	2920 lm/m	123 lm/W
high performance	4000K		3090 lm/m	130 lm/W

LIGHT INSET 100 tunable white 2700–6500K	L (mm)	ORDER CODE
SYSTEM POWER		
21.7W	871	007-8633D37
29W	1171	007-8634D37
36W	1463	007-8635D37
58W	2341	007-8638D37

### Accessories

END CAPS	ORDER CODE
TYPE	
end caps (pair)	034-1306

LINEAR CONNECTOR / THROUGH WIRE	ORDER CODE
TYPE	
linear connector (1 piece)	005-40066
linear connector (10 pieces)	005-40066.10
opal cover linear connector	006-10000
through wire 3 × 1.5 mm² (non DIM, 10 pieces)	004-90003
through wire 5 × 1.5 mm² (DALI-2, 10 pieces)	004-90005

CEILING CLIP / CABLE SUSPENSION / CANOPY	L (mm)	ORDER CODE
TYPE		
ceiling clip	10	034-11836
cable suspension	1500	005-2132110
canopy / feeder cable 3 × 1.5 mm²	1500	005-221231
canopy / feeder cable 5 × 1.5 mm²	1500	005-221241
cable rail	1200	005-2491110

for electrical system configuration see luminaire data sheet at xal.com

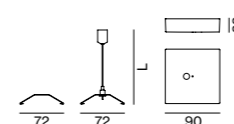
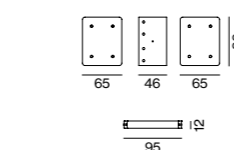
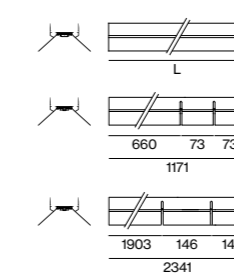





Office Amazon Prague, CZ –  
by HLW with lighting design by U1 lighting

**Compound Semiconductor  
Applications Catapult**  
South Wales, UK –  
by Monteith Scott



# Adjust your profile system

## BASO IP54 system

**EN** BASO IP54 is a powerful profile luminaire that has been specially adapted to demanding environmental conditions: from public outdoor areas to wet rooms. It has increased dust and insect protection (IP54). BASO IP54 is available as a single luminaire or as a system variant. It is easy to install and suitable for recessed or surface fitting as well as for wall or ceiling mounting. An opal cover delivers homogeneous basic illumination. The luminaire has a colour rendering of up to  $CRI \geq 90$  and can be selected with a dark grey or white housing and in two light colours (3000 K and 4000 K).

**IT** BASO IP54 è un potente apparecchio a profilo che è stato appositamente adattato alle condizioni ambientali difficili: spazi pubblici all'aperto o ambienti umidi. Anche la protezione da polvere e insetti è rinforzata (IP54). BASO IP54 è disponibile come modello singolo o da montare in sistema. Si fissa con facilità e si presta all'incasso o al montaggio a plafone su pareti e soffitti. Il rifrattore opale diffonde l'illuminazione in modo uniforme, con un indice di resa cromatica pari a da fino a  $CRI \geq 90$ . La cassaforma si può scegliere di colore bianco o grigio scuro. Sono inoltre disponibili due temperature di colore (3000 K e 4000 K).

### Type



60

### Mountings

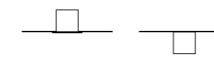
trim  
recessed

surface

### Configurations



linear

corner

### Light distribution

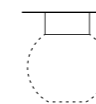

opal

← back



## BASO 60 IP54 system

recessed with trim

EN Luminaire housing made of extruded aluminium; recessed luminaire with trim; suitable for ceiling thickness of 8-20 mm; surface powder coated; suitable for wall or ceiling mounting; luminaire profile (end caps come pre-assembled) can be pre-mounted; remaining luminaire components mounted without tools; closed light insert made of PMMA, consisting of converter unit and circuit board unit; light inset with screwed-on, thus maintenance-friendly, transparent end cap in PMMA; HPO (High Performance Opal) cover for uniform illumination; energy-efficient LEDs with very good colour rendering; IP 67 socket connector system for easy and sealed electrical connection

IT Corpo illuminante in profilo di alluminio estruso; apparecchio da incasso con bordo perimetrale; per file continue; per soffitti di spessore 8-20 mm; verniciatura a polvere; per montaggio a parete o soffitto; profilo apparecchio preassemblabile; restanti componenti montabili senza utensili; inserto luce chiuso in PMMA, costituito da unità convertitore e unità scheda; inserto luce con testata finale in PMMA trasparente avvitata che ne facilita la manutenzione; diffusore HPO (High Performance Opal) per un'illuminazione omogenea; LED ad efficienza energetica con elevata resa cromatica; sistema di innesti IP 67 per collegamento elettrico a tenuta stagna

### Quickinfo

3000K, 4000K  
 CRI ≥ 80, 3 SDCM  
 up to 2340 lm/m  
 up to 125 lm/W  
 L90 @ 50 000h  
 DALI-2  
 opal, IP 54

### Types

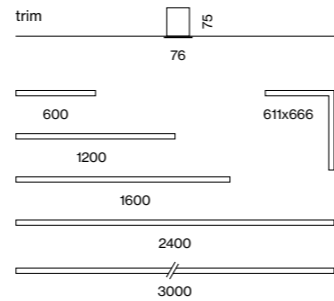

### Colours



### Light distribution

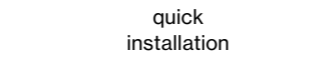

concrete install. housing (p.946)    single luminaire housing (p.558)

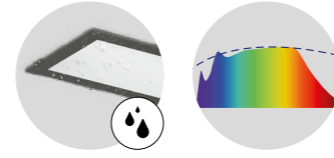

### Order options

COLOUR TEMPERATURE	
3000K	5
4000K	6

CONTROL	
DALI-2	

MATERIAL COLOUR	
○ traffic white RAL 9016	7
● umbra grey RAL 7022	D

LIGHT OPTIC COVER	
opal high performance	

### Options on request

COLOUR RENDERING INDEX	
CRI ≥ 90	

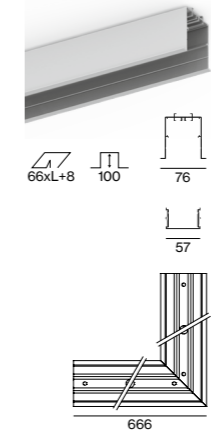

### BASO 60 IP54 trim

INSTALLATION CHANNEL / CORNER 90° / BLIND COVER	L (mm)	ORDER CODE
channel	600	845-340201
channel	1200	845-340401
channel	1600	845-340501
channel	2400	845-340801
channel	3000	845-340901
corner connector 90°	611x666	845-341121
blind cover	600	006-330601
blind cover	1200	006-331201
blind cover	1600	006-331601
blind cover	2400	006-332401
blind cover	3000	006-333001

order installation channel, light inset + mounting accessories separately

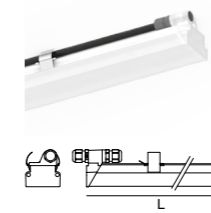

### LIGHT INSET 60 IP54



SYSTEM POWER	L (mm)	ORDER CODE
11.2W start/run	599	845-4042::30H
22.4W start/run	1198	845-4044::30H
29.9W start/run	1597	845-4045::30H
45W start/run	2396	845-4048::30H
11.2W end	599	845-4052::30H
22.4W end	1198	845-4054::30H
29.9W end	1597	845-4055::30H
45W end	2396	845-4058::30H

COVER	COLOUR TEMP.	SYSTEM POWER	DELIVERED LUMENS	EFFICACY
opal high performance	3000K	18.8W/m	2210lm/m	118lm/W
	4000K	18.8W/m	2340lm/m	124lm/W

### Accessories

END CAPS	ORDER CODE
TYPE end caps (pair)	845-341001

MOUNTING BRACKET	ORDER CODE
TYPE mounting bracket (1 piece)	045-3412010
mounting bracket (10 pieces)	045-3412010.10

LINEAR CONNECTOR	ORDER CODE
TYPE linear connector (1 piece)	045-4011110
linear connector (10 pieces)	045-4011110.10

FEEDER CABLE / EXTENSION CABLE / CONNECTOR	L (mm)	ORDER CODE
TYPE feeder cable 2x1.5+2x0.75 mm <sup>2</sup>	2000	845-4013240
feeder cable 2x1.5+2x0.75 mm <sup>2</sup>	4000	845-4013440
extension cable 2x1.5+2x0.75 mm <sup>2</sup>	1200	845-4014140
mini connector 4-pole	-	845-4013040

LUMINOUS FLUX value calculated for CRI ≥ 80, colour white, cover opal

**SNS Headquarters**  
Moscow, RU –  
by ABD Architects with lighting  
design by Light & Design



← back

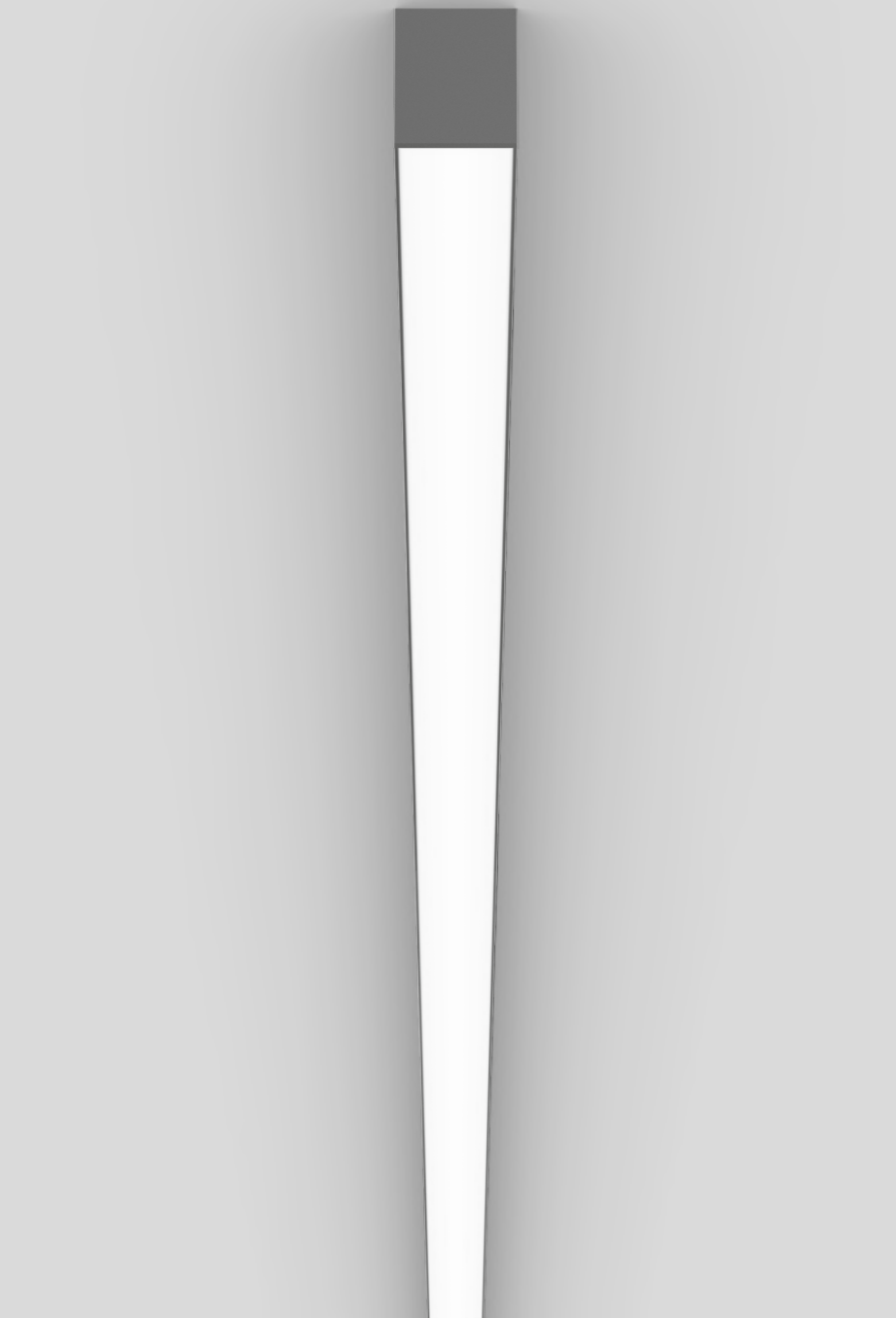

## BASO 60 IP54 system surface

EN Luminaire housing from extruded aluminium profile, angular design; light-tight end caps in aluminium, no visible screws; surface powder coated; suitable for wall or ceiling mounting; luminaire profile (end caps come pre-assembled) can be pre-mounted; remaining luminaire components mounted without tools; closed light insert made of PMMA, consisting of converter unit and circuit board unit; light inset with screwed-on, thus maintenance-friendly, transparent end cap in PMMA; HPO (High Performance Opal) cover for uniform illumination; energy-efficient LEDs with very good colour rendering; IP67 socket connector system for easy and sealed electrical connection

IT Corpo illuminante in profilo di alluminio estruso, modello squadrato; testata di chiusura in alluminio impermeabile alla luce, senza viti a vista; per file continue; verniciatura a polvere; per montaggio a parete o soffitto; profilo apparecchio preassemblabile; restanti componenti montabili senza utensili; inserto luce chiuso in PMMA, costituito da unità convertitore e unità scheda; inserto luce con testata finale in PMMA trasparente avvitata che ne facilita la manutenzione; diffusore HPO (High Performance Opal) per un'illuminazione omogenea; LED ad efficienza energetica con elevata resa cromatica; sistema di innesti IP67 per collegamento elettrico a tenuta stagna

### Quickinfo

3000K, 4000K  
 CRI ≥ 80, 3 SDCM  
 up to 2340lm/m  
 up to 125lm/W  
 L90 @ 50 000h  
 DALI-2  
 opal, IP54

### Types

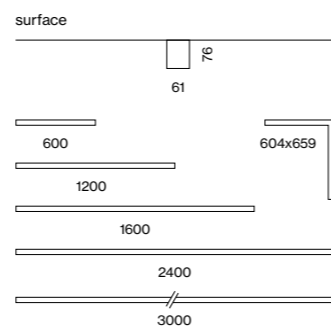

### Colours



### Light distribution



direct



quick installation

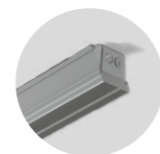

concrete install. housing (p.946)



single luminaire (p.558)



dust & splash water protection (IP54)

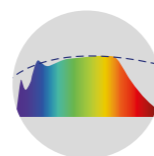

CRI ≥ 98 XPECTRUM

### Order options

COLOUR TEMPERATURE	
3000K	5
4000K	6

### CONTROL

DALI-2

### MATERIAL COLOUR

- traffic white RAL 9016 7
- umbra grey RAL 7022 D

### LIGHT OPTIC COVER

opal high performance

### Options on request

#### COLOUR RENDERING INDEX

CRI ≥ 90

#### MOUNTING

concrete installation housing

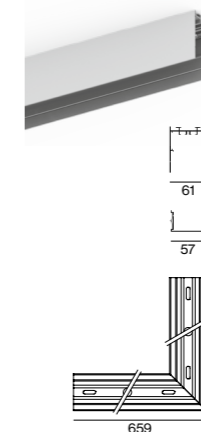

### BASO 60 IP54 surface

#### INSTALLATION CHANNEL / CORNER 90° / BLIND COVER

TYPE	L (mm)	ORDER CODE
channel	600	845-400201
channel	1200	845-400401
channel	1600	845-400501
channel	2400	845-400801
channel	3000	845-400901
corner connector 90°	604x659	845-401121
blind cover	600	006-330601
blind cover	1200	006-331201
blind cover	1600	006-331601
blind cover	2400	006-332401
blind cover	3000	006-333001

order installation channel, light inset + mounting accessories separately

#### LIGHT INSET 60 IP54



SYSTEM POWER	L (mm)	ORDER CODE
11.2W start/run	599	845-4042::30H
22.4W start/run	1198	845-4044::30H
29.9W start/run	1597	845-4045::30H
45W start/run	2396	845-4048::30H
11.2W end	599	845-4052::30H
22.4W end	1198	845-4054::30H
29.9W end	1597	845-4055::30H
45W end	2396	845-4058::30H

COVER	COLOUR TEMP.	SYSTEM POWER	DELIVERED LUMENS	EFFICACY
opal high performance	3000K	18.8W/m	2210lm/m	118lm/W
	4000K	18.8W/m	2340lm/m	124lm/W

### Accessories

#### END CAPS



TYPE	ORDER CODE
end caps (pair)	845-401001

#### LINEAR CONNECTOR



TYPE	ORDER CODE
linear connector (1 piece)	045-4011110
linear connector (10 pieces)	045-4011110.10

#### FEEDER CABLE / EXTENSION CABLE / CONNECTOR

TYPE	L (mm)	ORDER CODE
feeder cable 2x1.5+2x0.75 mm²	2000	845-4013240
feeder cable 2x1.5+2x0.75 mm²	4000	845-4013440
extension cable 2x1.5+2x0.75 mm²	1200	845-4014140
mini connector 4-pole	-	845-4013040

LUMINOUS FLUX value calculated for CRI ≥ 80, colour white, cover opal

**Sekundarschule Petermoos**  
Zurich, CH – by Itten+Brechbühl  
AG, Christina Hamming  
including lighting design



← back



# WALLWASHER

inset 60/100

EN Lighting module with specially computed, asymmetrical high gloss reflector for homogeneous vertical lighting; lighting module in aluminium, powder coated, installation without tools

IT Unità luminosa con riflettore brillantato asimmetrico ottimizzato per illuminazione verticale omogenea; unità luminosa in alluminio verniciato a polvere, montaggio senza utensili

## Quickinfo

3000K, 4000K  
CRI ≥ 80, 3 SDCM  
up to 96lm/W  
L80 @ 50 000h  
non DIM, DALI-2

## Types

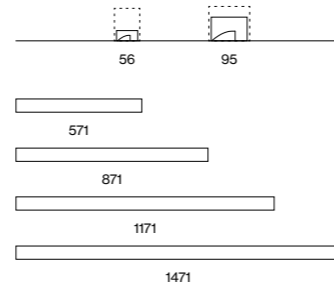

## Colours



## Light distribution



## Order options

COLOUR TEMPERATURE	
3000K	5
4000K	6

CONTROL	
non DIM	1
DALI-2	3

MATERIAL COLOUR	
○ pure white RAL 9010	7
● white aluminium RAL 9006	G
● jet black RAL 9005	8

## LIGHT OPTIC

wallwasher

## Planning information

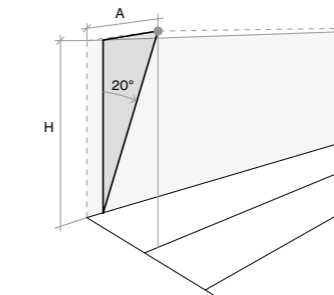

## MOUNTING DISTANCE

H (mm)	A (mm)
2750	900
3000	1000
3500	1200

## Light distribution

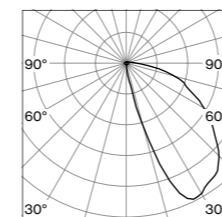

asymmetric

LUMINOUS FLUX value calculated for CRI ≥ 80, colour white, reflector chrome

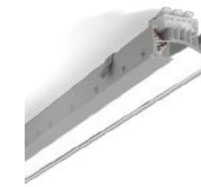

## INSET 60 wallwasher



LIGHT INSET only for recessed or surface mounting

SYSTEM POWER	L (mm)	ORDER CODE
10.6 W	571	007-9042
14 W	871	007-9043
18.7 W	1171	007-9044
28 W	1471	007-9045

## Technical data

SYSTEM POWER	COLOUR TEMPERATURE	DELIVERED LUMENS	EFFICACY
17 W/m	3000 K	1960 lm/m	121 lm/W
	4000 K	2070 lm/m	128 lm/W

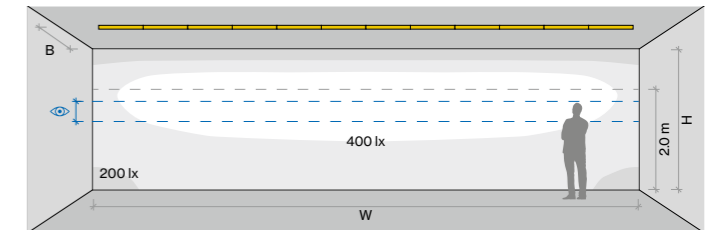

INSET 60 wallwasher, 18.7 W, 3000 K

## CALCULATION SURFACE

Surface dimensions	10.8 × 2.8 m
Surface height	0 – 2.8 m
Eye level	1.35 m – 1.75 m

## ROOM VALUES

Wall dimensions	H = 2.8 m   W = 10.8 m
Distance to wall	B = 1.3 m
Distance between luminaires	continuous
Reflection factor	0.7   0.5   0.2
Maintenance factor	0.8

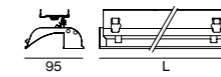

## INSET 100 wallwasher



LIGHT INSET

SYSTEM POWER	L (mm)	ORDER CODE
20 W	571	007-9052
30 W	871	007-9053
40 W	1171	007-9054
51 W	1463	007-9055

## CABLE SUSPENSION

TYPE	L (mm)	ORDER CODE
inset 100 wallwasher	1500	005-2132310

installation channel is required for mounting

## Technical data

SYSTEM POWER	COLOUR TEMPERATURE	DELIVERED LUMENS	EFFICACY
35 W/m	3000 K	2820 lm/m	82 lm/W
	4000 K	2990 lm/m	87 lm/W

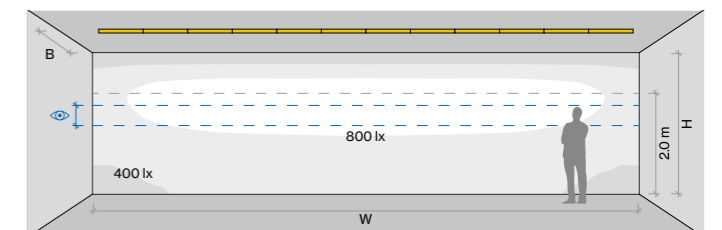

INSET 100 wallwasher, 30 W, 3000 K

## CALCULATION SURFACE

Surface dimensions	10.8 × 2.8 m
Surface height	0 – 2.8 m
Eye level	1.35 m – 1.75 m

## ROOM VALUES

Wall dimensions	H = 2.8 m   W = 10.8 m
Distance to wall	B = 1.3 m
Distance between luminaires	continuous
Reflection factor	0.7   0.5   0.2
Maintenance factor	0.8



← back

**Order options**

NUMBER OF PIECES	
2 pieces	2
3 pieces	3

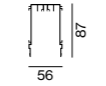

**FRAME 40/MINO 40**

HOUSING FOR CONCRETE INSTALLATION

TYPE	L (mm)	ORDER CODE
FRAME 40 trim	3010	0 0 5 - 4 1 3 5 6
MINO 40	3010	0 0 5 - 4 1 3 5 6

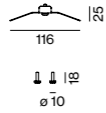

MOUNTING SET

TYPE	ORDER CODE
FRAME 40 trim	0 3 5 - 0 6 0 2
MINO 40	0 3 4 - 0 6 0 2

up to 900 mm: 2 pieces / up to 1500 mm: 3 pieces / up to 3000 mm: 2 x 2 pieces

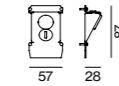

END CAPS

TYPE	ORDER CODE
end caps (pair)	0 0 5 - 4 1 2 3 6

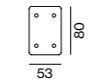

LINEAR CONNECTOR

TYPE	ORDER CODE
linear connector (1 piece)	0 0 5 - 4 1 1 6 6
linear connector (10 pieces)	0 0 5 - 4 1 1 6 6 . 1 0

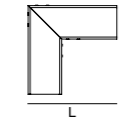

CORNER CONNECTOR 90°

TYPE	L (mm)	ORDER CODE
FRAME 40 trim	140	0 3 5 - 0 6 0 1 6
MINO 40	140	0 3 5 - 0 6 0 1 6

**Order options**

NUMBER OF PIECES	
2 pieces	2
3 pieces	3



**FRAME 60/MINIMAL 60/MINO 60/BASO 60**

HOUSING FOR CONCRETE INSTALLATION

TYPE	L (mm)	ORDER CODE
FRAME 60 trim	3000	0 0 5 - 4 1 3 4 6
BASO 60 IP54 trim	3000	0 0 5 - 4 1 3 4 6
MINIMAL 60 trimless	3000	0 0 5 - 4 1 3 4 6
MINO 60 ceiling	3000	0 0 5 - 4 1 4 4 6
BASO 60 IP54 surface	3000	0 0 5 - 4 1 4 4 6

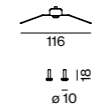

MOUNTING SET

TYPE	ORDER CODE
FRAME 60 trim	0 3 5 - 0 6 0 0
BASO 60 IP54 trim	0 3 5 - 0 6 0 0
MINIMAL 60 trimless	0 3 6 - 0 4 0 0
MINO 60 ceiling	0 3 4 - 0 4 0 0
BASO 60 IP54 surface	0 3 4 - 0 4 0 0

up to 900 mm: 2 pieces / up to 1500 mm: 3 pieces / up to 3000 mm: 2 x 2 pieces



END CAPS

TYPE	ORDER CODE
end caps (pair)	0 0 5 - 4 1 2 4 6



LINEAR CONNECTOR

TYPE	ORDER CODE
linear connector (1 piece)	0 0 5 - 4 1 1 6 6
linear connector (10 pieces)	0 0 5 - 4 1 1 6 6 . 1 0

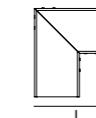

CORNER CONNECTOR 90°

TYPE	L (mm)	ORDER CODE
FRAME 60 trim	142	0 3 5 - 0 4 0 1 6
BASO 60 IP54 trim	142	0 3 5 - 0 4 0 1 6
MINIMAL 60 trimless	146	0 3 6 - 0 4 0 1 6
MINO 60 ceiling	157	0 3 4 - 0 4 0 1 6
BASO 60 IP54 surface	157	0 3 4 - 0 4 0 1 6

**FRAME 100/MINIMAL 100/MINO 100**

HOUSING FOR CONCRETE INSTALLATION

TYPE	L (mm)	ORDER CODE
FRAME 100 trim	3000	0 0 5 - 4 1 3 6 6
MINIMAL 100 trimless	3000	0 0 5 - 4 1 3 6 6
MINO 100 ceiling	3000	0 0 5 - 4 1 4 6 6

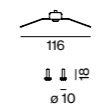

MOUNTING SET

TYPE	ORDER CODE
FRAME 100 trim	0 3 5 - 0 6 0 0
MINIMAL 100 trimless	0 3 6 - 0 5 0 0
MINO 100 ceiling	0 3 4 - 0 4 0 0

up to 900 mm: 2 pieces / up to 1500 mm: 3 pieces / up to 3000 mm: 2x2 pieces



END CAPS

TYPE	ORDER CODE
end caps (pair)	0 0 5 - 4 1 2 6 6



LINEAR CONNECTOR

TYPE	ORDER CODE
linear connector (1 piece)	0 0 5 - 4 1 1 6 6
linear connector (10 pieces)	0 0 5 - 4 1 1 6 6 . 1 0

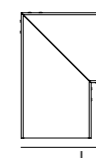

CORNER CONNECTOR 90°

TYPE	L (mm)	ORDER CODE
FRAME 100 trim	202	0 3 5 - 0 5 0 1 6
MINIMAL 100 trimless	207	0 3 6 - 0 5 0 1 6
MINO 100 ceiling	207	0 3 4 - 0 5 0 1 6

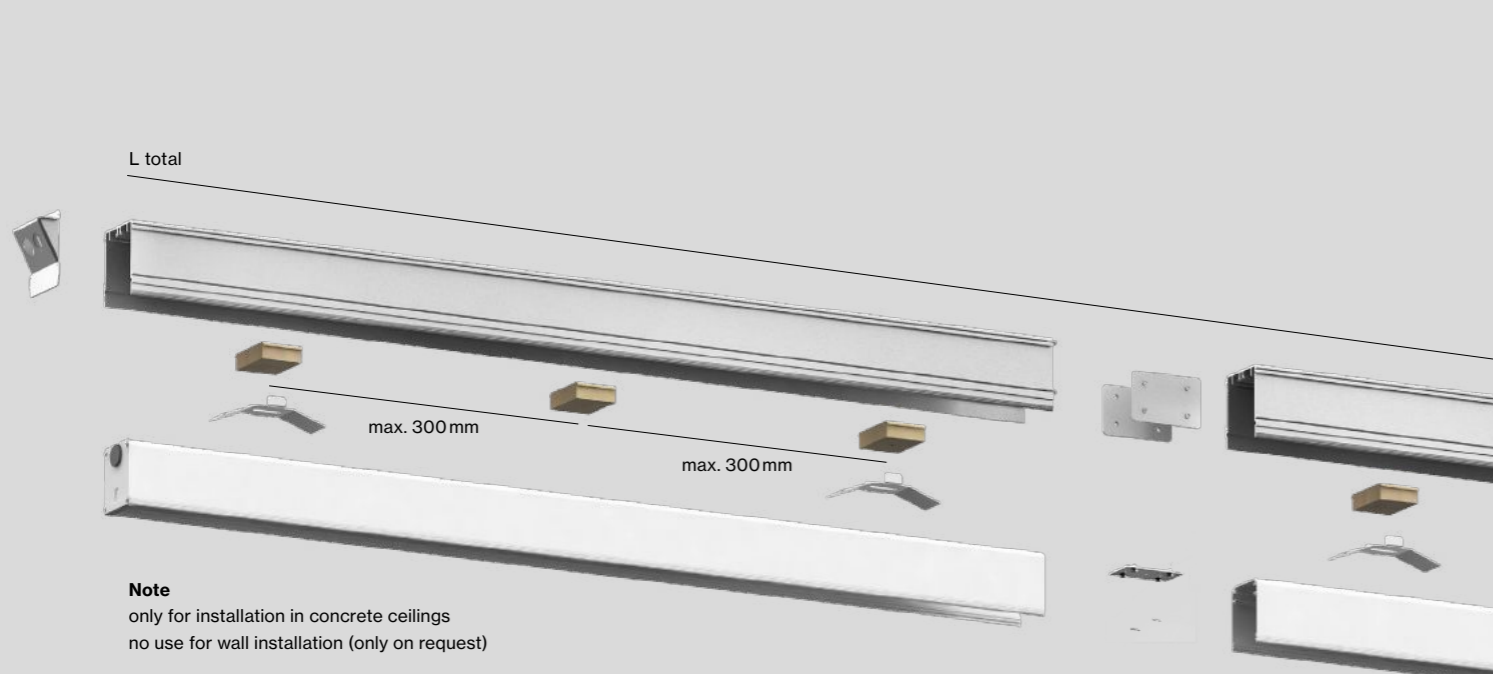

**Note**  
only for installation in concrete ceilings  
no use for wall installation (only on request)

**CONCRETE** installation housing

EN Concrete casting made of aluminium profile, designed for continuous lighting systems

IT Telaio da incasso per calcestruzzo in profilo di alluminio, per sistemi di file continue

# Perfect allrounder

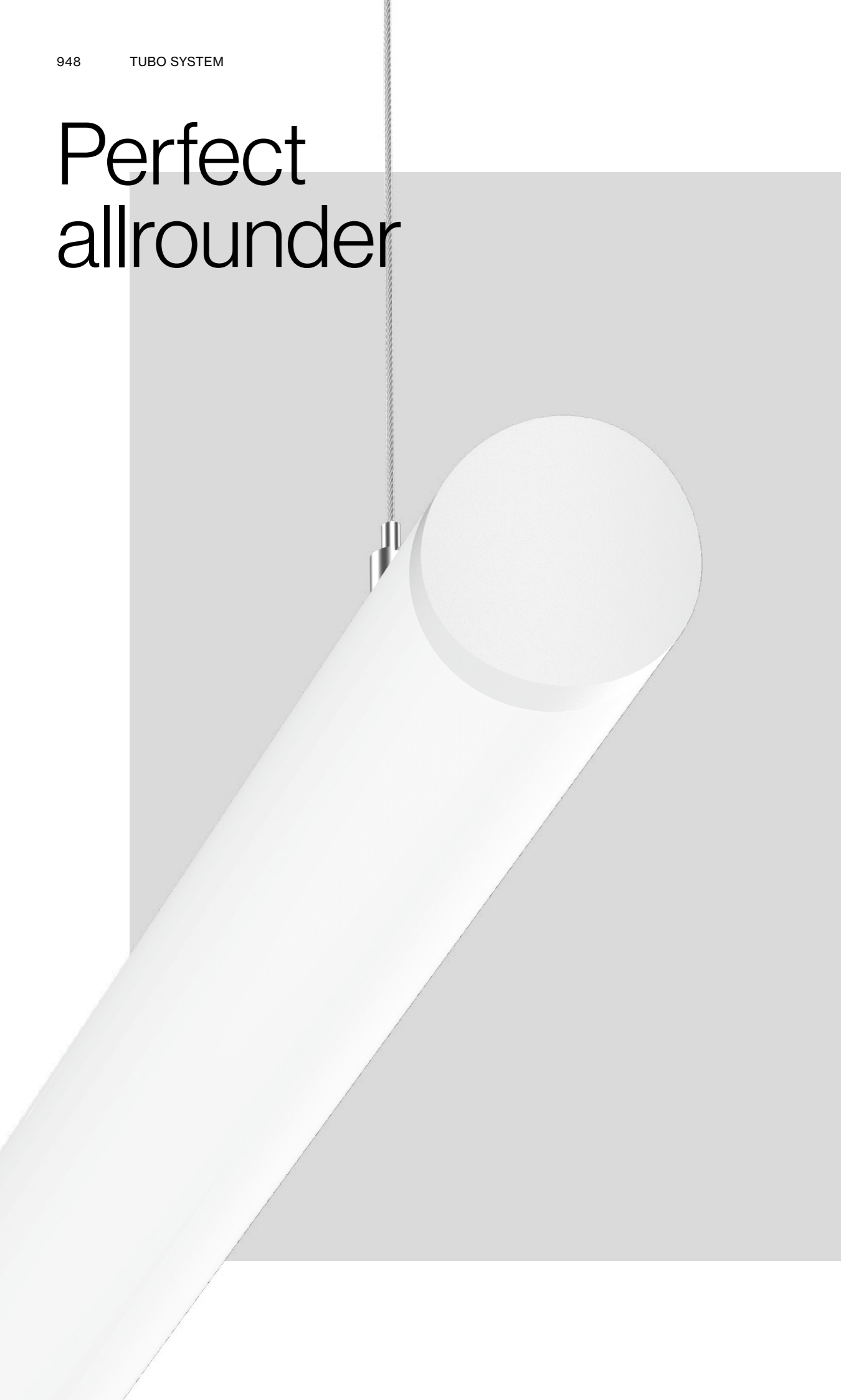

## TUBO system

**EN** As a system luminaire, TUBO scores as a uniform and pleasant lighting system brought to life by linear connecting elements. The luminaire is available for wall and ceiling mounting, as well as in a suspended pendant version. Thanks to the opal cover, the TUBO System luminaire provides uniform ambient lighting and a pleasant atmosphere in entrance areas, corridors, and public spaces. The characteristic beam angle of up to 340° brightens the ceiling slightly while the available light colours 3000K and 4000K boost this positive room atmosphere.

**IT** Con la variante TUBO in sistema si compone un impianto unitario e armonioso servendosi di giunti lineari. L'apparecchio può essere montato a parete e soffitto oppure a sospensione. Il rifrattore opale di TUBO diffonde un'illuminazione generale omogenea creando un'atmosfera piacevole in ambienti come zone d'ingresso, corridoi o aree pubbliche. L'angolo di emissione che caratterizza TUBO arriva a 340°, illuminando il soffitto con un effetto morbido. L'atmosfera gradevole è merito anche delle temperature di colore previste: 3000K o 4000K.

### Types



60

100

### Mountings



surface

suspended

### Light distribution



opal

## 340° light distribution

EN With its 340° beam pattern and opal cover, TUBO System delivers homogeneous illumination as well as slight ceiling brightening. This makes the system luminaire perfect for places where pleasant ambient lighting is desired, such as reception areas, corridors, or foyers.

IT Con un'emissione a 340° e un riflettore opale, TUBO System diffonde un'illuminazione omogenea ed anche una leggera luminosità sul soffitto. Di conseguenza l'apparecchio in sistema è perfetto per gli ambienti dove si cerca un'illuminazione generale piacevole: ad esempio zone d'ingresso, corridoi o foyer.

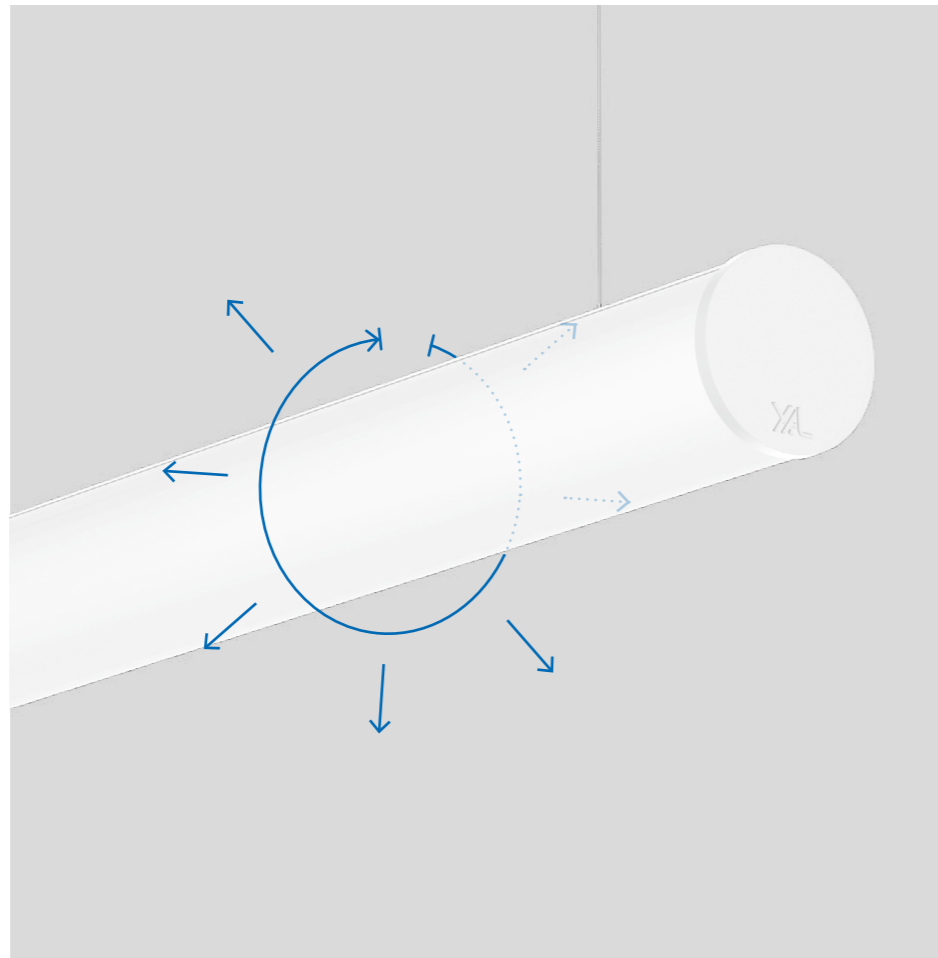

## Mounting options

EN The TUBO System can be installed as a surface-mounted version in a continuous lighting system for walls and ceilings, or as a suspended pendant luminaire on the ceiling.

IT TUBO System si può installare come sistema unitario in variante a plafone, su pareti e soffitti, oppure si può appendere al soffitto con la variante a sospensione.



## Seamless light channel

EN TUBO as a continuous lighting system: Connecting elements can turn individual TUBO luminaires into a seamless channel. This creates a visually uniform lighting system for many different applications – whether as a corridor luminaire, effect luminaire, or visual guidance system.

IT TUBO sa diventare un sistema ininterrotto grazie agli elementi di giunzione che uniscono i singoli apparecchi in una fila continua unica. Ne deriva un impianto otticamente unitario, adatto a molte destinazioni: ad esempio in corridoi, per un'illuminazione d'effetto o anche come sistema di guida visiva.



## Easy mounting

EN TUBO 60 system luminaires are electrically connected by a simple plug-in connection. This makes the installation of a complex lighting system simple, quick, and straightforward.

IT Gli apparecchi in sistema TUBO 60 si collegano elettricamente con semplici innesti. Pertanto il montaggio di un sistema d'illuminazione anche complesso si esegue in modo significativamente semplice, rapido e senza complicazioni.

← back



# TUBO 60 system

surface / suspended

EN Supporting profile in extruded aluminium; end cap in aluminium; for continuous lighting systems; surface powder coated; surface mounted or suspended luminaire with cable suspension; height adjustment without tools; with transparent feeder cable; electrical connection of the luminaires via plug / socket system; no separate wiring required; light control via high-quality lens system for maximum, homogeneous illumination; completely homogeneously illuminated, cylindrical HPO (High Performance Opal) cover; energy-efficient LEDs with very good colour rendering

IT Binario portante in profilo di alluminio estruso; testata di chiusura in alluminio; per file continue; verniciatura a polvere; corpo illuminante a plafone o sospensione con fune; regolazione altezza senza utensili; con cavo di alimentazione trasparente; collegamento elettrico degli apparecchi tramite sistema presa / spina; senza cablaggio separato; controllo della luce con ottica lenticolare di alta qualità per un'illum. omogenea; cover cilindrica HPO (High Performance Opal) illuminata in modo perfett. omogeneo; LED ad efficienza energetica con elevata resa cromatica



## Quickinfo

3000K, 4000K  
CRI ≥ 80, 3 SDCM  
up to 3160lm/m  
up to 114lm/W  
L90 @ 50 000h  
non DIM, DALI-2  
opal

## Types

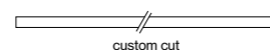
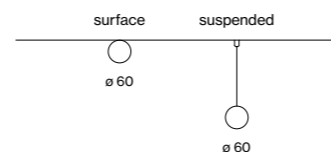

## Colour



## Light distributions



## Order options

COLOUR TEMPERATURE	
3000K	5
4000K	6

CONTROL	
non DIM	1
DALI-2	3

## MATERIAL COLOUR

○ pure white RAL 9010

## TUBO 60 surface / suspended



INSTALLATION CHANNEL + LIGHT INSET + LIGHT OPTIC COVER				
SYS. POWER	COLOUR TEMP.	LUM. FLUX	L (mm)	ORDER CODE
16.5 W	3000K	1780lm	585	058-3022::70
	4000K	1880lm		
33 W	3000K	3560lm	1185	058-3024::70
	4000K	3760lm		
66 W	3000K	7110lm	2385	058-3028::70
	4000K	7530lm		
82 W	3000K	8890lm	2985	058-3029::70
	4000K	9410lm		

## Accessories surface

### END CAP / POWER FEEDER

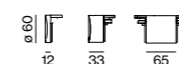

TYPE	ORDER CODE
end cap	058-3010017
end cap power feeder	058-3010217
middle power feeder	058-3011217

### LINEAR CONNECTOR

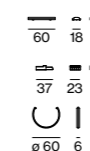

TYPE	ORDER CODE
mechanical	058-3013117
mechanical & electrical	058-3013127
incl. opal cover connector	

### CEILING MOUNTING SET



TYPE	L (mm)	ORDER CODE
ceiling mounting set	75	058-3014117

## Accessories suspended

### END CAP / POWER FEEDER incl. feeder cable

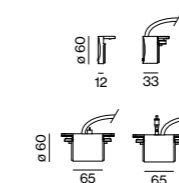

TYPE	ORDER CODE
end cap	058-3010017
end cap power feeder 5 × 1.5 mm <sup>2</sup>	058-3010417
middle power feeder* 5 × 1.5 mm <sup>2</sup>	058-3011317
middle power feeder angular** 5 × 1.5 mm <sup>2</sup>	058-3011327

\*incl. cable suspension 1500 mm

\*\*incl. cable suspension angular max. 60° 1500 mm

### LINEAR CONNECTOR

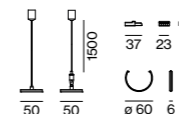

TYPE	ORDER CODE
mechanical*	058-3013217
mechanical angular**	058-3013317
mechanical & electrical*	058-3013227
mechanical & electrical angular**	058-3013327

incl. opal cover connector

\*incl. cable suspension 1500 mm

\*\*incl. cable suspension angular max. 60° 1500 mm

### CABLE SUSPENSION

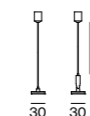

TYPE	L (mm)	ORDER CODE
cable suspension	1500	058-3014210
cable suspension angular max. 60°	1500	058-3014310

### CANOPY



TYPE	Ø-H (mm)	ORDER CODE
non DIM / DALI-2	90-22	005-2600037

for electrical system configuration see luminaire data sheet at xal.com

LUMINOUS FLUX value calculated for CRI ≥ 80, colour white, cover opal

back



## TUBO 100 system

surface / suspended

EN Supporting profile in extruded aluminium; end cap in aluminium, no visible screws; for lighting systems; powder coated; luminaire profile for mounting available in advance; remaining components mounted without tools; surface mounted or suspended luminaire with cable suspension; height adjustment without tools; spring clip attachment to the luminaire; freely positionable; with transparent feeder cable; light inset consisting of highly reflective coated extruded profile for improved thermal management; cylindrical cover made of satinised PMMA for homogeneous illumination; with 340° light emission and light ceiling illumination; energy-eff. LEDs – very good colour rendering

IT Binario portante in profilo di alluminio estruso; testata di chiusura in alluminio, senza viti a vista; per sistemi di illuminazione; verniciatura a polvere; profilo consegnabile in anticIPA; tutti gli altri componenti si fissano senza bisogno di utensili; corpo illuminante a plafone o sospensione con fune; regolazione altezza senza utensili; fissaggio sull'apparecchio tramite clip a molla; libertà di posizionamento; con cavo di alimentazione trasparente; unità d'illuminazione in profilo di alluminio estruso con verniciatura altamente riflettente per gestione termica migliorata; diffusore cilindrico in PMMA satinato per un'illuminazione omogenea; con emissione a 340° e leggera illuminazione del soffitto; LED a risp. energ. – ottima resa cromatica

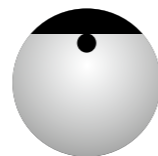
single luminaire  
(p. 576)uniform  
illumination

### Types

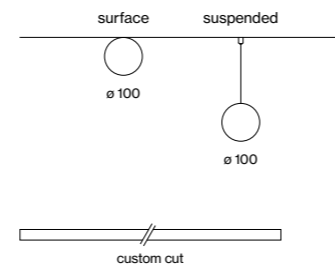

### Colour



### Light distributions



direct direct

### Quickinfo

3000K, 4000K  
CRI ≥ 80, 3 SDCM  
up to 4300lm/m  
up to 138lm/W  
L90 @ 50 000h  
non DIM, DALI-2  
opal

### Order options

COLOUR TEMPERATURE	
3000K	5
4000K	6

CONTROL	
non DIM	1
DALI-2	3

### MATERIAL COLOUR

 pure white RAL 9010

### Options on request

CONTROL
Casambi

### EMERGENCY LIGHT

1h Accupack
3h Accupack

only available for length 1463mm



18.3 W	571	029-8832
27.5 W	871	029-8833
37 W	1171	029-8834
46 W	1463	029-8835
73 W	2341	029-8838

### TUBO 100 ceiling / suspended

#### INSTALLATION CHANNEL

TYPE	L (mm)	ORDER CODE
installation channel	582	029-00667
installation channel	882	029-00967
installation channel	1182	029-01267
installation channel	1482	029-01567
installation channel	2364	029-02567
installation channel	3000	029-03067
installation channel	custom	E85950

#### LIGHT OPTIC COVER OPAL HIGH PERFORMANCE

TYPE	L (mm)	ORDER CODE
light optic cover	577	006-5205700
light optic cover	877	006-5208700
light optic cover	1177	006-5211700
light optic cover	1477	006-5214700
light optic cover	2359	006-5223400
light optic cover	2995	006-5230000
light optic cover	custom	E85910

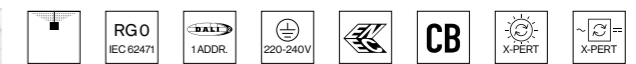

#### LIGHT INSET

SYSTEM POWER	L (mm)	ORDER CODE
18.3 W	571	029-8832
27.5 W	871	029-8833
37 W	1171	029-8834
46 W	1463	029-8835
73 W	2341	029-8838

COVER	COLOUR TEMP.	SYSTEM POWER	DELIVERED LUMENS	EFFICACY
opal high	3000K	31W/m	4060lm/m	131lm/W
performance	4000K		4300lm/m	138lm/W

### Accessories

#### END CAPS

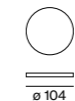

TYPE	ORDER CODE
end caps (pair)	029-14067

#### LINEAR CONNECTOR

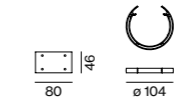

TYPE	ORDER CODE
linear connector (1 piece)	029-12027
linear connector (10 pieces)	029-12027.10
opal cover linear connector	029-12927
anti-slip protection (per cover)	029-00347

#### MOUNTING

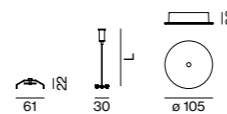

TYPE	L (mm)	ORDER CODE
ceiling mounting set	40	029-00446
cable suspension	1500	005-2142110
angular cable susp. (max. 60°)	1500	005-2142210
canopy / feeder cable 3 × 1.5 mm <sup>2</sup>	1500	005-2222317
canopy / feeder cable 5 × 1.5 mm <sup>2</sup>	1500	005-2222417
cable rail	1200	005-2491110

for electrical system configuration see luminaire data sheet at xal.com

#### THROUGH WIRE

TYPE	ORDER CODE
3 × 1.5 mm <sup>2</sup> (non DIM, 10 pieces)	004-90003
5 × 1.5 mm <sup>2</sup> (DALI-2, 10 pieces)	004-90005

LUMINOUS FLUX value calculated for  
CRI ≥ 80, colour white, cover opal



**UK TV**  
London, UK –  
by PENSON with lighting  
design by AECOM

# Define the horizon



## LINEA system

**EN** Elegant room accentuation, highest performance. LINEA is a reduced, convertible luminaire for stylish wall, floor, and ceiling illumination. The extraordinarily narrow wall profile is completed by various lighting insets. Different beam patterns can be easily combined. For example, an opal cover for homogeneous illumination and asymmetrical illumination for brightening floors or ceilings. Spotlights can be chosen for elegant accentuation or as reading lights. LINEA is available as an individual decorative luminaire in different lengths, including perpendicular corner elements. Choose between white and black for the profile. The inserts optionally have a colour rendering of up to  $CRI \geq 98$ . In addition, the light inserts themselves can be selected in the light colours 2700 K, 3000 K, 4000 K, or as a Tunable White option.

**IT** Accenti suggestivi con il massimo dell'efficacia: LINEA system è un elemento molto ridotto ma flessibile per illuminare con stile pareti, pavimenti e soffitti. Nel profilo ultrasottile si inseriscono vari tipi di inserti luminosi. Il fissaggio è magnetico, sul lato superiore e/o inferiore del profilo, pertanto le unità si sostituiscono facilmente. Le distribuzioni fotometriche si combinano senza problemi: è possibile alternare cover opali per una luce omogenea, elementi per accenti sulle pareti oppure illuminazione asimmetrica di pavimenti e soffitti. LINEA system è disponibile come corpo illuminante singolo, in tre lunghezze, oppure come sistema con giunti angolari. I colori a scelta sono bianco, nero e colori speciali. Per gli inserti luminosi sono previste le temperature di colore 2700 K, 3000 K o 4000 K, intercambiabili in qualsiasi momento.

### Mounting



wall

### Configurations



linear



corner

### Light distributions

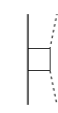
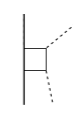
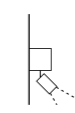
opal  
opalasymmetric  
opal

spot

← back

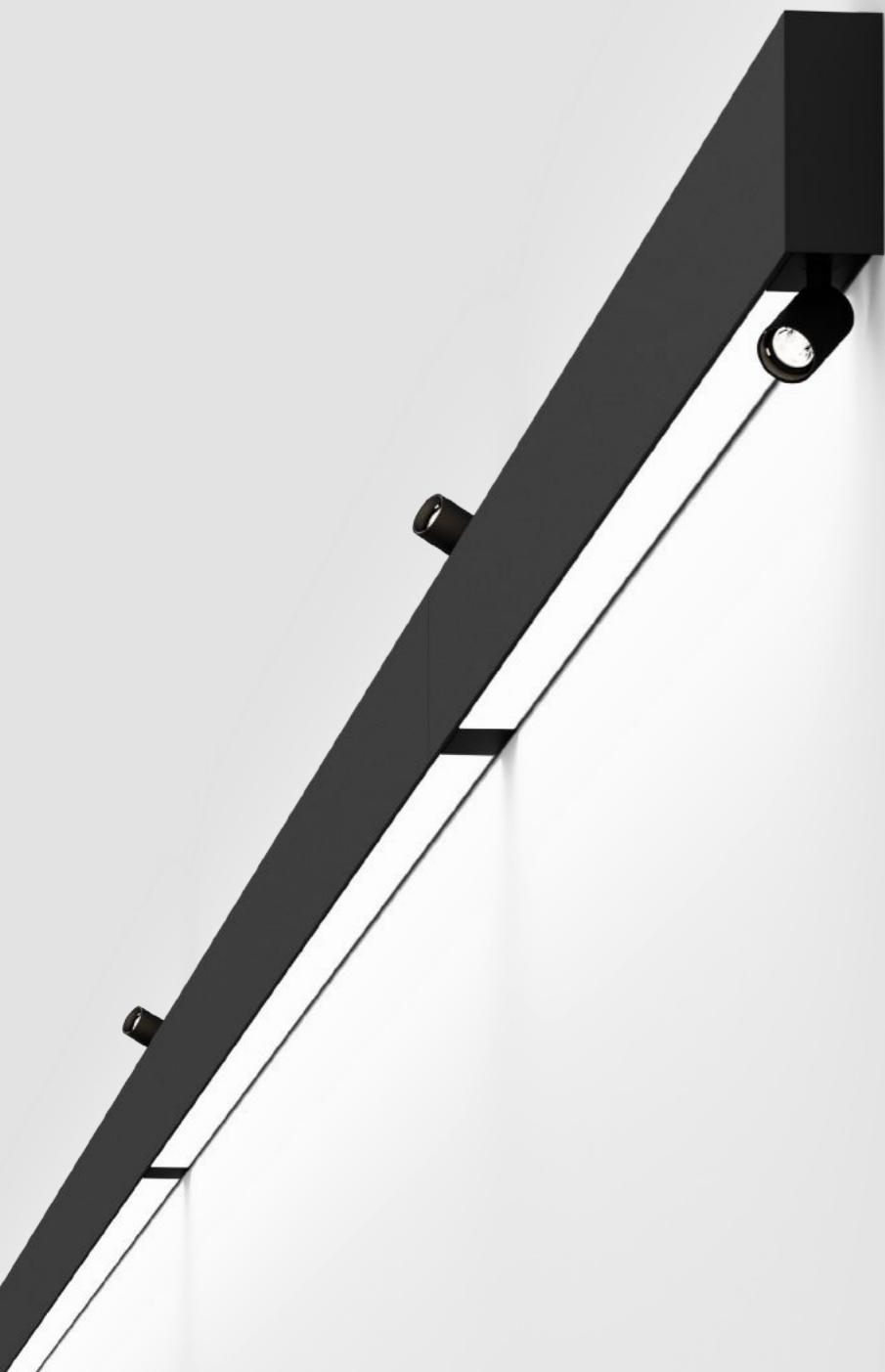

# LINEA system

wall

EN Luminaire housing and front cover from extruded aluminium profile, angular version; no visible screws; designed for continuous lighting systems, 90° angle connectors for flexible system design; surface powder coated; suitable for wall mounting; homogeneous wall or ceiling illumination through uniform direct/indirect light distribution; HPO (High Performance Opal) cover for uniform illumination; or with specially computed, asymmetrical lens for homogeneous lighting intensity (installation optionally for floor or ceiling illumination); energy-efficient LEDs with very good colour rendering; optionally JUST 26 spotlight module can be installed

IT Corpo illuminante e copertura frontale in profilo di alluminio estruso, modello squadrato; nessuna vite visibile; predisposto per file continue, giunto angolare a 90° per composizioni flessibili; verniciatura a polvere; montaggio a parete; distribuzione diretta/indiretta equilibrata per una luminosità omogenea del soffitto o parete; diffusore HPO (High Performance Opal) per un'illuminazione omogenea; o con lente asimmetrica appositamente tarata per livelli di illuminazione omogenei (montaggio per l'illum. pavimento o soffitto a scelta); LED ad efficienza energetica con elevata resa cromatica; inserto faretto JUST 26 montato in opzione

### Quickinfo

3000K, 4000K, TW  
 CRI ≥ 90, 3 SDCM  
 up to 117m/W  
 L90 @ 50 000h  
 non DIM, DALI-2

### Types

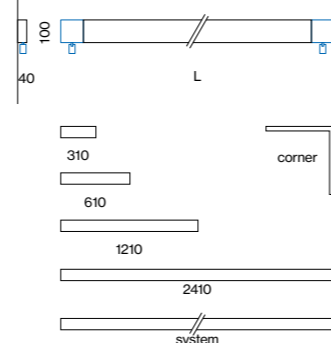

### Colours



### Light distributions

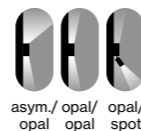

asym./opal/ opal/ opal/ opal spot

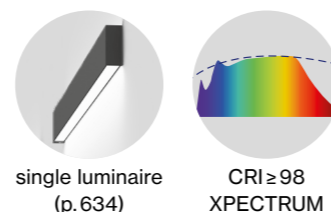

### Order options

COLOUR TEMPERATURE	
3000K	5
4000K	6
tunable white 2700–5000K*	D

\*available from L 1210 mm | DALI-2 DT8

CONTROL	
non DIM	1
non DIM/ switch (only spotlights)	2
DALI-2	3
DALI-2/ switch (only spotlights)	4

MATERIAL COLOUR	
○ pure white RAL 9010	7
● jet black RAL 9005	8

SPOTLIGHT ALIGNMENT	
left	B
right	C

spotlight(s) only with 3000K

### Options on request

COLOUR RENDERING INDEX	
CRI ≥ 98 XPECTRUM	

COLOUR TEMPERATURE	
2700K	

MATERIAL COLOUR	
special colours	

### LINEA system wall

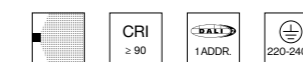

#### ↓ OPAL HIGH PERFORMANCE / ↑ OPAL HIGH PERFORMANCE

SYS. POWER	COLOUR TEMP.	LUMINOUS FLUX	L (mm)	ORDER CODE
14.7W	3000K	↓ 648/± 648lm	310	058-6141::↓↑AH
	4000K	↓ 715/± 715lm		
29.3W	3000K	↓ 1300/± 1300lm	610	058-6142::↓↑AH
	4000K	↓ 1430/± 1430lm		
59W	3000K	↓ 2590/± 2590lm	1210	058-6144::↓↑AH
	4000K	↓ 2860/± 2860lm		
111W	3000K	↓ 5190/± 5190lm	2410	058-6148::↓↑AH
	4000K	↓ 5720/± 5720lm		
29.3W	3000K	↓ 1300/± 1300lm	633x633	058-6111::↓↑AH
	4000K	↓ 1430/± 1430lm		
29.3W	3000K	↓ 1300/± 1300lm	633x633	058-6112::↓↑AH
	4000K	↓ 1430/± 1430lm		

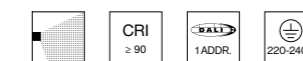

#### ↓ OPAL HIGH PERFORMANCE / ↑ ASYMMETRIC

SYS. POWER	COLOUR TEMP.	LUMINOUS FLUX	L (mm)	ORDER CODE
14.7W	3000K	↓ 648/± 821lm	310	058-6141::↓↑AA
	4000K	↓ 715/± 906lm		
29.3W	3000K	↓ 1300/± 1640lm	610	058-6142::↓↑AA
	4000K	↓ 1430/± 1810lm		
59W	3000K	↓ 2590/± 3280lm	1210	058-6144::↓↑AA
	4000K	↓ 2860/± 3620lm		
111W	3000K	↓ 5190/± 6570lm	2410	058-6148::↓↑AA
	4000K	↓ 5720/± 7250lm		
29.3W	3000K	↓ 1300/± 1300lm	633x633	058-6111::↓↑AA
	4000K	↓ 1430/± 1430lm		
29.3W	3000K	↓ 1300/± 1300lm	633x633	058-6112::↓↑AA
	4000K	↓ 1430/± 1430lm		



#### ↓ OPAL HIGH PERFORMANCE / 1 SPOTLIGHT

SYS. POWER	COLOUR TEMP.	LUMINOUS FLUX	L (mm)	ORDER CODE
29.3W	3000K	↓ 1300/± 1300lm	710	058-6142::↓↑VH
	4000K	↓ 1430/± 1430lm		
59W	3000K	↓ 2590/± 2590lm	1310	058-6144::↓↑VH
	4000K	↓ 2860/± 2860lm		
111W	3000K	↓ 5190/± 5190lm	2510	058-6148::↓↑VH
	4000K	↓ 5720/± 5720lm		

spotlight alignment left or right

### Accessories

END CAPS	
TYPE	ORDER CODE
end caps (pair)	050-254010

CONNECTOR	
TYPE	ORDER CODE
linear connector (1 piece)	050-2551100
linear connector (10 pieces)	050-2551100.10

THROUGH WIRE	
TYPE	ORDER CODE
3 × 1.5 mm <sup>2</sup> (non DIM, 10 pieces)	004-90003
5 × 1.5 mm <sup>2</sup> (DALI-2, 10 pieces)	004-90005

### Light distributions

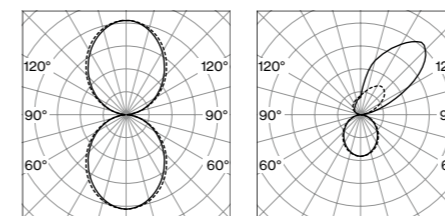

↓ opal high performance  
 ↑ opal high performance

↓ opal high performance  
 ↑ asymmetric

LUMINOUS FLUX value calculated for CRI ≥ 90, colour white, cover opal





**Bedroom**  
Visualisation



**SNS Headquarters**  
Moscow, RU –  
by ABD Architects with lighting  
design by Light & Design

